

NR60E2

Multi-Protocol Networked Resolver Encoder

EtherNet/IP with DLR Interface
PROFINET with MRP Interface
Modbus TCP

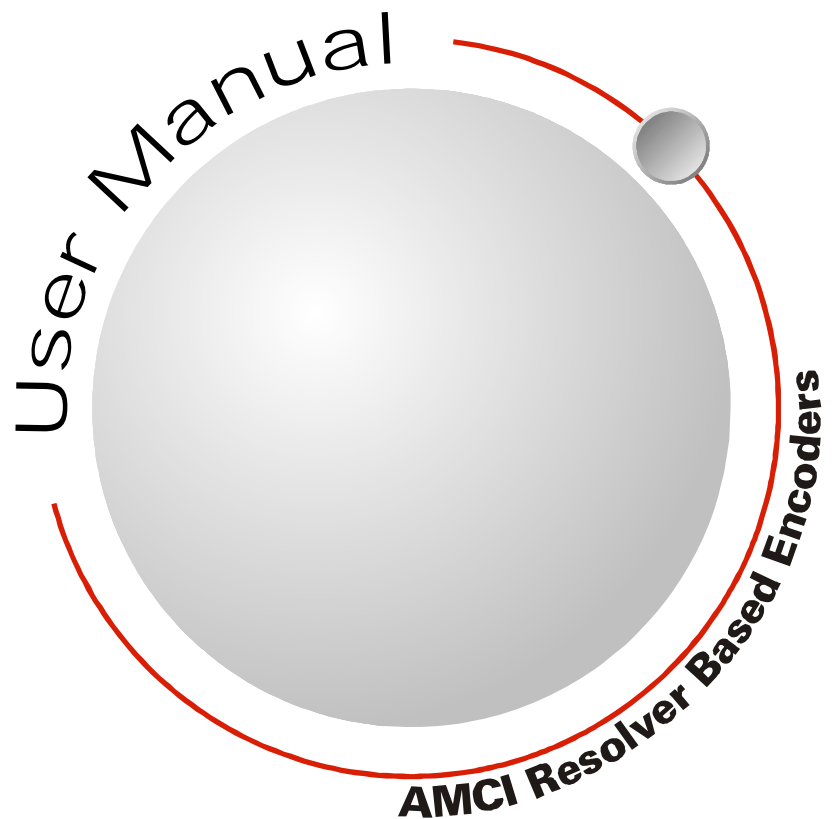

EtherNet/IP



GENERAL INFORMATION

Important User Information

The products and application data described in this manual are useful in a wide variety of different applications. Therefore, the user and others responsible for applying these products described herein are responsible for determining the acceptability for each application. While efforts have been made to provide accurate information within this manual, AMCI assumes no responsibility for the application or the completeness of the information contained herein.

UNDER NO CIRCUMSTANCES WILL ADVANCED MICRO CONTROLS, INC. BE RESPONSIBLE OR LIABLE FOR ANY DAMAGES OR LOSSES, INCLUDING INDIRECT OR CONSEQUENTIAL DAMAGES OR LOSSES, ARISING FROM THE USE OF ANY INFORMATION CONTAINED WITHIN THIS MANUAL, OR THE USE OF ANY PRODUCTS OR SERVICES REFERENCED HEREIN.

No patent liability is assumed by AMCI, with respect to use of information, circuits, equipment, or software described in this manual.

The information contained within this manual is subject to change without notice.

This manual is copyright 2020 by Advanced Micro Controls Inc. You may reproduce this manual, in whole or in part, for your personal use, provided that this copyright notice is included. You may distribute copies of this complete manual in electronic format provided that they are unaltered from the version posted by Advanced Micro Controls Inc. on our official website: www.amci.com. You may incorporate portions of this documents in other literature for your own personal use provided that you include the notice "Portions of this document copyright 2020 by Advanced Micro Controls Inc." You may not alter the contents of this document or charge a fee for reproducing or distributing it.

Standard Warranty

ADVANCED MICRO CONTROLS, INC. warrants that all equipment manufactured by it will be free from defects, under normal use, in materials and workmanship for a period of [18] months. Within this warranty period, AMCI shall, at its option, repair or replace, free of charge, any equipment covered by this warranty which is returned, shipping charges prepaid, within eighteen months from date of invoice, and which upon examination proves to be defective in material or workmanship and not caused by accident, misuse, neglect, alteration, improper installation or improper testing.

The provisions of the "STANDARD WARRANTY" are the sole obligations of AMCI and excludes all other warranties expressed or implied. In no event shall AMCI be liable for incidental or consequential damages or for delay in performance of this warranty.

Returns Policy

All equipment being returned to AMCI for repair or replacement, regardless of warranty status, must have a Return Merchandise Authorization number issued by AMCI. Call (860) 585-1254 with the model number and serial number (if applicable) along with a description of the problem during regular business hours, Monday through Friday, 8AM - 5PM Eastern. An "RMA" number will be issued. Equipment must be shipped to AMCI with transportation charges prepaid. Title and risk of loss or damage remains with the customer until shipment is received by AMCI.

24 Hour Technical Support Number

24 Hour technical support is available on this product. If you have internet access, start at www.amci.com. Product documentation and FAQ's are available on the site that answer most common questions.

If you require additional technical support, call (860) 583-1254. Your call will be answered by the factory during regular business hours, Monday through Friday, 8AM - 5PM Eastern. During non-business hours an automated system will ask you to enter the telephone number you can be reached at. Please remember to include your area code. The system will page an engineer on call. Please have your product model number and a description of the problem ready before you call.

Waste Electrical and Electronic Equipment (WEEE)



At the end of life, this equipment should be collected separately from any unsorted municipal waste.

TABLE OF CONTENTS

General Information

| | |
|--|---|
| Important User Information | 2 |
| Standard Warranty | 2 |
| Returns Policy | 2 |
| 24 Hour Technical Support Number | 2 |
| WEEE Statement | 2 |

About this Manual

| | |
|-----------------------------------|---|
| Audience | 7 |
| Applicable Units | 7 |
| Navigating this Manual | 7 |
| Manual Conventions | 7 |
| Trademarks Acknowledgements | 7 |
| Revision Record | 8 |
| Revision History | 8 |
| Manual Layout | 8 |

Reference: NR60E2 Specifications

| | |
|---------------------------------------|----|
| Overview | 9 |
| Connector Locations and Pinouts | 10 |
| Mating Connectors and Cordsets ... | 10 |
| Status LED's | 11 |
| Network Status (NS) LED | 11 |
| Module Status (MS) LED | 12 |
| Link/Activity LED's | 12 |
| IP Address Switches | 13 |
| Protocol Specific Behavior | 13 |
| Position Reset Switch | 13 |
| Electrical Specifications | 14 |
| Mechanical Specifications | 14 |
| Environmental Specifications | 14 |
| Part Number Description | 15 |
| Available Data | 15 |
| Programmable Parameters | 15 |
| Count Direction | 15 |
| Scaling Function Control | 16 |
| Counts per Turn | 16 |
| Total Measurement Range | 16 |
| Velocity Format | 19 |
| Preset Value | 19 |

Reference: Configuring Network Interfaces

| | |
|--|----|
| Firewall Settings | 21 |
| Disable All Unused Network Interfaces .. | 21 |
| Configure Your Network Interface | 21 |
| Test Your Network Interface | 22 |

Task: Physical Installation

| | |
|--------------------------------------|----|
| Installation Guidelines | 23 |
| Electrostatic Discharge | |
| Prevention | 23 |
| Suitable Environment | 23 |
| Shaft Loading | 23 |
| A Note on Cable Direction | 23 |
| Availability of CAD Drawings | 23 |
| Outline Drawings | 24 |
| Servo Mount, End Connect, | |
| Aluminum or SS Body | 24 |
| Servo Mount, Side Connect, | |
| Aluminum Body Only | 24 |
| Flange Mount, End Connect, | |
| Aluminum or SS Body | 25 |
| Flange Mount, Side Connect, | |
| Aluminum Body Only | 25 |
| Servo and Flange Shaft Details | 26 |
| Hub Shaft Mount, End Connect, | |
| Aluminum or SS Body | 27 |
| Hub Shaft Mount, Side Connect, | |
| Aluminum Body Only | 28 |

Task: Wire Power and Ethernet

| | |
|------------------------------------|----|
| Power Wiring Installation | 29 |
| Power Wiring Guidelines | 29 |
| Connector Location and Pinout | 29 |
| Right Angle Cable | |
| Exit Direction | 29 |
| Mating Connectors and Cordsets .. | 29 |
| CNVL-2M Cable Specifications ... | 30 |
| Ethernet Wiring Installation | 30 |
| Signal Wiring Guidelines | 30 |
| Connector Location and Pinout | 31 |
| Right Angle Cable Exit | |
| Direction | 31 |
| TIA/EIA-568 Color Codes | 31 |
| Mating Connectors and Cordsets .. | 31 |
| Sample Wiring Diagram | 32 |

Task: Set the IP Address and Protocol

| | |
|------------------------------------|----|
| General Guidelines | 33 |
| Web Server Guidelines | 33 |
| Rotary Switch Guidelines | 33 |
| Determine the Best Method for | |
| Setting the IP Address | 34 |
| Use Factory Default Settings | 34 |

| | |
|--|----|
| <i>Task: Set the IP Address and Protocol (continued)</i> | |
| Use the NR60E2 IP Address Switches | 35 |
| Use the Embedded Web Server | 36 |
| Use the AMCI NET Configurator Utility | 39 |
| <i>Protocol Specific Information</i> | |
| Manual Sections | 43 |
| Starting Pages | 43 |
| EtherNet/IP protocol: Page 45 | 43 |
| Modbus TCP protocol: Page 71 | 43 |
| PROFINET protocol: Page 75 | 43 |
| <i>Task: Implicit Communications with an EDS</i> | |
| Obtain the EDS file | 45 |
| Install the EDS file | 45 |
| Start the EDS Hardware | |
| Installation Tool | 45 |
| Install the EDS File | 46 |
| Host System Configuration | 48 |
| Add the NR60E2 to Your Project | 48 |
| NR60E2 Properties | 49 |
| General Tab | 49 |
| Connection Tab | 49 |
| EDS Data Formats | 50 |
| Input Data Format | 50 |
| Buffering the Input Data | 50 |
| Output Data Format | 51 |
| Configuration Data Format | 51 |
| <i>Task: Implicit Communications Without an EDS</i> | |
| Host System Configuration | 53 |
| Add the NR60E2 | 53 |
| Check for Communication Errors | 56 |
| Implicit Messaging Data Format | 56 |
| Assembly Instance = 1 | 56 |
| Assembly Instance = 3 | 57 |
| Buffer Implicit Messaging Data | 57 |
| <i>Task: EtherNet/IP Explicit Messaging</i> | |
| Custom Assembly Instances | 59 |
| Read Assemblies | 59 |
| Write Assemblies | 59 |
| RSLogix 500 Configuration | 60 |
| Add the Read Message Instructions | 61 |
| General Tab Settings | 61 |
| MultiHop Tab Settings | 62 |
| <i>Task: EtherNet/IP Explicit Messaging (continued)</i> | |
| Position and Velocity Data Formats | 62 |
| Assembly Instance = 1 | 62 |
| Assembly Instance = 3 | 62 |
| Add the Write Message Instructions | 63 |
| General Tab Settings | 63 |
| MultiHop Tab Settings | 64 |
| Write Data Formats | 64 |
| Configure NR60E2 Data Format .. | 64 |
| Preset Position Instruction | 65 |
| Save To Flash Instruction | 65 |
| Restore From Flash Instruction | 65 |
| Restore Factory Defaults Instruction | 65 |
| Reset Device Instruction | 65 |
| Troubleshooting | 66 |
| <i>Reference: CIP Position Sensor Object</i> | |
| Common Industrial Protocol | 67 |
| Supported Services | 67 |
| Supported Class Attributes | 67 |
| Supported Instance Attributes | 68 |
| Supported Alarms | 69 |
| <i>Reference: Modbus TCP Configuration</i> | |
| NR60E2 Memory Layout | 71 |
| Supported Modbus Functions | 71 |
| Supported Modbus Exceptions | 72 |
| Multi-Word Format | 72 |
| Output Data Format | 72 |
| Command Word | 73 |
| Configuration Word | 74 |
| Input Data Format | 74 |
| <i>Reference: PROFINET Parameters</i> | |
| PROFINET Parameter Names | 75 |
| Compatibility Mode | 75 |
| Class 4 Functionality | 75 |
| Code Sequence | 75 |
| Scaling Function Control | 75 |
| Measurements Units per | |
| Revolution | 75 |
| Preset Control - G1_XIST1 | 75 |
| Alarm Channel Control | 75 |
| Sign-of-Life Failures | 76 |
| Factory Default Settings | 76 |

Reference: PROFINET Acyclic Data Formats

| | |
|---|----|
| I&M Function | 77 |
| P922 - Telegram Selection | 77 |
| P925 - Maximum life sign failures that may be tolerated | 77 |
| P964 - Device Identification | 78 |
| P965 - Profile Identification | 78 |
| P971 - Store local parameters to non-volatile memory | 78 |
| P974 - Base Mode Parameter Access Service Identification | 79 |
| P975 - DO Identification | 79 |
| P979 - Sensor Format | 79 |
| P980 - Number List of Defined Parameters | 80 |
| P65000 - Preset Value | 80 |
| P65001 - Operating Status | 81 |
| P65001[1] - Operating Status | 81 |
| P65001[2,3] - Supported Faults | 82 |

Reference: PROFINET Cyclic Data Formats

| | |
|--|----|
| Sensor Control Word (G1_STW) | 83 |
| Encoder Control Word (STW2_ENC) | 84 |
| Sensor Status Word (G1_ZSW) | 84 |
| Encoder Status Word 2 (ZSW2_ENC) | 85 |
| Position Data Formats | 86 |
| G1_XIST1 and G1_XIST3 | 86 |
| G1_XIST2 | 86 |
| Velocity Data Format | 86 |
| Standard Telegram 81 | 87 |
| Output Data | 87 |
| Input Data | 87 |
| Standard Telegram 82 | 87 |
| Output Data | 87 |
| Input Data | 87 |
| Standard Telegram 83 | 88 |
| Output Data | 88 |
| Input Data | 88 |
| Standard Telegram 84 | 88 |
| Output Data | 88 |
| Input Data | 88 |
| AMCI Telegram 860 | 89 |
| G1_XIST_PRESET_A | 89 |
| Output Data | 89 |
| Input Data | 89 |

Task: PROFINET Network Configuration

| | |
|--|----|
| Basic Steps | 91 |
| Download the GSDML file | 91 |
| GSDML File Installation | 91 |
| Configure the PROFINET Network | 91 |
| Add the NR60E2 to the PROFINET Network | 92 |
| Set the Telegram | 94 |
| Set the NR60E2 Parameters | 95 |
| Set the NR60 Device Name | 96 |
| Verify and Download the New Configuration | 96 |
| MRP Installations | 97 |
| Configure the NR60E2 as an MRC | 97 |

Notes

ABOUT THIS MANUAL

Read this chapter to learn how to navigate through this manual and familiarize yourself with the conventions used in it. The last section of this chapter highlights the manual's remaining chapters and their target audience.

Audience

This manual explains the installation and operation of AMCI's NR60E2 Multi-Protocol Networked Resolver Encoders. It is written for the engineer responsible for incorporating the NR60E2 into a design as well as the engineer or technician responsible for its actual installation.

Applicable Units

This manual is applicable to all Ethernet NR60E2 units. Every NR60E2 supports EtherNet/IP and Modbus TCP. Units sold after September 1st, 2019, most likely support the PROFINET protocol and have a built-in webserver for IP address configuration. Contact AMCI if you require assistance in determining which protocols are supported by your NR60E2.

Navigating this Manual

This manual is designed to be used in both printed and on-line forms. Its on-line form is a PDF document, which requires Adobe Acrobat Reader version 7.0+ to open it. You are allowed to select and copy sections for use in other documents and, if you own Adobe Acrobat version 7.0 or later, you are allowed to add notes and annotations. If you decide to print out this manual, all sections contain an even number of pages which allows you to easily print out a single chapter on a duplex (two-sided) printer.

Manual Conventions

Three icons are used to highlight important information in the manual:



NOTES highlight important concepts, decisions you must make, or the implications of those decisions.



CAUTIONS tell you when equipment may be damaged if the procedure is not followed properly.



WARNINGS tell you when people may be hurt or equipment may be damaged if the procedure is not followed properly.

The following table shows the text formatting conventions:

| Format | Description |
|------------------------|---|
| Normal Font | Font used throughout this manual. |
| <i>Emphasis Font</i> | Font used for parameter names and the first time a new term is introduced. |
| <i>Cross Reference</i> | When viewing the PDF version of the manual, clicking on a blue cross reference jumps you to referenced section of the manual. |
| <i>HTML Reference</i> | When viewing the PDF version of the manual, clicking on a red cross reference opens your default web browser to the referenced section of the AMCI website if you have Internet access. |

Trademarks Acknowledgements

The AMCI logo is a trademark of Advanced Micro Controls Inc. "PROFINET" is a registered trademark of PROFIBUS & PROFINET International (PI). "CIP" is a trademark of Open DeviceNet Vendor Association, Inc. "EtherNet/IP" is a trademark of ControlNet International, Ltd. under license by Open DeviceNet Vendor Association, Inc. "Adobe" and "Acrobat" are registered trademarks of Adobe Systems Incorporated. All other trademarks contained herein are the property of their respective holders.

Revision Record

This manual, 940-0D161 is the second release of this manual. It adds information on the stainless steel versions of the NR60E2. It was first released on July 7th, 2020.

Revision History

940-0D160: 08/09/2019 Initial Release

Manual Layout

You will most likely read this manual for one of two reasons:

- ▶ If you are curious about the NR60E2, this manual contains the information you need to determine if the NR60E2 is the right product for your application. Chapter 1, NR60E2 Specifications, was written for you. The chapter contains all of the information you will need to fully specify the NR60E2 product in your application.
- ▶ If you need to install and use the NR60E2, then the rest of the manual is written for you. To simplify installation and configuration, the rest of the manual is broken down into *tasks* and *references*. The tasks that are common to all protocols, such as installation, are at the beginning of the manual. e.

| Chapter Title | Starting Page | Chapter Description |
|---|---------------|--|
| <i>NR60E2 Specifications</i> | 9 | Complete specifications of the NR60E2 products. |
| <i>Configuring Network Interfaces</i> | 21 | Information on configuring network interfaces on your computer or laptop to ensure easy communication with the NR60E2. |
| <i>Physical Installation</i> | 23 | Task instructions and information related to physically installing the NR60E2 in your system. |
| <i>Wire Power and Ethernet</i> | 29 | Task instructions and information needed to wire power and ethernet connections to the NR60E2. These instructions are applicable to both bench top and machine wiring. |
| <i>Set the IP Address and Protocol</i> | 33 | Task information on setting the IP address information and selecting the proper protocol for the NR60E2. |
| <i>Implicit Communications with an EDS</i> | 45 | Task information on using an EDS file to configure implicit communications with the NR60E2 using the EtherNet/IP protocol. |
| <i>Implicit Communications Without an EDS</i> | 53 | Task information on configuring the NR60E2 as a generic device for implicit communications using the EtherNet/IP protocol. |
| <i>EtherNet/IP Explicit Messaging</i> | 59 | Task information on using Message Instructions for explicit communications with an NR60E2 encoder using the EtherNet/IP protocol |
| <i>CIP Position Sensor Object</i> | 67 | Reference information on the EtherNet/IP CIP Position Sensor Object definition supported by the NR60E2. |
| <i>Modbus TCP Configuration</i> | 71 | Reference information on communicating with an NR60E2 that is configured to use the Modbus TCP protocol. |
| <i>PROFINET Parameters</i> | 75 | Reference information on the additional parameters used by the NR60E2 when it is configured to use the PROFINET protocol. |
| <i>PROFINET Acyclic Data Formats</i> | 77 | Reference information on the format of data that can be written to the NR60E2 using the acyclic PROFINET communications channel. |
| <i>PROFINET Cyclic Data Formats</i> | 83 | Reference information on the telegrams that can be used to exchange information with the NR60E2 using the cyclic PROFINET data channel. |
| <i>PROFINET Network Configuration</i> | 91 | Task information on adding an NR60E2 to a PROFINET system. |

NR60E2 SPECIFICATIONS

Overview

The NR60E2 is a line of heavy-duty resolver based encoder products from AMCI. The NR60E2 networked resolver encoders communicate over a wired Ethernet network using the EtherNet/IP, PROFINET, or Modbus TCP communications protocol.

The NR60E2 resolver based encoder is a direct upgrade for optical encoders. Instead of a glass disk and associated optics, the primary position sensor in an NR60E2 is an absolute resolver. Resolvers are absolute, single turn position sensors that are constructed in a manner similar to rotary transformers. They are manufactured from passive components, with enameled copper wire and metal laminations the primary components. Additional information on the workings of a resolver can be found on the AMCI website at: <https://www.amci.com/industrial-automation-resources/plc-automation-tutorials/what-resolver>



Figure R1.1 NR60E2 Resolver Based Encoder

The NR60E2 series is composed of absolute single- or multi-turn sensors in an IP67 rated, 60 mm diameter package. All NR60E2 Networked Resolvers offer a maximum single turn position resolution of 16 bits, which is programmable from 1 to 65,536 counts per turn. Two multi-turn units are available in addition to the single turn NR60E2. One encodes 4,096 turns (12 bit + 16 bit = 28 bit encoder) and the other encodes 16,384 turns (14 bit + 16 bit = 30 bit encoder). Multi-turn sensing is through an absolute magnetic encoder.

A flange mount unit with end connectors is shown in figure R1.1. The following mounting styles are available:

- 2.5 inch standard flange mount with 0.375", 0.250", or 10 mm shafts
- 58 mm standard servo mount with 6 or 10 mm shafts
- 63 mm standard blind shaft mount with 0.375", 0.250", 10 mm, or 12 mm diameter hubs

The body material is either aluminum with a powder coat finish, or stainless steel. Side and end connect versions of these mounting styles are available with aluminum bodies. Stainless steel bodies are only available in end connect versions. Outline drawings of all of the packing options are available in the [Outline Drawings](#) section of the manual starting on page 24.

Each NR60E2 encoder has two external network connections using industry standard M12 D-coded connectors. These two ports are internally connected through an onboard, two port, 10/100 Mbps ethernet switch.

Every NR60E2 resolver based encoder is programmable over its Ethernet interface. Parameters allow you to set the count direction, the number of counts per turn, the number of counts before returning to zero, the format of the velocity data, and preset the position data to any value within its range.

When configured as an EtherNet/IP device, the NR60E2 implements the Encoder Device Profile as defined by the CIP Specification revision 2. Custom Assembly instances simplify working with the NR60E2, but the encoder also supports the CIP Position Sensor Object. Its dual Ethernet ports allows the NR60E2 to participate in DLR networks as a Beacon-Based Ring Node that can process beacon packets every 400 microseconds.

When configured as a Modbus TCP device, the NR60Es supports a variety of Modbus Functions to simplify reading and writing the device.

When configured as a PROFINET device, the NR60E2 encoder fully supports the Class 3 V4.1 specification. In addition, NR60E2 encoders support the Class 4 MUR, TMR, Code Sequence, and Preset parameters as well as their additional control parameters. Its dual Ethernet ports allows the NR60E2 encoder to be used as clients in PROFINET networks that support the Media Redundancy Protocol (MRP).

Connector Locations and Pinouts

Figure R1.2 below shows the location of the power and Ethernet connectors on the end connect and side connect units. It also shows the cable exit direction when right angle connectors are used with the NR60E2 units.

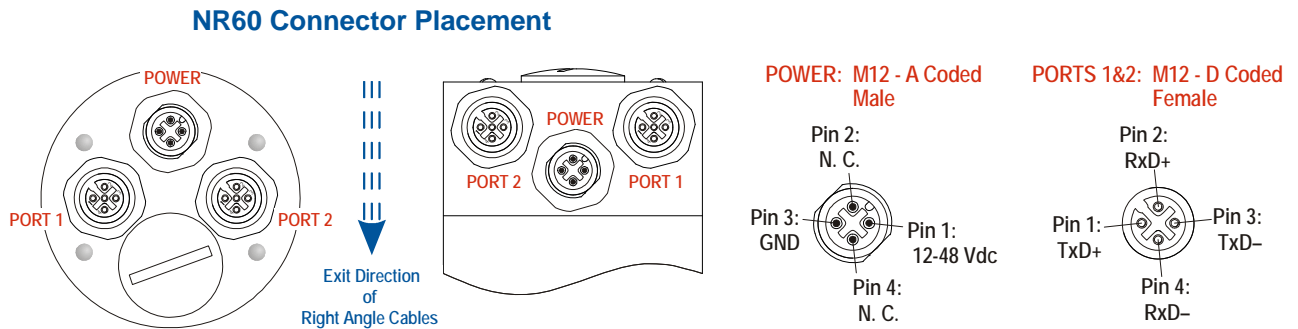

Figure R1.2 Connector Location and Pinout

Mating Connectors and Cordsets

The following mating connectors are available from AMCI. Note that any commercially available M12 connectors with the proper coding and contacts can be used.

| AMCI # | Description |
|--------|---|
| MS-28 | Mating connector for Ethernet port connector. Screw terminal connections. 6 to 8 mm dia. cable. Straight, IP67 rated when properly installed. |
| MS-29 | Mating connector for Power connector. Screw terminal connections. 6 to 8 mm dia. cable. 18 AWG max. Straight, IP67 rated when properly installed. |

Table R1.1 Available Mating Connectors

AMCI offers the following cordsets for use with the NR60E2.

| AMCI # | Description |
|---------|--|
| CNER-5M | Molded cordset for Ethernet connector. 5 meters in length. Straight M12 4 pin D-coded to RJ-45 connector. IP67 rated when properly installed. |
| CNVL-2M | Molded cordset for Power connector. 22 AWG wire, 2 meters in length. Straight A-coded connector to flying leads. IP67 rated when properly installed. |

Table R1.2 Available Cordsets

Status LED's

All NR60E2 resolver based encoders have four status LED's to help you determine the state of the device. These LED's are always located on the back cover of the NR60E2.

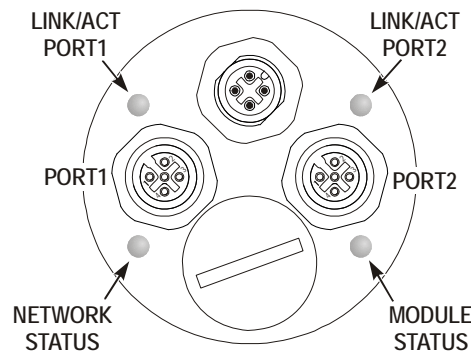

NR60 Rear Cover

E01 Rear Cover shown as example. Status LED locations remain the same regardless of cover type.

Figure R1.3 Status LED Locations

Network Status (NS) LED

The Network Status LED is a bi-color red/green LED. The LED states depends upon the enabled communications protocol.

| LED State | EtherNet/IP Definition | Modbus TCP Definition | PROFINET Definition |
|-----------------------|--|---|--|
| Off | No Power | No power or no TCP connections | No power, duplicate IP address on the network, mismatch in Device Name, or no connection to IO Controller. |
| Alternating Red/Green | Power up Self-Test | Power up Self-Test | Power up Self-Test |
| Flashing Green | Ethernet connection, but no CIP connections | Indicates number of connections with 2 second delay between group. The SMD17E2 supports up to 5 concurrent connections. | On-line, Stop state. A connection with the IO Controller is established and it is in its STOP state. |
| Steady Green | Valid Ethernet network and CIP connections | Should not occur. LED should always flash when network is connected. | On-line, Run state. A connection with the IO Controller is established and it is in its RUN state. |
| Flashing Red | If the MS LED is steady green: Network Connection Timeout | Not Implemented | Not Implemented |
| | If the Module Status LED is also flashing red, the IP Address or Network Protocol has been changed. Cycle power to the unit to continue. | | |
| Steady Red | Duplicate IP address on network. | | Not Implemented. |

Table R1.3 Network Status LED States

*Status LED's (continued)***Module Status (MS) LED**

The Module Status LED is a bi-color red/green LED. The LED states depends upon the enabled communications protocol.

| LED State | EtherNet/IP Definition | Modbus TCP Definition | PROFINET Definition |
|-----------------------|---|--------------------------------------|--|
| Off | No Power | No Power | No power |
| Alternating Red/Green | Initializing: Power up Self-Test | | |
| | Communications failure. There is a communications error between the main processor and the ethernet co-processor within the unit. You must cycle power to the NR60E2 to attempt to clear this fault. | | |
| Flashing Green | Initializing: Waiting for valid physical connection to the network. | | |
| | Successful write to flash memory. Power must be cycled to the unit before additional commands can be written to it. | | |
| Steady Green | Encoder and Network are operational. | Encoder and Network are operational. | Device Name or IP Address are set. |
| Flashing Red | Initializing: IP Address Conflict | | Initializing: Device Name or IP Address are not set. |
| | If the Network Status LED is also flashing, the IP Address or Network Protocol has been changed. Cycle power to the unit to continue. If the Network Status LED is in any other state, a write to flash memory has failed. Cycle power to the unit to clear this fault. | | |

Table R1.4 Module Status LED States

Link/Activity LED's

Each port has an orange Link/Activity LED. An LED is on when an Ethernet hardware connection exists on the port and blinks when there is Ethernet activity on the network segment. Note that this LED shows the hardware state of the network, and is not affected by the enabled protocol.

IP Address Switches

IP address switches are located on the back of the unit behind a sealed plug. Figure R1.4 shows the location of the switches once the plug has been removed.

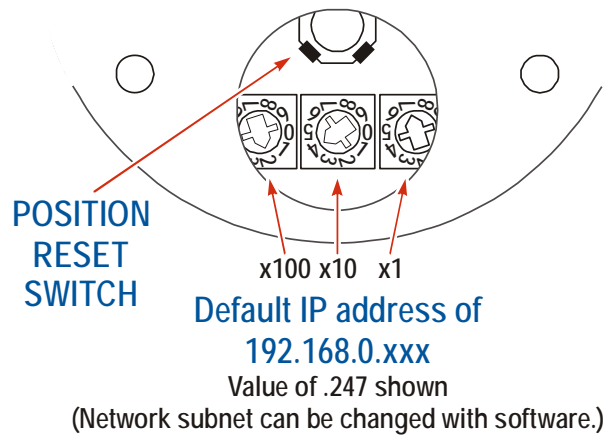

Figure R1.4 IP Address Switch Locations

- ▶ When the IP Address Switches are set to a value of 001 through 254, the NR60E2 will use the IP Address Switches to set the IP address to nnn.nnn.nnn.xxx, where 'nnn.nnn.nnn' is the last network address stored in the nonvolatile memory of the NR60E2 and 'xxx' is the setting of the switches.
- ▶ When the IP Address Switches are set to a value of 000, the NR60E2 will use the DHCP protocol to request an address from a DHCP master. A DHCP master must be present on the network when using this setting.
- ▶ When the IP Address Switches are set to a value of 255-989, the NR60E2 will use the last IP address saved in nonvolatile memory as its IP address.

NOTE

- 1) Address 990 through 998 are used by the factory when testing the unit. The IP Address Switches should not be set within this range by customers in the field.
- 2) Address 999 is used to set the NR60E2 to a known IP address. If the switches are set to 999, the NR60E2 will use the IP Address of 192.168.0.50 regardless of the value stored in nonvolatile memory

Protocol Specific Behavior

How the NR60E2 uses these switches is dependant on the enabled protocol.

- ▶ **EtherNet/IP:** The NR60E2 uses the switch settings for the protocol address and the internal webserver address.
- ▶ **Modbus TCP:** The NR60E2 uses the switch settings for the protocol address and the internal webserver address.
- ▶ **PROFINET:** The NR60E2 uses the switch settings for the address of the internal webserver address only. The IP address used by the PROFINET protocol is typically assigned to the NR60E2 by the PROFIBUS master when the NR60E2 attaches to the network.

Position Reset Switch

Figure R1.4 also shows the location of the Position Reset Switch. The NR60E2 will reset the reported position to zero when this momentary contact switch is pressed. The resulting internal offset is automatically stored in nonvolatile memory.

*Electrical Specifications***Operating Voltage (External Supply)**

12 Vdc to 48 Vdc nominal
11 Vdc to 54Vdc maximum

Power Requirements

2.5 W max.
100 mA @ 24 Vdc typical

Ethernet Capability

10/100 Mbit autosense with auto-switch capability.
Auto-switch eliminates the need of a crossover cable in all applications.

Network Redundancy

(2) Switched Ethernet ports
Compatible with DLR installations in EtherNet/IP environments. Compatible with MRP installations in PROFINET environments.

Maximum Cable Length

100 meters (330 feet), based on the Ethernet standard

Single Turn Resolution

Programmable from 1 to 65,536 counts per turn
(16 bit resolution max.)

Multi-turn Resolution

4,096 turns (12 bit) or 16,384 (14 bit)

Count Direction

Default of CW increasing when looking at the shaft.

Programmable to CW or CCW increasing.

Preset Position

Position can be preset or offset to any value within its range. The Internal Position Offset can be stored in nonvolatile memory and retrieved on power up.

Position can be reset to zero via momentary contact switch. The resulting position offset is automatically stored in nonvolatile memory.

Positional Accuracy

±10 arc-minutes

*Mechanical Specifications***Package Style**

60 mm housing with flange or servo mounting

Housing

Powder coated aluminum or stainless steel

Connector Location

Side or End for aluminum body. End for stainless steel body

Housing

Powder coated aluminum

Shaft

Flange: 0.375", 0.250", or 10 mm.
Servo: 6 mm or 10 mm with flat on shaft

Max. Starting Torque @ 25°C

2.0 oz-in (1.41 N-cm)

Moment of Inertia

6.0×10^{-4} oz-in-sec² (43.2×10^{-6} kg-cm-sec²)

Max. Operating Speed

6000 RPM max.

Max. Shaft Loading

Axial: 20lbs. (89N)
Radial: 40lbs. (178N)

At specified max. loads, minimum bearing life is 2×10^9 revolutions.

*Environmental Specifications***Operating Temperature**

-40°F to +185°F (-40°C to +85°C)

Shock

50g, 11 millisecond duration

Vibration

20g, 5 to 2000Hz

Enclosure Rating

IP67

Approximate Weight

1.3 lbs. (0.59 kg)

Part Number Description

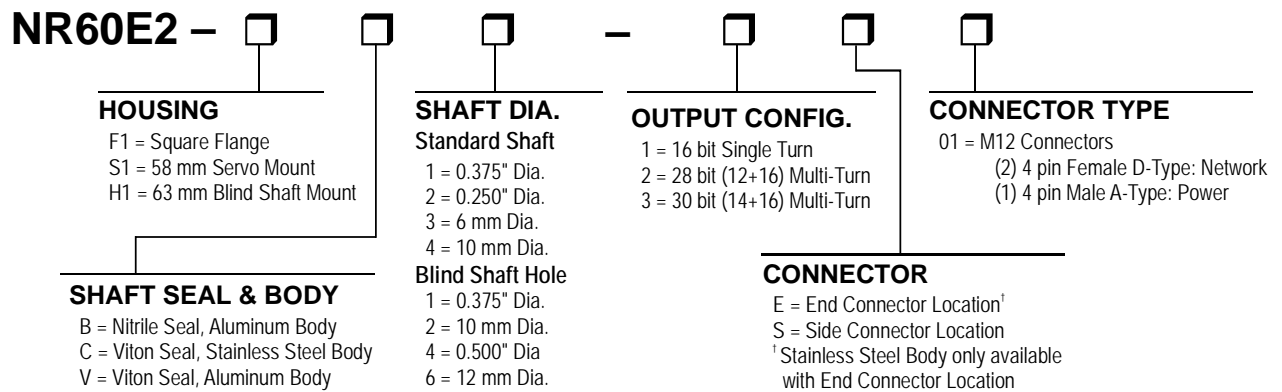

Figure R1.5 Part Number Description

Available Data

All NR60E2 encoders offer position and velocity data that can be scaled with the programmable parameters as described in the following section. The position data can also be preset which allows you to align the position data with your machine position without having to physically rotate the shaft.

Programmable Parameters

The following parameters are available on all NR60E2 encoders. Units configured for the PROFINET protocol, use encoder objects that are defined by these protocols. Therefore, these units have additional parameters that are protocol specific. These parameters are explained in the PROFINET protocol section, **PROFINET Parameters** starting on page 75.

Count Direction

This parameter is called *Code Sequence* in PROFINET systems. This parameter allows you to set the direction of shaft rotation needed to produce increasing counts. The default is CW when looking at the shaft.

Effects of Reversing Count Direction

Changing the *Count Direction* parameter changes the way the position value is calculated. When you reverse the count direction, the position changes from your current position value to (Maximum number of counts – current position value). For example, assume a 30 bit NR60E2 with its default of 65,536 counts per turn. If the current position value is 100,000 and you change the Direction Counting Toggle parameter, the current position will change to $(2^{30} - 100,000 = 1,073,741,824 - 100,000) = 1,073,641,824$.

Most applications do not require you to change the count direction after the machine is setup, so the count direction is typically set before the position value is preset.

Changing the count direction on your machine while maintaining the current position value is a three step process. First, read and store the current position value from the NR60E2. Second, change the *Count Direction* value. Third, write the stored position value back to the NR60E2 as a preset value.

Programmable Parameters (continued)

Scaling Function Control

This parameter determines if the position value reported in the network data is scaled to engineering units or if it is reported at its full 16 bit resolution. Scaling is accomplished with the *Counts per Turn* and *Total Measurement Range* parameters. (see below)

- A value of “0” disables scaling. The position and velocity data is reported at 16 bit resolution.
- A value of “1” enables scaling. The position and velocity data is reported in the engineering units set by the *Counts per Turn* and *Total Measurement Range* parameters.

NOTE  Velocity data is scaled by the *Measuring Units per Revolution* parameter if the parameter is enabled. The exception is when velocity data is reported in revolutions per minute (RPM).

NOTE  This parameter is forced into its disabled state when the Class 4 Functionality parameter is set to its disabled state. Therefore, if the Class 4 Functionality parameter is set to its disabled state, the Scaling Function Control, MUR, and TMR parameters are ignored and the NR60E2 reports position at its maximum resolution and number of turns.

Counts per Turn

This parameter is called *Measuring Units Per Span* in EtherNet/IP systems. This parameter is called *Code Sequence* in PROFINET systems. This parameter is used to scale the position and/or velocity data. This parameter is disabled when the *Scaling Function Control* parameter is set to its disabled state.

- Values can range from 2 to 65,536 counts per turn for single turn NR60E2 units.
- Values can range from 1 to 65,536 counts per turn for multi-turn NR60E2 units.

NOTE  Changing the Counts per Turn parameter clears the internal position offset. The current position reference will be lost. Changes to this parameter should be made before the position is preset.

The number of turns encoded by the NR60E2 is not controlled with this parameter. The *Total Measurement Range* parameter is used to control when the position data rolls over to zero, which controls the number of turns encoded by the NR60E2.

Total Measurement Range

The *Total Measurement Range* parameter sets the total number of counts before the position value returns to zero. It places an upper limit on the position value and the *Preset Value* parameter. This parameter is disabled when the *Scaling Function Control* parameter is set to its disabled state.

The *Total Measurement Range* parameter has the following ranges:

- **Single Turn NR60E2:** Range of 2 to 65,536
- **28 bit Multi-turn NR60E2:** Range of 2 to 268,435,456
- **30 bit Multi-turn NR60E2:** Range of 2 to 1,073,741,824

NOTE  Changing the *Total Measurement Range* parameter clears the internal position offset. The current position reference will be lost. Changes to this parameter should be made before the position is preset.

Note that the value of the *Counts Per Turn* parameter does not limit the range of values that can be programmed into the *Total Measurement Range* parameter. There is no fixed relationship between the *Total Measurement Range* and *Counts per Turn* parameters, which leads to interesting applications that use the two parameters.

Programmable Parameters (continued)

Total Measurement Range (continued)

Roll Over on Fractional Number of Turns

When the *Total Measurement Range* is less than the total counts available from the NR60E2, the position will return to zero before the full mechanical travel is completed.

- ▶ When the *Scaling Function Control* parameter disables the *Counts Per Turn* and *Total Measurement Range* parameters, the total counts available equals 65,536 multiplied by the number of turns the NR60E2 can encode.
- ▶ When the *Scaling Function Control* parameter enables the *Counts Per Turn* and *Total Measurement Range* parameters, the total counts available equals the value of the *Counts per Turn* parameter multiplied by the number of turns the NR60E2 can encode.

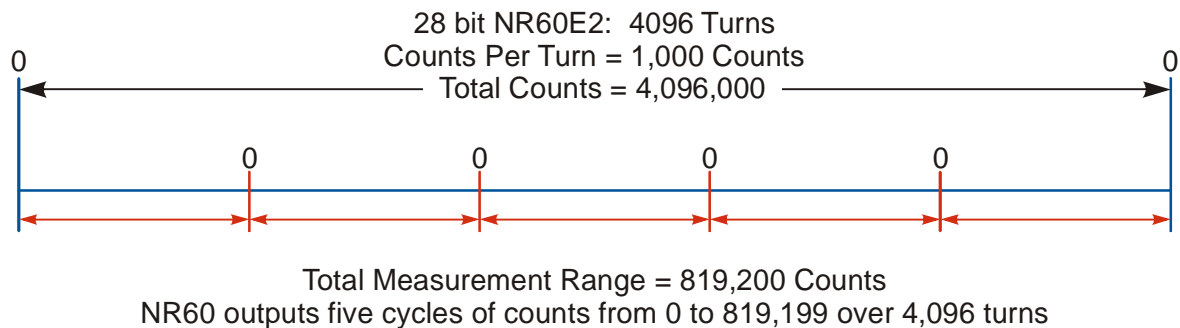

Figure R1.6 Fractional Turn Example 1

Figure R1.6 shows what occurs when the *Total Measurement Range* parameter is used to divide the total counts available from the NR60E2 into equal parts. In this case, a twenty-eight bit NR60E2 has its 4,096 turns evenly divided into five cycles of 819.2 turns.

NOTE ⚠ If the value of $\{\text{Total Counts} \div \text{Total Measurement Range}\}$ is an integer, the NR60E2 remains an absolute rotary sensor. You can remove power from the NR60E2, rotate it up to its maximum number of turns, re-apply power, and the NR60E2 will give you the correct position value. Figure R1.6 is an example of this setup because the division of the two parameters results in a quotient value of five.

*Programmable Parameters (continued)***Total Measurement Range (continued)***Roll Over on Fractional Number of Turns (continued)*

Figure R1.7 Fractional Turn Example 2

Figure R1.7 shows a single turn NR60E2 where the value of the *Total Measurement Range* parameter does not divide the full range of travel into equal parts. In this case, the position value will roll over to zero after 225 degrees of rotation. In this example the value of $\{\text{Total Counts Available} \div \text{Total Measurement Range}\}$ is a real number, 1.6, instead of an integer.

NOTE When the $\{\text{Total Counts Available} \div \text{Total Measurement Range}\}$ quotient is a real number, the NR60E2 will power up with the correct position value as long as the shaft is rotated less than half of the complete span of the encoder while power was removed. In practical terms:

- **For 30-bit NR60E2 multi-turn encoders:** If you remove power from the sensor and rotate the shaft less than 8,192 turns from the point where you removed power, the position reading will be correct when you re-apply power.
- **For 28-bit NR60E2 multi-turn encoders:** If you remove power from the sensor and rotate the shaft less than 2,048 turns from the point where you removed power, the position reading will be correct when you re-apply power.
- **For 16-bit NR60E2 single turn encoders:** If you remove power from the sensor and rotate the shaft less than 180 degrees from the point where you removed power, the position reading will be correct when you re-apply power.

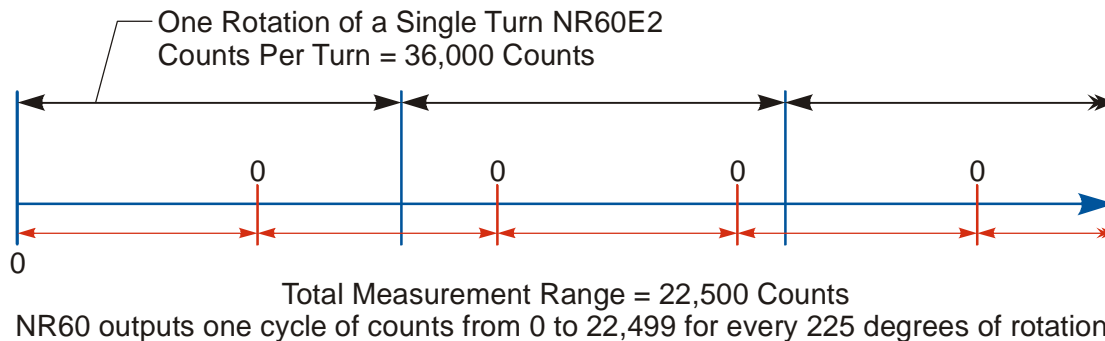
NOTE If the point that you re-apply power at is greater than the limits listed above, the position value from the NR60E2 will be off by at least ± 1 turn.

Encoding Additional Turns

When the *Scaling Function Control* parameter enables the *Counts Per Turn* and *Total Measurement Range* parameters, and the *Counts Per Turn* parameter is set to a value less than its maximum, the *Total Measurement Range* parameter can be used to require additional rotations of the shaft before the position value reaches the roll over count. For example, assume a single turn NR60E2 that has its *Counts Per Turn* parameter set to 360 and its *Total Measurement Range* parameter set to 64,800. With this setup, the shaft of the NR60E2 must rotate 180 turns, $\{64,800 \div 360\}$, before the position returns to zero. In this application, the single turn NR60E2 acts as a 180 turn encoder with one degree position resolution.

The same trade off between resolution and number of turns encoded can be made with the multi-turn NR60E2 encoders. For example, if a 30-bit NR60E2 encoder has its *Counts Per Turn* parameter set to 360 and its *Total Measurement Range* parameter set to its maximum of 1,073,741,824, the NR60E2 will encode 2,982,616.17 turns with one degree resolution.

In all of these applications, the NR60E2 has the same motion restrictions listed in the *Roll Over on Fractional Number of Turns* section above. Exceeding these limits will result in a position value error of at least ± 1 turn when power is re-applied.

Programmable Parameters (continued)

Velocity Format

The NR60E2 can transmit velocity data over the network in addition to position data. This parameter sets the units of measure for the velocity data. The formats available depends on the enabled protocol.

- EtherNet/IP and Modbus TCP: counts/second, counts/millisecond, counts/minute, RPM
- PROFINET: counts/second, counts/100 milliseconds, counts/10 milliseconds, RPM

NOTE  Except for RPM, velocity data is always scaled by the *Counts Per Turn* parameter.

Preset Value

This parameter allows you to preset the position to any value in its single or multi-turn range without rotating the shaft. This value is not stored in memory. This value must be included in every Preset Position command. The range of values depends on the state of the *Scaling Function Control* parameter and the value of the *Total Measurement Range* parameter.

- When the *Scaling Function Control* parameter is disabled, the Preset Value range is:
 - 0 to 65,535 for single turn NR60E2 encoders
 - 0 to 268,435,455 for 28 bit multi-turn NR60E2 encoders
 - 0 to 1,073,741,823 for 30 bit multi-turn NR60E2 encoders
- When the *Scaling Function Control* parameter is enabled:
 - 0 to (value of *Total Measurement Range* parameter) - 1

NOTE  The position reset switch on the back of the unit can be used to reset the Position Value to zero. The position will always go to zero. See the [Position Reset Switch](#) section on page 13 for the location of the switch.

Notes

CONFIGURING NETWORK INTERFACES

This section lists suggestions for configuring the network interfaces on your computer or laptop before attaching to the NR60E2.

Firewall Settings

Firewalls are hardware devices or software that prevent unwanted network connections from occurring. Firewall software is present in Windows XP and above and it may prevent your computer from communicating with the NR60E2. The internal webserver uses port 80, which is the default http port, and should work without changing any firewall settings. Configuring your firewall to allow communication with the NR60E2 is beyond the scope of this manual.

Disable All Unused Network Interfaces

Routing and default gateway setting on your computer might prevent connection to the NR60E2. Broadcast packets that are used to find the NR60E2 often go out the wrong port. The easiest way to avoid this problem is to temporarily disable all network interfaces that are not attached to the NR60E2.

This includes all wireless interfaces as well as all Bluetooth interfaces.

Configure Your Network Interface

Before you can communicate with the NR60E2, your network interface must be on the same subnet as the encoder.

NOTE  If you do not know the IP address the NR60E2 is presently using, set the Address Switches on the NR60E2 to '999' to set an address to 192.168.0.50. See [Use the NR60E2 IP Address Switches](#), starting on page 35 for information on setting the address switches.

NOTE  The rest of this procedure assumes you are using the 192.168.0.xxx subnet. If you are not, you will have to adjust the given network addresses accordingly.

The easiest way to check the current settings for your NIC is with the 'ipconfig' command.

- ▶ For Windows 7, click on the [Start] button, and type "cmd" in the "Search programs and files" text box. Press [Enter] on the keyboard.
- ▶ For Windows 8 and 10, press the [Win+X] keys and select "Command Prompt" from the resulting popup. There is no need to run the command prompt as the administrator, so do not select "Command Prompt (Admin)".

Configure Your Network Interface (continued)

A DOS like terminal will open. Type in 'ipconfig', press [Enter] on the keyboard and the computer will return the present Address, Subnet Mask, and Default Gateway for all of your network interfaces. If your present address is 192.168.0.xxx, where 'xxx' does not equal 50, and your subnet mask is 255.255.255.0, then you are ready to configure your NR60E2 encoder. Figure R2.1 shows the output of an ipconfig command that shows the "Local Area Connection 2" interface on the 192.168.0.xxx subnet.

```

C:\>ipconfig

Windows IP Configuration

Ethernet adapter Local Area Connection:

    Connection-specific DNS Suffix  . : 
    IP Address . . . . . : 176.16.25.17
    Subnet Mask . . . . . : 255.255.0.0
    Default Gateway . . . . . : 176.16.255.1
    DHCP Class ID . . . . . : 

Ethernet adapter Local Area Connection 2:

    Connection-specific DNS Suffix  . : 
    IP Address . . . . . : 192.168.0.224
    Subnet Mask . . . . . : 255.255.255.0
    Default Gateway . . . . . : 
  
```

Figure R2.1 ipconfig Command

If your present address is not in the 192.168.0.xxx range, type in 'ncpa.cpl' at the command prompt and hit [Enter] on the keyboard.

- For Windows 7, this open the *Network Connections* window. Double click on the appropriate interface. In the window that opens, select "Internet Protocol Version 4 (TCP/IP v4)" from the list and then click on the [Properties] button.
- For Windows 8 and 10, this open the Network Connections window. Double click on the appropriate interface. In the window that opens, select "Internet Protocol Version 4 (TCP/IP v4)" from the list and then click on the [Properties] button.

Set the address and subnet mask to appropriate values. (192.168.0.1 and 255.255.255.0 will work for an NR60E2 that has factory default settings.) The default gateway and DNS server settings can be ignored.

Test Your Network Interface

Going back to the terminal you opened in the last step, type in 'ping aaa.bbb.ccc.ddd' where 'aaa.bbb.ccc.ddd' in the IP address of the NR60E2. The computer will ping the unit and the message "Reply from aaa.bbb.ccc.ddd: bytes=32 time<10ms TTL=128" should appear four times.

If the message "Request timed out." or "Destination host unreachable" appears, then one of four things has occurred:

- You set a new IP address, but have not yet cycled power to the NR60E2
- You did not enter the correct address in the ping command.
- The IP address of the NR60E2 is not set correctly.
- The NR60E2 and the computer are not on the same subnet.

PHYSICAL INSTALLATION

This section is intended for the engineer or technician responsible for installing the NR60E2 networked resolver encoder. Information in this chapter includes installation guidelines, information about online CAD files, and mechanical drawings.

1.1 Installation Guidelines

1.1.1 Electrostatic Discharge Prevention

Electrostatic discharge can damage the NR60E2 if the discharge is into the power or ethernet connectors. Follow these guidelines when handling the unit.

- 1) Touch a grounded object to discharge static potential before handling the unit.
- 2) Work in a static-safe environment whenever possible.
- 3) Do not touch the pins of the network connectors or power connector.
- 4) Do not disassemble the unit

1.1.2 Suitable Environment

The NR60E2 has an IP67 environmental rating and can be installed in most industrial environments, including area subject to washdown spray and temporary immersion.

NOTE  The IP67 rating is contingent on the proper installation of the power and ethernet mating connectors as well as the threaded hole plug. The NR60E2 should not be operated in an industrial environment without these items installed.

1.1.3 Shaft Loading

A flexible coupler should be used when connecting an NR60E2 to a drive shaft, because any mismatch in shaft alignment will result in large radial or axial loading on the shaft of the encoder. Limit shaft loading to the following values. These values statistically yield an L10 life of 2×10^9 revolutions. (Statistically, only 10% of the bearings will have failed after 2×10^9 revolutions.) Shaft loading has an exponential effect on bearing life. The effect is actually cubic. Cutting a shaft load in half will result in an eight fold increase in bearing life.

| Radial Load | Axial Load |
|-----------------|----------------|
| 40 lbs. (178 N) | 20 lbs. (88 N) |

Table T1.1 NR60E2 Maximum Shaft Loading Specifications

1.1.4 A Note on Cable Direction

All of the dimensional drawings in the *Outline Drawings* section (1.3), show the direction that the cable exits when using right angle connectors. Use this information to properly route cables when designing the NR60E2 mounting.

1.2 Availability of CAD Drawings

CAD drawing for all NR60E2 devices are available on the AMCI website.

1.3 Outline Drawings

1.3.1 Servo Mount, End Connect, Aluminum or SS Body

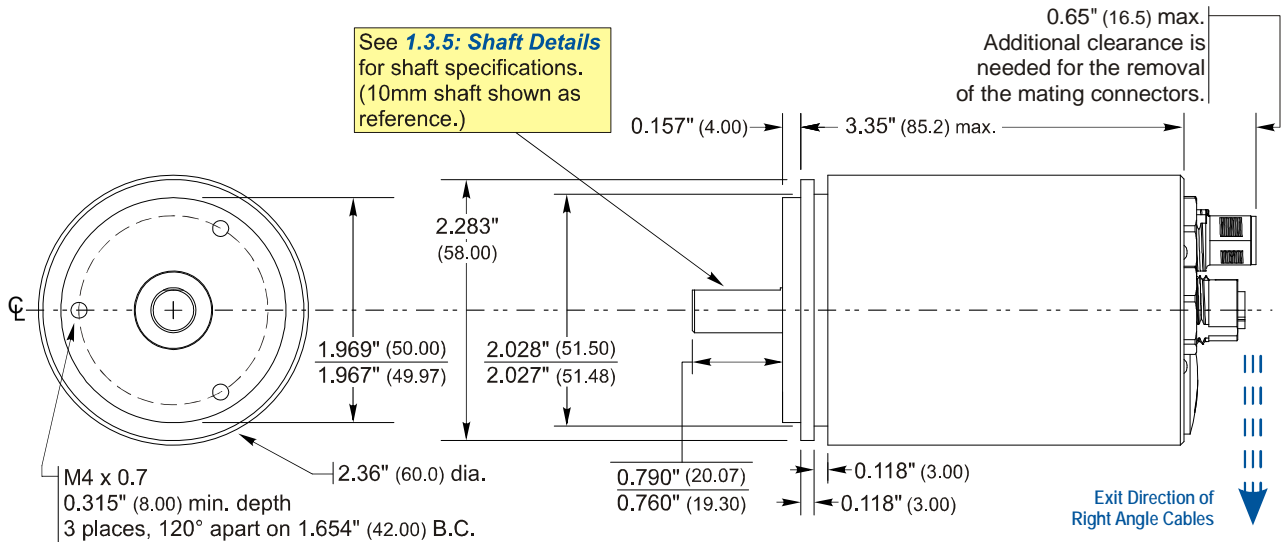

Figure T1.1 Servo Mount, Side Connector Outline Drawing

1.3.2 Servo Mount, Side Connect, Aluminum Body Only

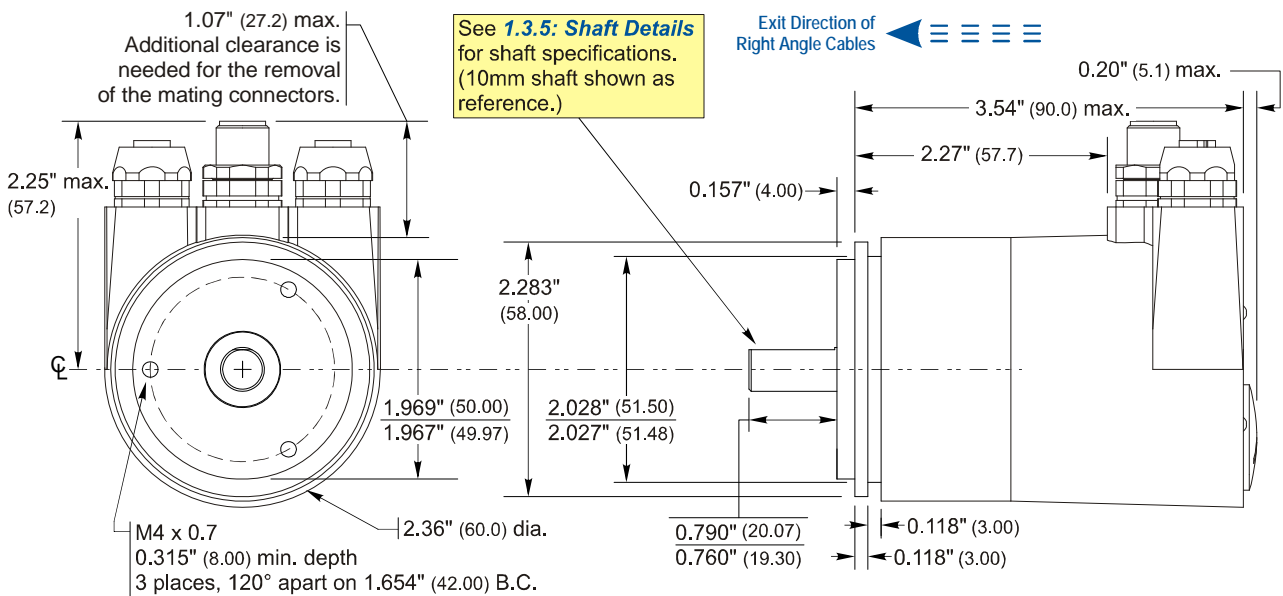

Figure T1.2 Servo Mount, Side Connector Outline Drawing

1.3 Outline Drawings (continued)

1.3.3 Flange Mount, End Connect, Aluminum or SS Body

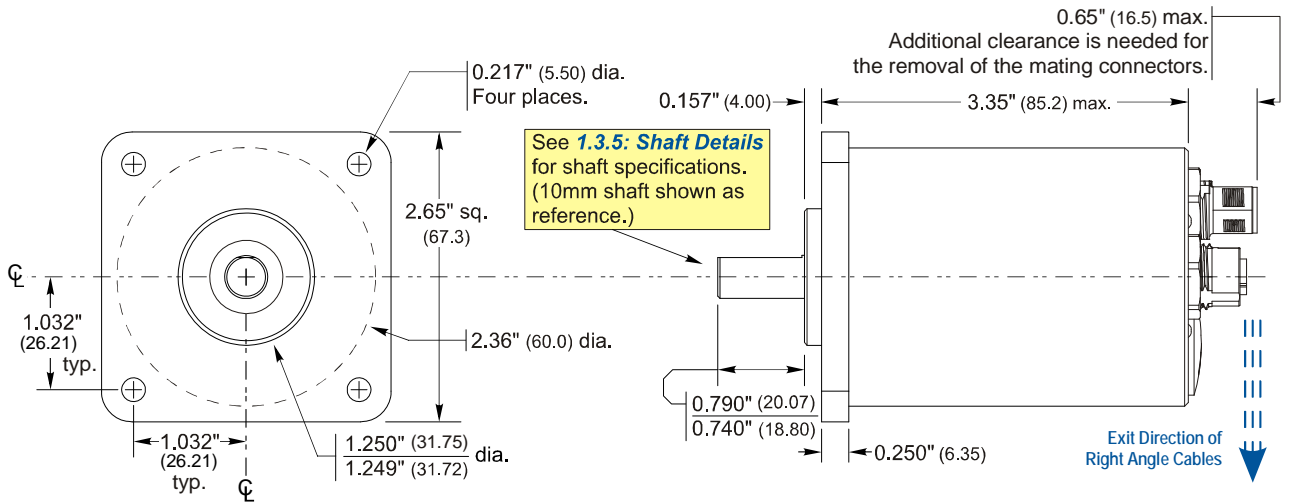

Figure T1.3 Flange Mount, Side Connector Outline Drawing

1.3.4 Flange Mount, Side Connect, Aluminum Body Only

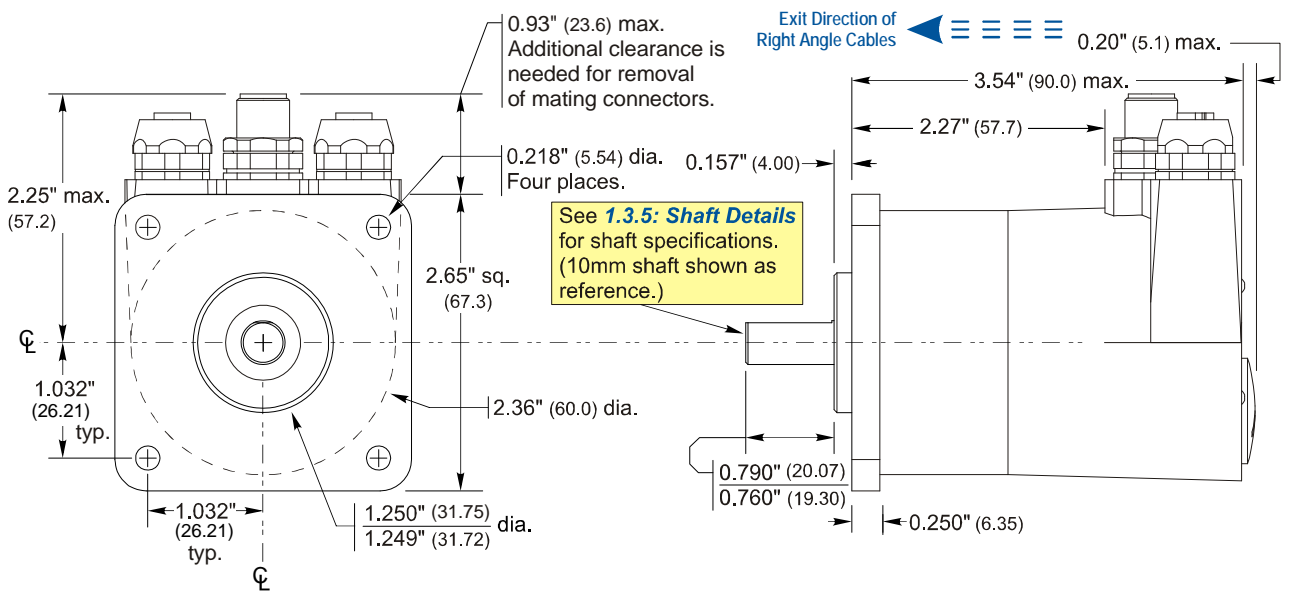
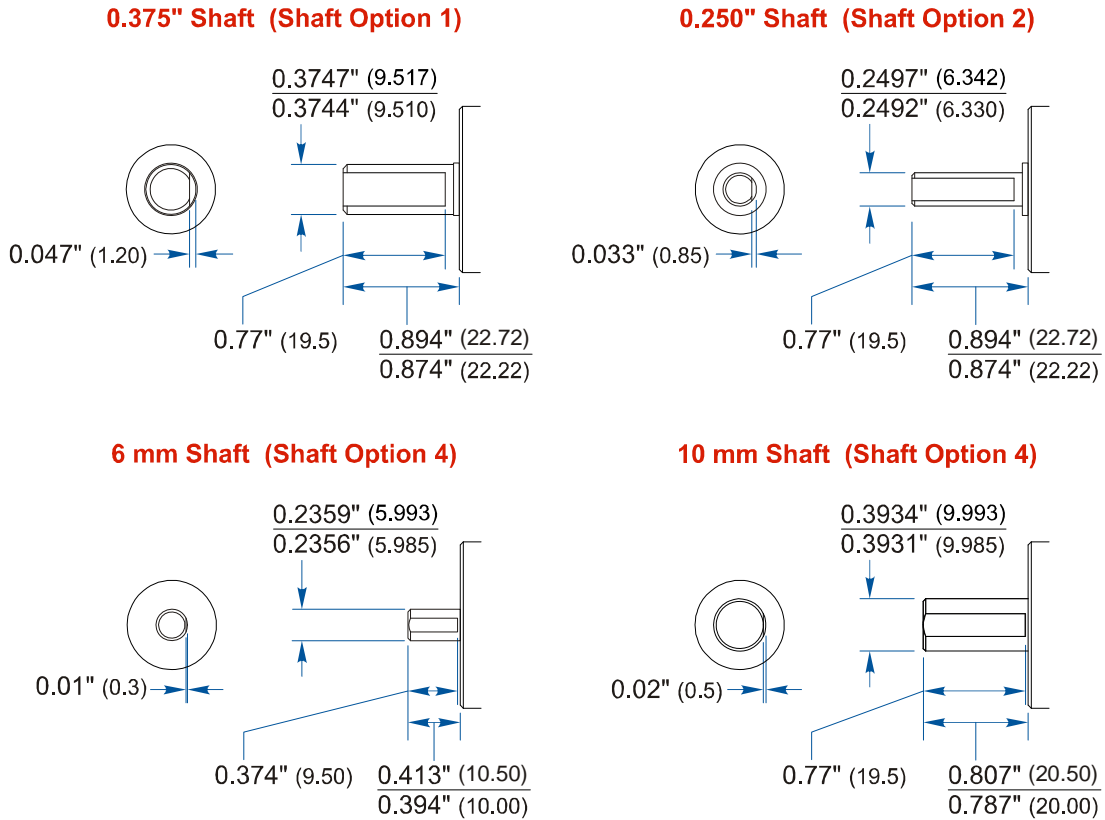

Figure T1.4 Flange Mount, Side Connector Outline Drawing

1.3 Outline Drawings (continued)

1.3.5 Servo and Flange Shaft Details

The figure below shows the pilot of a flange mount nose. Listed dimensions are identical for the servo mount option.



() = Dimensions in mm

Figure T1.5 Shaft Details

1.3 Outline Drawings (continued)

1.3.6 Hub Shaft Mount, End Connect, Aluminum or SS Body

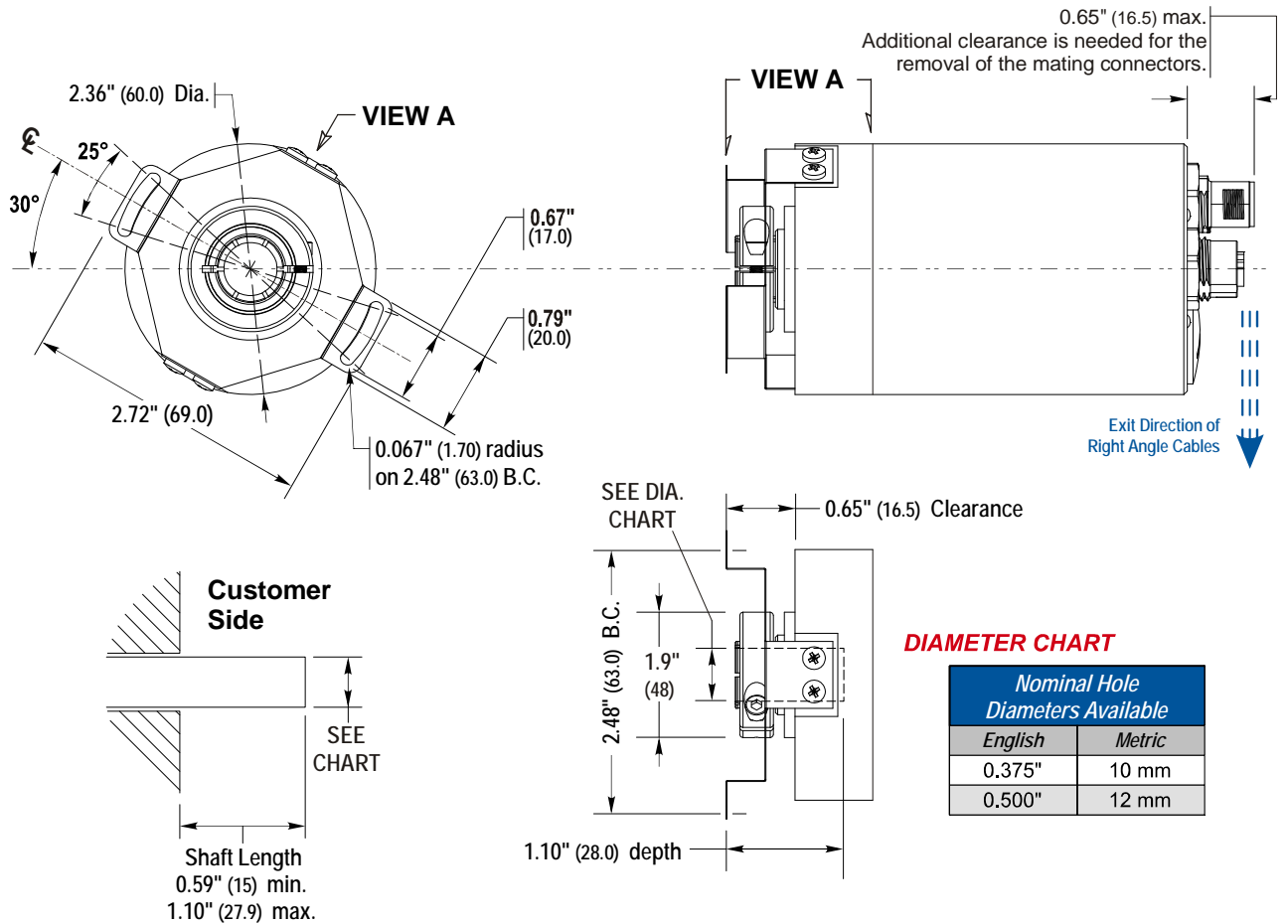

Figure T1.6 Hub Shaft Mount, Side Connector Outline Drawing

1.3 Outline Drawings (continued)

1.3.7 Hub Shaft Mount, Side Connect, Aluminum Body Only

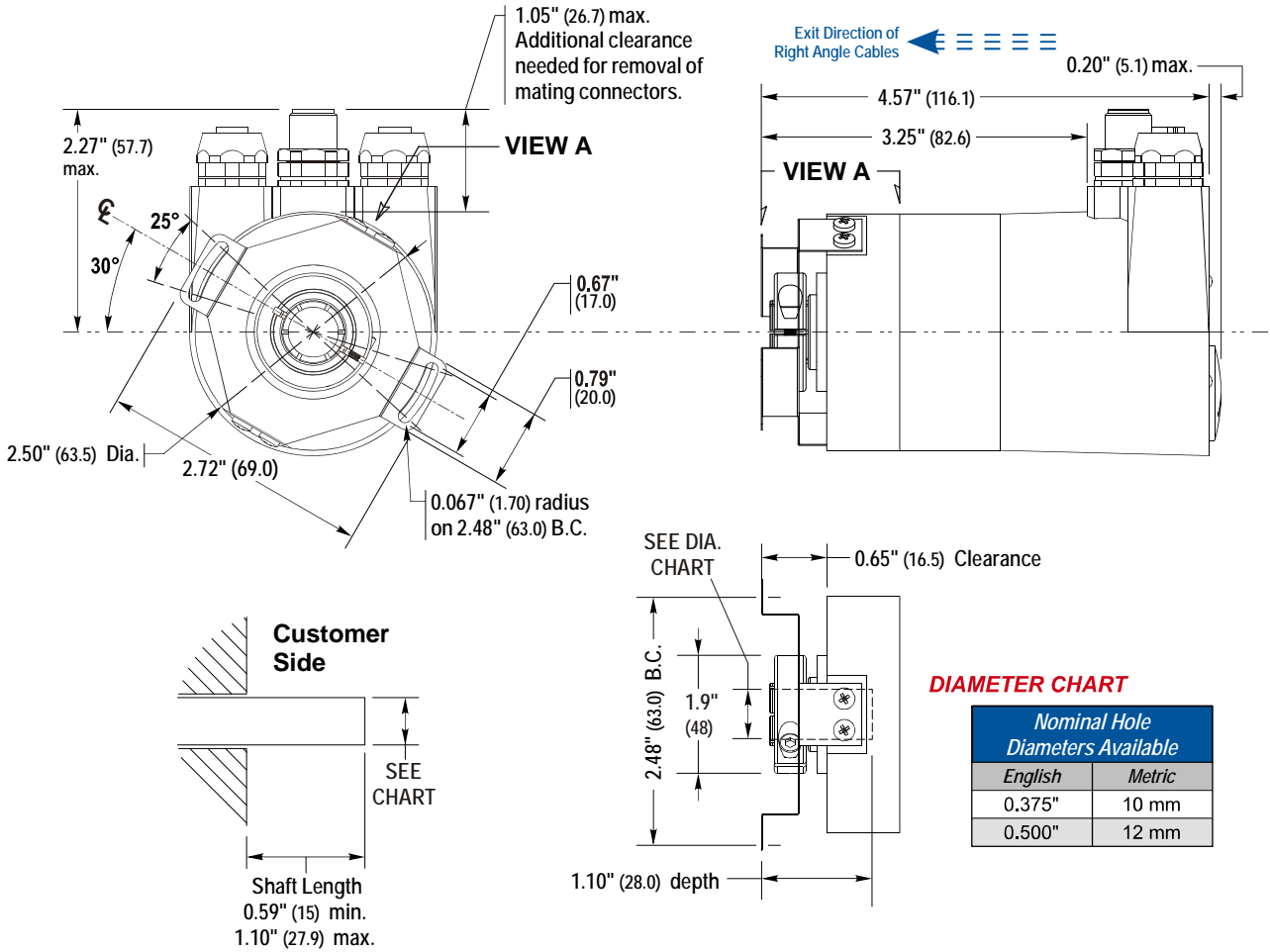

Figure T1.7 Servo Mount, Side Connector Outline Drawing

TASK 2

WIRE POWER AND ETHERNET

2.1 Power Wiring Installation

2.1.1 Power Wiring Guidelines

The NR60E2 requires a power supply of 12 to 48 Vdc, (11 to 54 Vdc as absolute maximums). Power requirement is 2.5W, or approximately 100 mA @ 24Vdc.

Because of the low power requirements, NR60E2 power wiring should not be run with high power AC or DC cabling.

2.1.2 Connector Location and Pinout

Figure T2.1 below shows the power connector location on end and side connect units as well as the connector pinout.

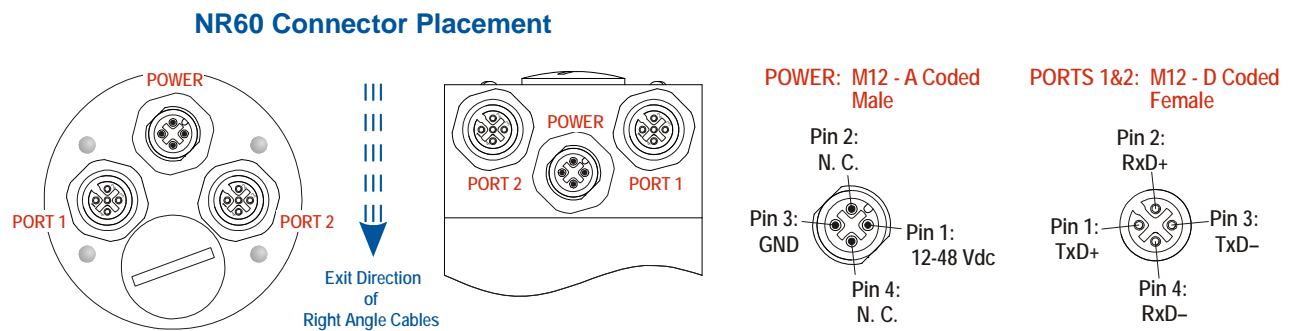

Figure T2.1 NR60E2 Connector Placement

2.1.3 Right Angle Cable Exit Direction

When designing a mounting solution for the NR60E2, be aware of the cable exit direction when using right angle mating connectors. Figure T2.1 above shows the direction of the cable when using AMCI, TURCK, or Phoenix Contact cordsets.

2.1.4 Mating Connectors and Cordsets

AMCI offers the following mating connector and cordsets that mate with the NR60E2 power connector. Note that the power connector will mate with any connector or cordset that follows the M12, 4 pin, A-coded standard.

| AMCI # | Description |
|---------|---|
| MS-29 | Mating connector for Power connector. Screw terminal connections. 6 to 8 mm dia. cable. 18 AWG max. Straight, IP67 rated when properly installed. |
| CNVL-2M | Molded cordset for Power connector. 22 AWG wire, 2 meters in length. Straight connector to flying leads. IP67 rated when properly installed. |

Table T2.1 Compatible Connectors and Cordsets

2.1 Power Wiring Installation (continued)

2.1.5 CNVL-2M Cable Specifications

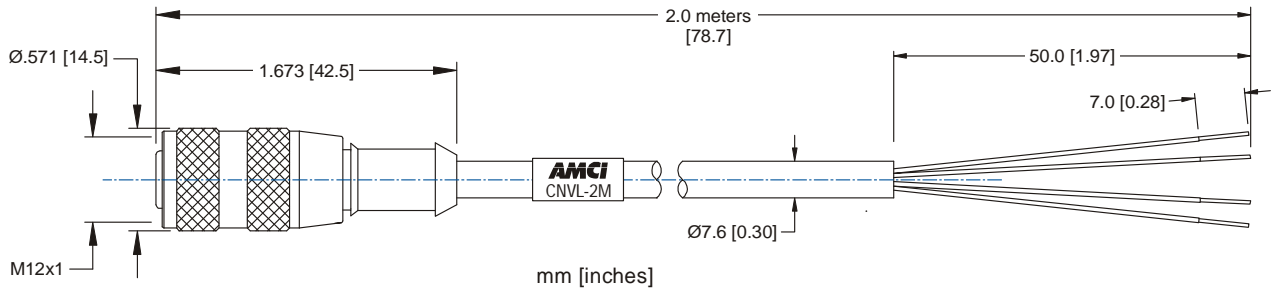

Female End View

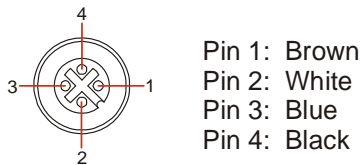

Figure T2.2 CNVL-2M Cable Outline and Pinout

| Specifications | |
|---------------------------------|----------------|
| Contact Material /Plating | Brass / Gold |
| Coupling Nut Material / Plating | Brass / Nickel |
| Outer Jacket material / Color | PVC / Gray |
| Conductor Insulation Material | PVC |
| Number of Conductors / Gauge | 4 / 22 AWG |

| Specifications | |
|-----------------------|--------------------------------------|
| Rated Current (amps) | 4 A |
| Rated Voltage (volts) | 250 V |
| Temperature Range | -40°C to +105°C (-40°F to +221°F) |
| Protection Class | NEMA 1, 3, 4, 6P IEC IP68, IP69K |

Table T2.2 CNVL-2M Cable Materials and Ratings

2.2 Ethernet Wiring Installation

2.2.1 Signal Wiring Guidelines

- Ethernet signals are low voltage, low power, digital signals. Ethernet cables should not be run with high power AC or DC cabling.
- Ethernet cable can be run in conduits with other low power AC and DC signal cables. Ideally, cables will be run in metal conduit that is bonded along its entire length.
- Ethernet cable should not be run in parallel with high power AC or DC cabling to minimize capacitive coupling of electrical noise. If they must be run in parallel, separate them as much as possible.
- If an Ethernet cable must cross high power AC or DC cabling, it should do so at a right angle to minimize inductive coupling of electrical noise.
- Cable length must be limited to 100 meters (328 ft), between devices to comply with 802.3 Ethernet standards.

2.2 Ethernet Wiring Installation (continued)

2.2.2 Connector Location and Pinout

Figure T2.1, in section 2.1.2 above, shows the location of the two ethernet ports on end and side connect units as well as the connector pinout. The NR60E2 integrates a network switch between the two ports. When installing the NR60E2 in a ring topology, it is important to document system connections for both ports. Ethernet/IP uses ring topology in DLR installations. PROFINET uses ring topology in MRP installations.

2.2.3 Right Angle Cable Exit Direction

When designing a mounting solution for the NR60E2, be aware of the cable exit direction when using right angle mating connectors. Figure T2.1 above shows the direction of the cable when using AMCI, TURCK, or Phoenix Contact cordsets.

2.2.4 TIA/EIA-568 Color Codes

There are two color codes in common use when wiring Ethernet connections with twisted pairs. Either one of these standards is acceptable. Note that accidentally reversing the Tx/Rx pairs will not affect the operation of the NR60E2. The NR60E2 has an “auto-sense” port that will automatically adjust for swapped pairs.

| Signal | 568A Color | 568B Color |
|-----------------|---------------------|---------------------|
| +Transmit (+Tx) | White/Green Tracer | White/Orange tracer |
| –Transmit (–Tx) | Solid Green | Solid Orange |
| +Receive (+Rx) | White/Orange Tracer | White/Green Tracer |
| –Receive (–Rx) | Solid Orange | Solid Green |

Table T2.3 TIA/EIA Color Codes

2.2.5 Mating Connectors and Cordsets

AMCI offers the following mating connector and cordsets that mate with the NR60E2 Ethernet port connectors.

| AMCI # | Description |
|---------|---|
| MS-28 | Mating connector for Ethernet port connector. Screw terminal connections. 6 to 8 mm dia. cable. Straight, IP67 rated when properly installed. |
| CNER-5M | Molded cordset for Ethernet connector. 5 meters in length. Straight M12 4 pin D-coded to RJ-45 connector. IP67 rated when properly installed. |

Table T2.4 Compatible Connectors

2.2 Ethernet Wiring Installation (continued)

2.2.6 Sample Wiring Diagram

The diagram below shows how to wire a network cable to an MS-28.

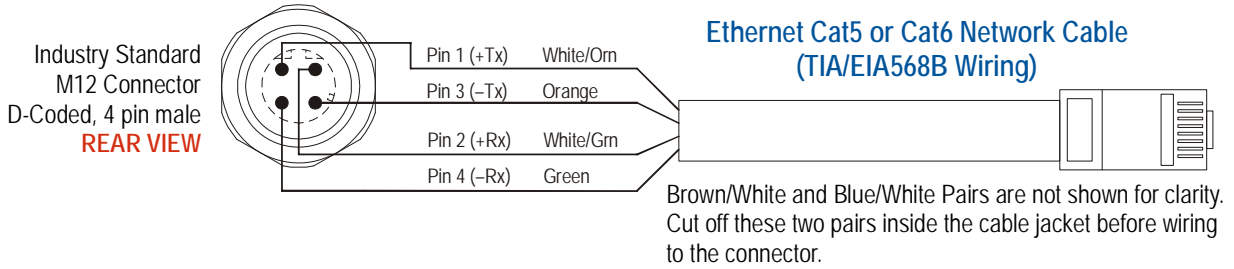

Figure T2.3 MS-28 Sample Wiring

NOTE

Figure T2.3 above shows the proper wiring for a cable that is terminated on the RJ45 connector to the TIA/EIA568B standard. The only difference between the 568A and 568B standards is that the two pairs are swapped. With the “auto-switch” port that is built into the NR60E2, the system will work correctly, regardless of which standard was used to terminate the RJ45 plug.

TASK 3

SET THE IP ADDRESS AND PROTOCOL

This section is intended for the engineer or technician responsible for setting the IP address and network protocol of an AMCI NR60E2. The factory default IP address is 192.168.0.50. The factory default protocol is EtherNet/IP.

3.1 General Guidelines

Each NR60E2 has a built-in web server that can be used to set the IP address and network protocol. The IP address can also be set with rotary switches on the back of the device.



The factory default protocol is EtherNet/IP. If you need to switch protocols, you must use the internal web server.

- ▶ With the EtherNet/IP and Modbus TCP protocols, the IP address is used by the device for protocol communications and the internal webserver. With the PROFINET protocol, the IP address is only used for the internal webserver. The IP address used by a PROFINET device for protocol communications is set by the bus master when the device connects to the PROFINET network.
- ▶ There is a MAC address label on each NR60E2 which has a writable surface. There is room on the label for writing the programmed IP address of the unit. It is a best practice to use this label to document the IP address of the unit in case it is ever repurposed.

3.1.1 Web Server Guidelines

- ▶ The web server interface allows you to set the protocol, IP address, network mask, and default gateway to any value.
- ▶ You must know the IP address of the NR60E2 before you can connect to its web server. The IP address of the webserver can be set to 192.168.0.50 by setting the rotary switches to a value of “999”.

3.1.2 Rotary Switch Guidelines

- ▶ Setting the switches to “000” enables the internal DHCP client. If enabled, a DHCP server must be available on every power up to transmit the IP address to the NR60E2. The address sent to the NR60E2 by the DHCP server is not stored by the NR60. If you later set the switches in the range of “255” to “989”, the last address stored will be used, not the DHCP address.
- ▶ Setting the switches in the range of “001” to “254” sets the last octet of the IP address. The subnet is taken from the last address stored in flash memory.
- ▶ Setting the switches in the range of “255” to “989” forces the NR60E2 to use the last IP address stored in flash memory.
- ▶ Switch settings in the range of “990” to “998” should not be used. These switch settings are used during factory tests.
- ▶ Setting the switches to “999” sets the IP address to 192.168.0.50. This setting allows you to set the IP address to a known setting if the IP address is ever lost. A new IP address can be set from the internal web server or the NET Configurator utility while the switches are set to “999”. The programmed address will be used once the switches are set in the range of “255” to “989”.

3.2 Determine the Best Method for Setting the IP Address

There are three methods for setting the IP address on an NR60E2. Table T3.1 below outlines the available methods and when you can use them.

| Method | Restrictions | Section |
|--|---|---------|
| <i>Use Factory Default Settings</i> | 1) The machine must use 192.168.0.xxx subnet. 2) The 192.168.0.50 address must be available. | 3.3a |
| <i>Use the NR60E2 IP Address Switches</i> | 1) If the NR60E2 is new from the factory, the machine must use 192.168.0.xxx subnet. 2) If the IP address of the NR60E2 was previously programmed, the machine must use the last subnet programmed into the NR60E2. | 3.3b |
| <i>Use the Embedded Web Server</i> | Available on units that support all three protocols. No restrictions on use. This is the preferred method. The internal webserver can be used to set the NR60E2 to any IPv4 address. The IP address and protocol will be stored in nonvolatile memory and used on subsequent power-ups. | 3.3c |
| <i>Use the AMCI NET Configurator Utility</i> | This method should only be used with units that do not have an embedded web server. (Those released prior to September, 2019.) This method can be used to set the NR60E2 to any IPv4 address and any protocol. The IP address and protocol will be stored in nonvolatile memory and used on subsequent power-ups. | 3.3d |

Table T3.1 Methods for Setting the IP Address

NOTE  There is a MAC address label on each NR60E2 which has a writable surface. There is room on the label for writing the programmed IP address of the unit. It is a best practice to use this label to document the IP address of the unit in case it is ever repurposed.

NOTE  In order to conform to the ODVA specification for EtherNet/IP, the NR60E2 also supports the DHCP protocol. You will need an EtherNet/IP DHCP server, such as the one available from Rockwell Automation, in order to program the IP address. The AMCI Net Configurator utility, or the embedded web server, offers the same functionality and should be used unless your company policy prevents you from installing third party utilities.

3.3a Use Factory Default Settings

The factory default address for the NR60E2 is 192.168.0.50 with a subnet mask of 255.255.255.0. The easiest way to verify this address is with the ping command as described in the *Configuring Network Interfaces* reference, which starts on page 21.

If the NR60E2 does not respond to this address, then check the label on the NR60E2 that lists the MAC address of the device. There is space on the label for noting the IP address of the device if it is changed. If the address was not documented, the best course of action is to use the IP address switches. Setting the switches to '999' forces the IP address to 192.168.0.50. See the following section, *Use the NR60E2 IP Address Switches*, to set the switches to '999'. Once the address is forced, the internal webserver can be used to set the address to any desired value.

3.3b Use the NR60E2 IP Address Switches

This method only sets the lower octet of the IP address. You have to use the web browser interface if you wish to change the network's subnet address. As an example, this method can configure an NR60E2 with factory default settings for any IP address in the 192.168.0.xxx subnet.

3.3b.1 Remove Power

Power should be removed from the NR60E2 before the IP Address switches are changed.

3.3b.2 Remove the Rear Hole Plug

Using figure T3.1 below as a reference, remove the rear hole plug to expose the IP Address switches. Place the plug in a clean environment. Dirt or oil on the threads or o-ring may prevent the plug from sealing properly when it is re-installed.

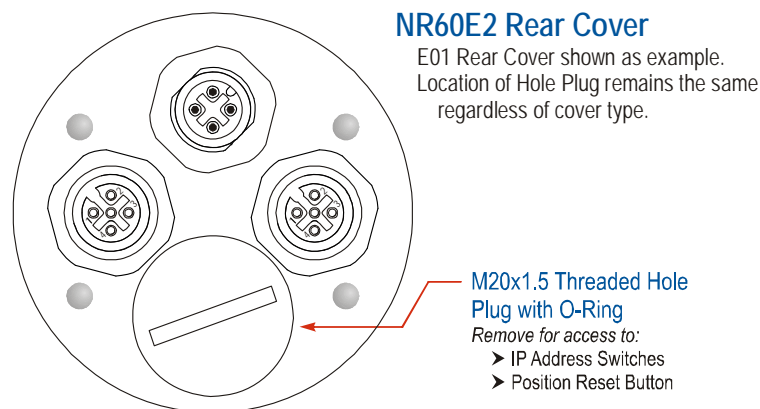

Figure T3.1 Rear Hole Plug Location

3.3b.3 Set the IP Address Switches

Figure T3.2 below shows the location of the IP Address Switches. A small flat head screwdriver can be used to set an address between 001 and 254. If the address is set to 000, DHCP will be enabled. If set to a value between 255 and 989, the NR60E2 will use the IP Address stored in its nonvolatile memory.

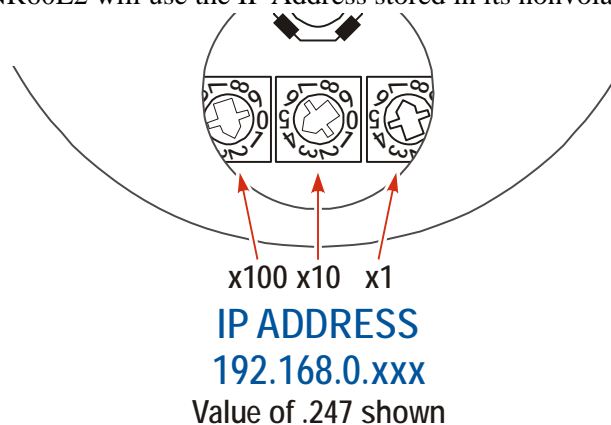

Figure T3.2 Default Setting for IP Address Switches

3.3b.4 Replace The Rear Hole Plug

Replace the Rear Hole Plug removed in step 3.3b.2. The plug should be tightened securely, but not over tightened, as damage the o-ring may result.

3.3c Use the Embedded Web Server

This method allows you to change the IP Address, Subnet Mask, and Default Gateway values. This method is available on all NR60E2 units sold in or after September, 2019. The unit's serial number can be used to determine the date of manufacture. The first four digits of the serial number are the month and year of manufacture. If the NR60E2 was manufactured prior to September, 2019, the AMCI NET Configurator software can be used to set the IP Address.

PREREQUISITE: You must know the present IP address of the NR60E2. The factory default address is 192.168.0.50. If you do not know the address, use the information in section 3.3b, *Use the NR60E2 IP Address Switches*, to set the Address Switches to '999'. This section starts on page 35. This sets the IP Address to 192.168.0.50 regardless of the data stored in flash memory.



These instructions assume that the Address Switches are set to "999". If they are instead set in the range of "001" to "254", the last octet of the IP address is set by the Address Switches. With these settings, the subnet can be changed, but the last octet of the programmed address must match the switch settings.

PREREQUISITE: Task 2.1: *Power Wiring Installation*, found on page 29. You must be able to power the NR60E2.

PREREQUISITE: Task: 2.2: *Ethernet Wiring Installation*, found on page 30. You must attach your NR60E2 to your computer.

PREREQUISITE: The network interfaces on your computer must be on the same subnet before you can communicate with an NR60E2. Refer to *Configuring Network Interfaces*, which starts on page 21, for additional information

3.3c.1 Disconnect the NR60E2 from the host controller and cycle power to the NR60E2.

This ensures that the unit does not have any open connections to the host controller.

3.3c Use the Embedded Web Server (continued)

3.3c.2 Start your web browser and connect to the NR60E2

The internal HTML pages should work with any browser. Once your web browser is running, enter the present IP address of the NR60E2 into the address bar. The default address is 192.168.0.50. The unit will respond with the following page.

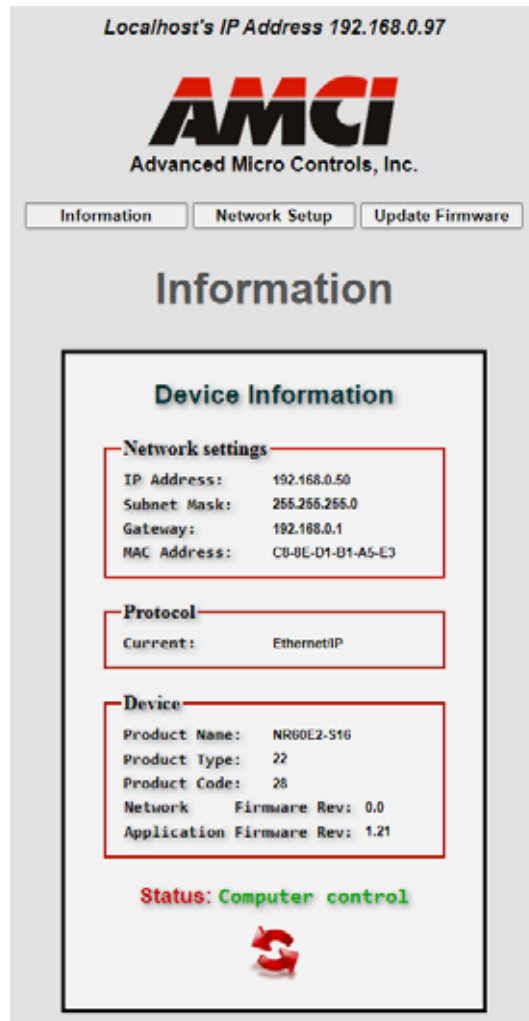

Figure T3.3 NR60E2 Information Webpage

3.3c Use the Embedded Web Server (continued)

3.3c.3 Network Setup Page

- 1) Click on the [Network Setup] button to switch to the Network Setup page shown below. This page shows the current IP address settings, as well as the configured protocol.

Figure T3.4 NR60E2 Network Setup Web Page

- 2) Enter your desired values into the IP Address, Subnet Mask, and Default Gateway fields.

NOTE ⚠ The Default Gateway setting is not optional! It must be set to a valid address on the chosen subnet. Because the Default Gateway is often not used in device level networks, if you do not have a required value for it, AMCI suggests setting the Default Gateway to the IP address of your host controller.

NOTE ⚠ If the address switches are set to any number between 1 and 254, the network subnet section of the address can be changed, but the lower octet of the address must be the address switches.

- 3) If need be, click on the proper radio button to select the required protocol.
- 4) Click on the [Write Configuration] button to write the new configuration to the unit. If there are any errors with the data, the unit will display a warning message instead of accepting the new values.

3.3c Use the Embedded Web Server (continued)

3.3c.3 Network Setup Page (continued)

5) If the values are accepted, the following pages will be displayed while the data is being written to the unit.

NOTE ⚠ Wait for the pop up window to appear before cycling power to the NR60E2. Cycling power before this window appears may corrupt the non-volatile memory of the NR60E2. The NR60E2 will also flash the Network Status LED red to indicate that power must be cycled.

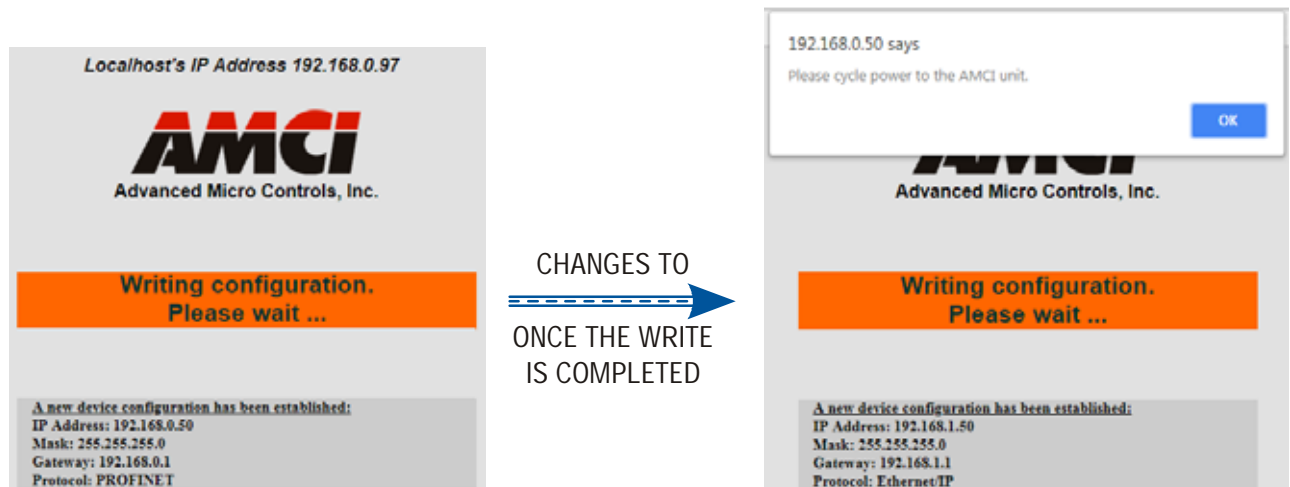

Figure T3.5 Write Configuration to Flash Memory Pages

6) Once instructed to do so, cycle power to the unit. You can now enter the new IP address into the address bar of your web browser to reconnect with the NR60E2. Note that if you changed the subnet that the NR60E2 is on, you may have to change the IP address of your computer's network port.

3.3d Use the AMCI NET Configurator Utility

This method allows you to change the IP Address, Subnet Mask, and Default Gateway values. If the NR60E2 was sold in or after September, 2019 the embedded web server should be used to set the IP Address instead of this method. The unit's serial number can be used to determine the date of manufacture. The first four digits of the serial number are the month and year of manufacture.

PREREQUISITE: You must know the present IP address of the NR60E2. The factory default address is 192.168.0.50. If you do not know the address, use the information in section 3.3b, [Use the NR60E2 IP Address Switches](#), to set the Address Switches to '999'. This section starts on page 35. This sets the IP Address to 192.168.0.50 regardless of the data stored in flash memory.

NOTE ⚠ These instructions assume that the Address Switches are set to "999". If they are instead set in the range of "001" to "254", the last octet of the IP address is set by the Address Switches. With these settings, the subnet can be changed, but the last octet of the programmed address must match the switch settings.

PREREQUISITE: Task 2.1: [Power Wiring Installation](#) found on page 29. You must be able to power the NR60E2.

PREREQUISITE: Task: 2.2: [Ethernet Wiring Installation](#), found on page 30. You must attach your NR60E2 to your computer.

PREREQUISITE: The network interfaces on your computer must be on the same subnet before you can communicate with an NR60E2. Refer to [Configuring Network Interfaces](#), which starts on page 21, for additional information

3.3d Use the AMCI NET Configurator Utility (continued)

3.3d.1 Download the AMCI Net Configurator Utility

The AMCI Net Configurator utility is available on our website, www.amci.com. It can be found in our *Support* section under *Software*. The program exists as a ZIP file.

3.3d.2 Install the AMCI Net Configurator Utility

Once downloaded, simply extract the program from the ZIP file and run the program to install the AMCI Net Configurator utility on your computer. The software installs as most products do, giving you the option to change the file locations before installing the utility. Once the install is complete, a link to the utility is available on the Start Menu. Note that the install process only copies the utility to the designated location and creates links to the Start Menu. No changes are made to registry settings.

3.3d.3 Verify that Your Host Controller is Disconnected from the NR60E2

The NET Configurator Utility uses EtherNet/IP to communicate with the NR60E2. EtherNet/IP is not a multi-master protocol. There can be only one bus master on the network at a time. In order to program the NR60E2, the AMCI NET Configurator utility must act as a bus master. Therefore, physically disconnect your host controller from the NR60E2 before starting the NET Configurator utility.

3.3d.4 Apply or Cycle Power to the NR60E2

Cycling power to the NR60E2 will reset any connections it may have with the host controller.

3.3d.5 Start the AMCI NET Configurator Utility

Double click on the utility's icon. A welcome screen similar to the one in figure T3.6 below will appear.

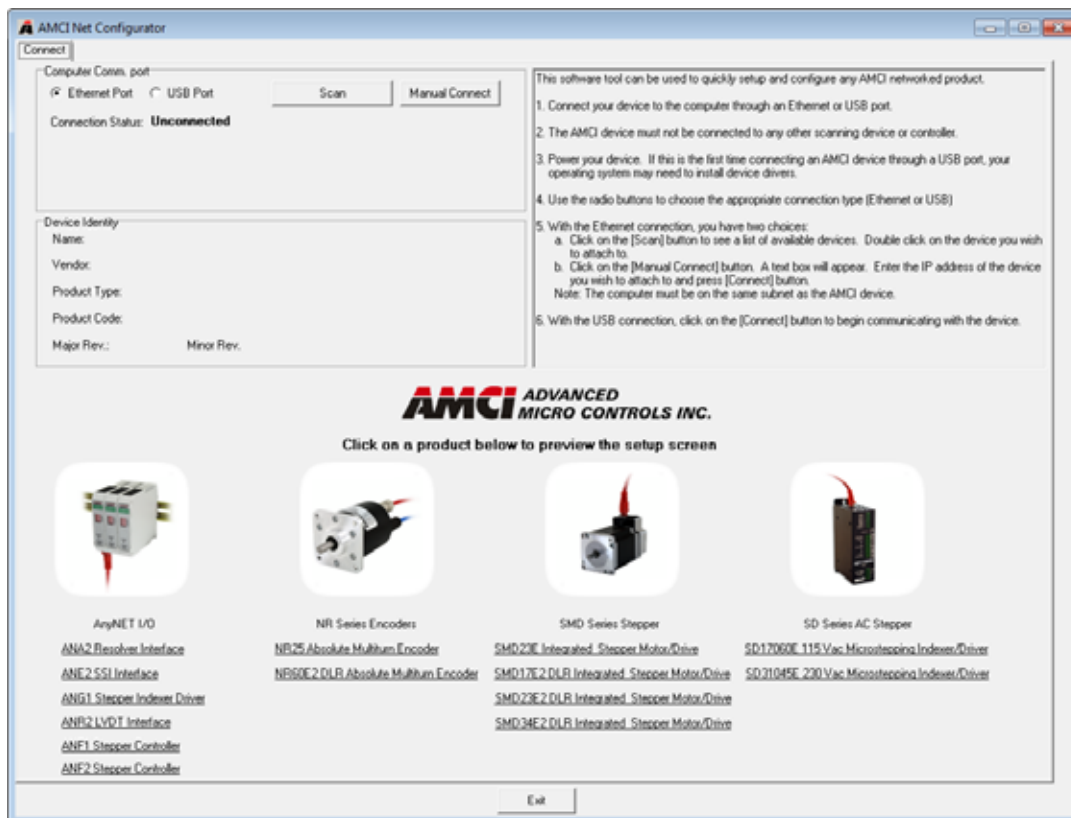

Figure T3.6 NET Configurator Welcome Screen

3.3d Use the AMCI NET Configurator Utility (continued)

3.3d.6 Press the [SCAN] button and Connect to the NR60

Pressing the [SCAN] button will open the window shown in figure T3.7. The NR60E2 will appear in the scan list only if the encoder and your network interface are on the same subnet.

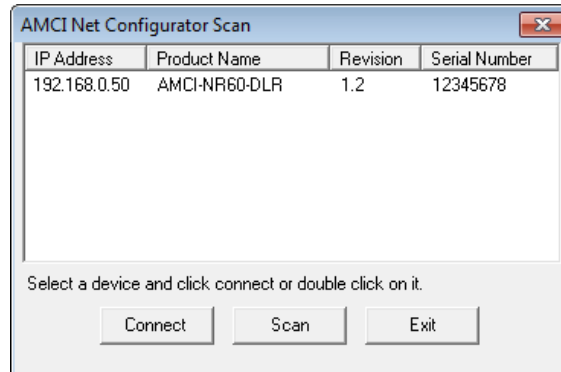

Figure T3.7 Scan for NR60

Click on the IP Address of the NR60E2 and click on the [Connect] button. The NET Configurator utility will connect to the encoder.

3.3d.7 Click on the "Allow IP..." Checkbox to Access the IP Settings

Figure T3.8 below shows the screen that results when you are connected to the NR60E2. In order to change the IP Address of the encoder, you must first click on the checkbox next to the text "Allow IP configuration changes. You will need to restart the device." Once the checkbox is selected, the [Set IP Address] button will be enabled.

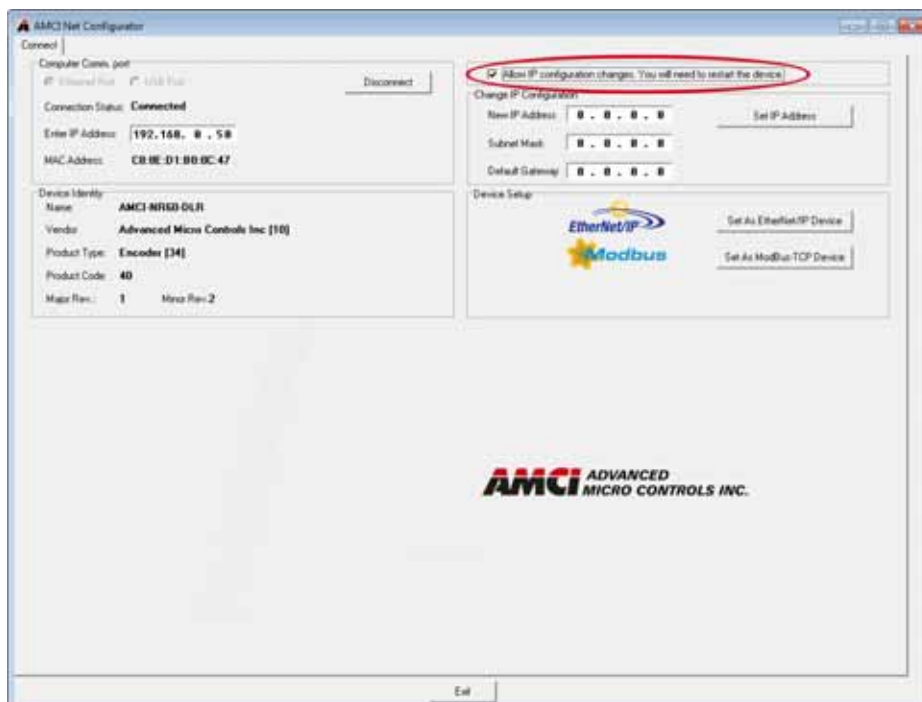



Figure T3.8 Enable IP Address Changes

3.3d Use the AMCI NET Configurator Utility (continued)

3.3d.8 Set the IP Address, Subnet Mask, and Default Gateway

Enter your desired values into the IP Address, Subnet Mask, and Default Gateway fields.

NOTE  The Default Gateway setting is not optional! In order to comply with the ODVA specification, it must be set to a valid address on the chosen subnet. Because the Default Gateway is often not used in device level networks, if you do not have a required value for it, AMCI suggests setting the Default Gateway to the IP address of your host controller.

NOTE  If the IP Address Switches are set to any value within the range of 1 to 254, the last octet of the IP address you program into the NET Configurator must match this value.

3.3d.9 Write the New IP Address to the NR60

Click on the [Set IP Address] button. If there is an error in the settings, the utility will tell you what is wrong. Once there are all correct, the utility will write the new IP address settings to the NR60E2. These settings are automatically saved to nonvolatile memory.

3.3d.10 Remove Power from the NR60

The new IP address will not be used until power to the NR60E2 has been cycled.

3.3d.11 Verify and Change the IP Address Switch Settings

If the IP Address Switches are set to any valid number between 1 and 254, the NR60E2 will use this number for the last octet of the IP address on power up. For example:

- You use the NET Configurator utility to program an address of 172.16.0.219.
- The IP Address Switches are left at their factory default setting of 050.

The NR60E2 will power up with an address of 172.16.0.**50**, not 172.16.0.**219**.

Therefore, if needed, follow the [Use the NR60E2 IP Address Switches](#) procedure to set the IP Address Switches to any value between 255 and 989. This procedure starts on page 35.

NOTE  Do not set the IP Address Switches to a value of 000, as this will enable the DHCP client on the NR60E2. If the DHCP client is enabled and a DHCP server is not available, the NR60E2 will never receive an IP Address.

NOTE  Address 990 through 999 are used by the factory when testing the unit. The IP Address Switches should not be set within this range by customers in the field.

PROTOCOL SPECIFIC INFORMATION

Manual Sections

The remainder of this manual is divided into three sections, one for each supported protocol. Each section has the protocol name in the page header.

Starting Pages

EtherNet/IP protocol: Page 45

Modbus TCP protocol: Page 71

PROFINET protocol: Page 75

Notes

IMPLICIT COMMUNICATIONS WITH AN EDS

Many EtherNet/IP platforms support the use of EDS files to simplify the addition and configuration of devices. This chapter covers the installation and use of the EDS file for systems that are programmed with Rockwell Automation Studio 5000 version 20 and above. Other systems will follow a similar pattern. Consult your controller's documentation if you need additional information.

Note: Use of an EDS file is completely optional. The NR60E2 can always be added to a system as a generic module. If you are using RSLogix 5000 version 19 and below, or RSLogix 500, adding the unit as a generic device is the only option available.

Using the EDS file simplifies configuration by adding named configuration tags and sizing the configuration values appropriately.

4.1 Obtain the EDS file

All AMCI EDS files are located on our website at the following address:

➤ <http://www.amci.com/industrial-automation-support/configuration-files/>

Products are listed in alphabetical order. Simply download the ZIP file and extract it to its own directory. The ZIP file contains the EDS text file and a custom icon file for the device.

4.2 Install the EDS file

4.2.1 Start the EDS Hardware Installation Tool

1) Once Studio 5000 is running, in the menu bar select Tools → EDS Hardware Installation Tool. This will open the EDS Wizard.



Figure T4.1 Opening the EDS Wizard

2) Click on [Next >] to advance to the Options screen.

4.2 Install the EDS file (continued)

4.2.2 Install the EDS File

1) On the Options screen, select the Register an EDS file(s) radio button and press [Next >].

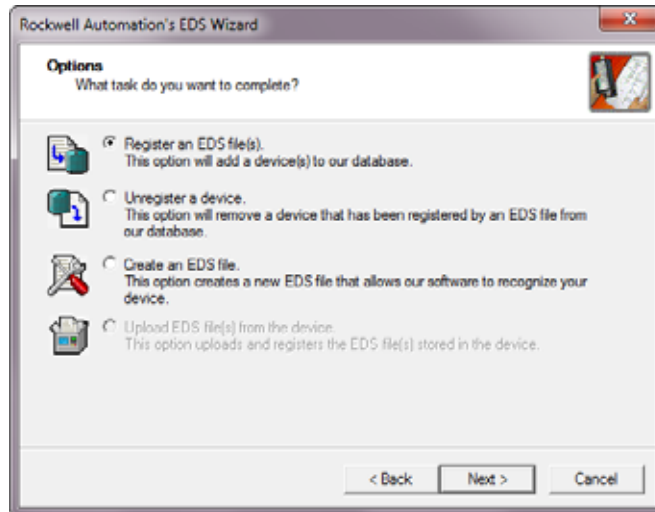

Figure T4.2 EDS Options Screen

2) The registration screen will open. Select the Register a single file radio button.

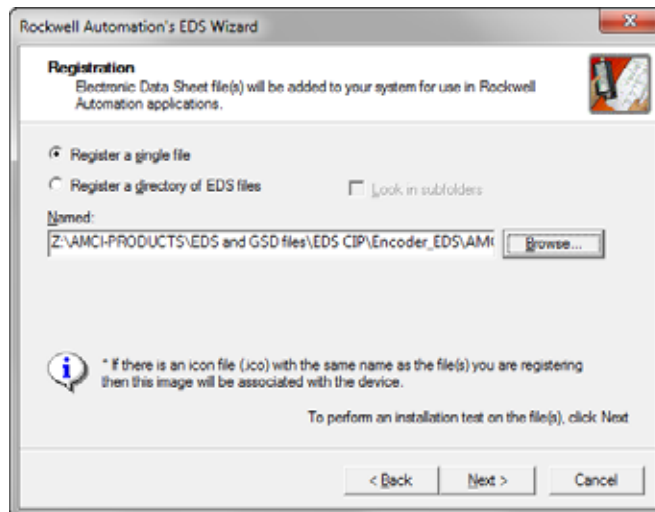

Figure T4.3 EDS Registration Screen

3) Click on the [Browse...] button and browse to the folder that contains the extracted EDS file you downloaded from the AMCI website. Select the EDS file and click on the [Open] button to return to the registration screen. Click on the [Next >] button to advance to the EDS file test screen.

4.2 Install the EDS file (continued)

4.2.2 Install the EDS File (continued)

- 4) Once at the EDS File Installation Test Results screen, expand the tree as needed to view the results of the installation test for the EDS file. You should see a green check mark next to the file name indicating that the EDS file is correct.

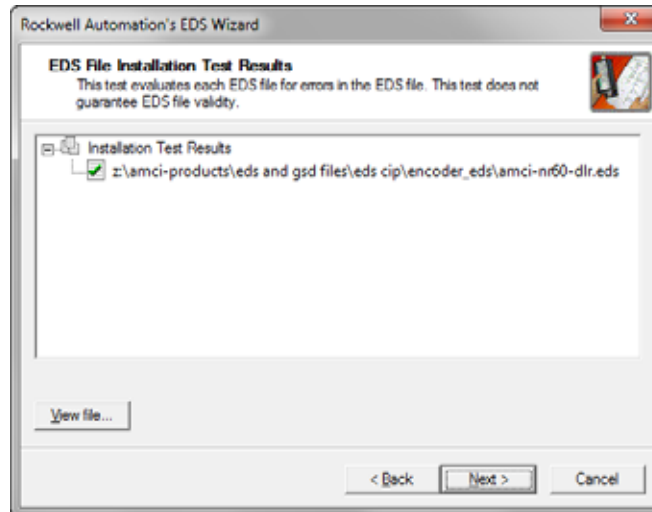

Figure T4.4 EDS Test Screen

- 5) Press on the [Next >] button to advance to the Change Graphic Image screen. This screen gives you the ability to change the icon associated with the device.

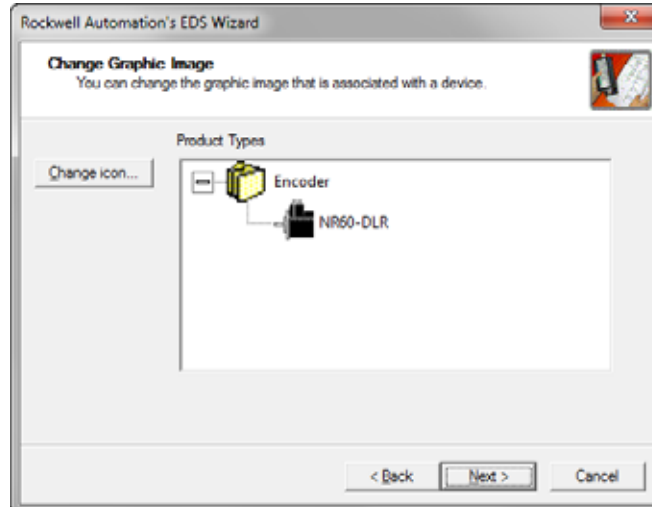

Figure T4.5 Change ECS Icon Screen

- 6) Click on the [Change icon...] button. In the window that opens, click on [Browse...] and browse to the folder that contains the extracted EDS and icon files you downloaded from the AMCI website.
- 7) Select the icon file (*.ico) associated with the device. Click on the [Open] button and then on [OK] to return to the Change Graphic Image screen.
- 8) Click on the [Next...] button to advance to the completion screen. The Completion screen tells you that you have successfully completed the wizard.
- 9) Click on the [Finish] button to exit the EDS wizard.

4.3 Host System Configuration

Studio 5000 is used to configure both the ControlLogix and CompactLogix platforms. When using these platforms, you have the option of using a separate Ethernet Bridge module or an Ethernet port built into the processor.

If the Ethernet port is built into processor, the only step you have to take before adding an AMCI NR60E2 is to create a new project with the correct processor or modify an existing project. Once this is done, the Ethernet port will automatically appear in the Project Tree. If you are using an Ethernet bridge module, you will have to add it to the I/O Configuration tree before adding the unit to your project.

Refer to your Rockwell Automation documentation if you need instructions for configuring the ethernet port.

4.4 Add the NR60E2 to Your Project

You can add an NR60E2 to the project once the Ethernet port (built-in or bridge module) is configured. As shown in figure T4.6 below, the Ethernet port will be listed under the I/O Configuration tree.

- 1) Right click on the Ethernet port and then click on “New Module...” in the pop-up menu.

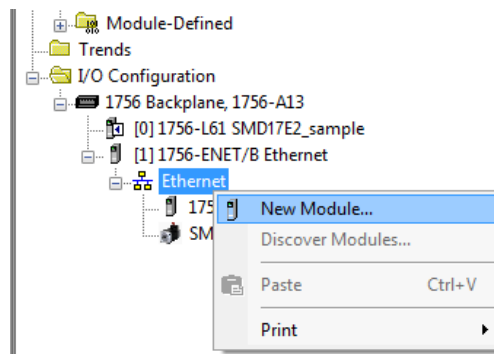

Figure T4.6 Adding an AMCI Ethernet Driver

- 2) In the resulting Select Module Type screen, select “Advanced Micro Controls Inc. (AMCI)” in the Vendor Filters. This will limit the results to catalog numbers from AMCI.
- 3) Select “AMCI-NR60-DLR” in the resulting list.
- 4) Click on the [Create] button to create the module.
- 5) Click on [Close] if necessary to close the Select Module Type screen.

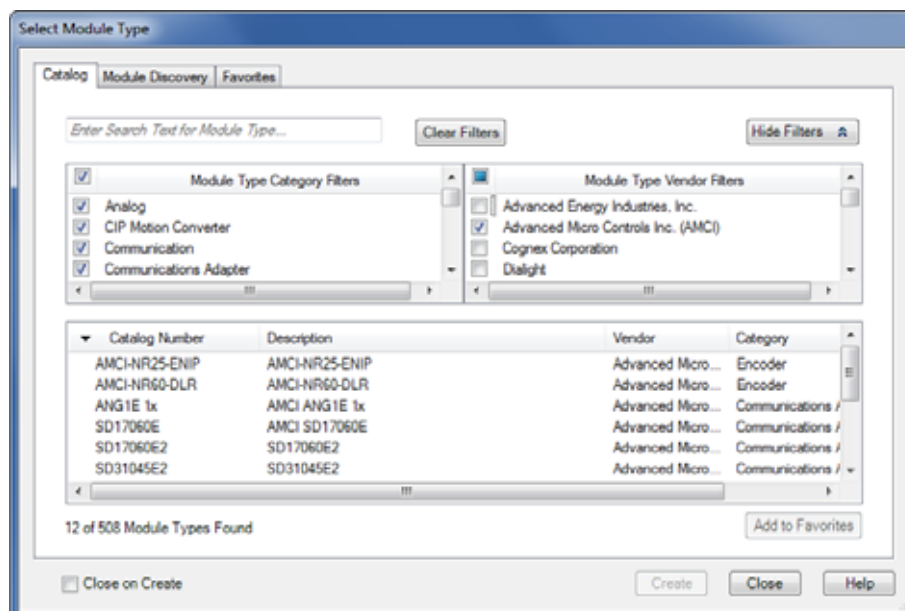



Figure T4.7 Selecting the NR60E2

4.5 NR60E2 Properties

If you are continuing from step 4.4, the resulting New Module screen is used to configure the network connection between the NR60E2 and your controller. If you need to open the screen to perform this task at a later time, right click on the unit in the project tree and then select “Properties” from the drop-down menu

NOTE  Tabs that are not listed in the steps below are filled with reasonable defaults by the EDS file.

4.5.1 General Tab

The Name, Description, and IP address of the device must be specified here. The [Change...] button allows you to change the Module Definition if needed.

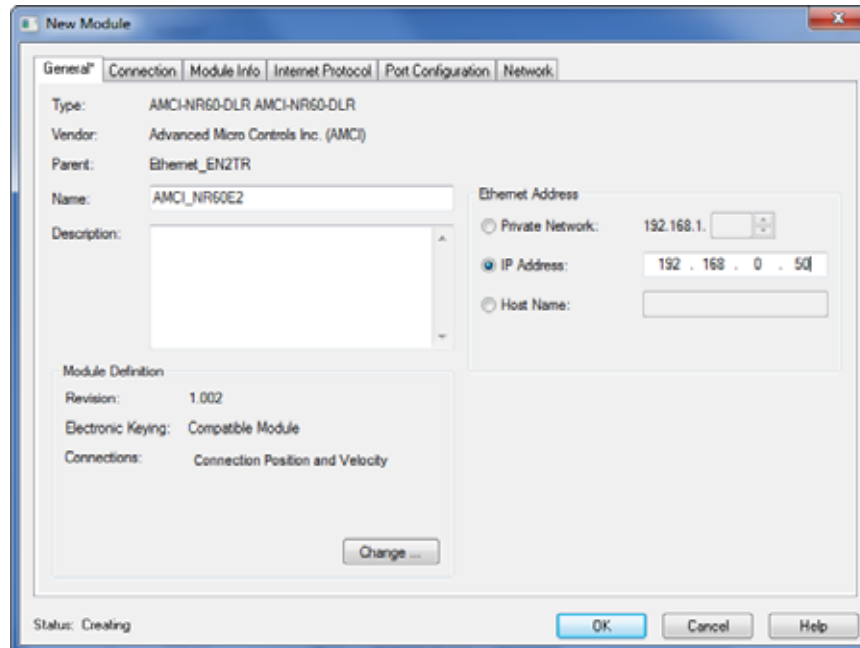

Figure T4.8 NR60E2 Properties Screen - EDS

4.5.2 Connection Tab

The default RPI time is eight milliseconds. This value can be changed in this tab.

4.6 EDS Data Formats

Input, Output, and Configuration registers are created when the NR60E2 is added to the I/O tree.

| Name | Value | Force Mask | Style | Data Type |
|---|-------|------------|---------|------------------|
| AMCI_NR60E2.C | {...} | {...} | | _000A:AMCI_NR... |
| AMCI_NR60E2.C.Direction_Counting_Toggle | 0 | | Decimal | BOOL |
| AMCI_NR60E2.C.Scaling_Function_Control | 1 | | Decimal | BOOL |
| AMCI_NR60E2.C.Measuring_Units_per_Span | 65536 | | Decimal | DINT |
| AMCI_NR60E2.C.Total_Measuring_Range | 0 | | Decimal | DINT |
| AMCI_NR60E2.C.Velocity_Format | 7940 | | Decimal | INT |
| AMCI_NR60E2:11 | {...} | {...} | | _000A:AMCI_NR... |
| AMCI_NR60E2:11.ConnectionFaulted | 0 | | Decimal | BOOL |
| AMCI_NR60E2:11.Data | {...} | {...} | Decimal | SINT[8] |
| AMCI_NR60E2:11.Data[0] | 0 | | Decimal | SINT |
| AMCI_NR60E2:11.Data[1] | 0 | | Decimal | SINT |
| AMCI_NR60E2:11.Data[2] | 0 | | Decimal | SINT |
| AMCI_NR60E2:11.Data[3] | 0 | | Decimal | SINT |
| AMCI_NR60E2:11.Data[4] | 0 | | Decimal | SINT |
| AMCI_NR60E2:11.Data[5] | 0 | | Decimal | SINT |
| AMCI_NR60E2:11.Data[6] | 0 | | Decimal | SINT |
| AMCI_NR60E2:11.Data[7] | 0 | | Decimal | SINT |
| AMCI_NR60E2:01 | {...} | {...} | | _000A:AMCI_NR... |
| AMCI_NR60E2:01.Data | {...} | {...} | Decimal | SINT[6] |
| AMCI_NR60E2:01.Data[0] | 0 | | Decimal | SINT |
| AMCI_NR60E2:01.Data[1] | 0 | | Decimal | SINT |
| AMCI_NR60E2:01.Data[2] | 0 | | Decimal | SINT |
| AMCI_NR60E2:01.Data[3] | 0 | | Decimal | SINT |
| AMCI_NR60E2:01.Data[4] | 0 | | Decimal | SINT |
| AMCI_NR60E2:01.Data[5] | 0 | | Decimal | SINT |

Figure T4.9 EDS Data Format

4.6.1 Input Data Format

When using the EDS file, the NR60E2 transmits position and velocity data as two 32-bit words. The data is transferred as eight bytes of data.

4.6.2 Buffering the Input Data

Input data is updated asynchronously to the program scan. The input data should be buffered with Synchronous Copy File instructions to guarantee stable data during the program scan.

The data from the NR60 is updated asynchronous to the program scan at the RPI time configured in the Ethernet scanner module. The following rung ensures that the data from the NR60 does not change in the middle of the ladder logic program by copying it to the internal tag array NR60_buffered_data[0] through NR60_buffered_data[1]. It is this buffered data that MUST be used by your ladder logic program for all compare purposes.

```

Synchronous Copy File
Source  AMCI_NR60:11.Data[0]
Dest   NR60_buffered_data[0]
Length 2
    
```

Figure T4.10 Buffer Input Data

- When copying input data, the data can be converted from byte to double integer format by specifying a double integer array as the destination for the instruction. The array must contain at least two double integer elements. The length of the copy must be one or two. If set to one, only the position data will be buffered. If set to two, the position and velocity data will be buffered.

4.6 EDS Data Formats (continued)

4.6.3 Output Data Format

Output data registers are typically not used with the NR60E2. Writes to the NR60E2 should be through Message Instructions. Reference chapters contain the information on using Message Instructions to write data to the NR60E2.

4.6.4 Configuration Data Format

Using an EDS file to add an NR60E2 to your project results in the creation of Configuration tags for the device. The advantage of this approach is that the configuration data is written down to the NR60E2 whenever it connects to the network. If you ever have to swap out the encoder, the new NR60E2 will be configured with the correct data as soon as it connects to the network. The disadvantage of this approach is that the Configuration data must be valid before the NR60E2 will connect to the network.

The NR60E2 must have valid data in its Configuration Registers before it will connect to the network. This is true even if you have saved a valid configuration to the flash memory of the NR60E2.

Configuration data format is shown below.

| Parameter | Size | Description |
|--|----------------|--|
| Direction Counting Toggle | Boolean | “0” = Clockwise increasing counts looking at shaft. “1” = Counter-Clockwise increasing counts looking at shaft. |
| Scaling Function Control | Boolean | “0” = Disable Scaling Function. The full resolution of 65,536 counts per turn is used for the Measuring Units per Span. “1” = Enable Scaling Function. The number of counts per turn is set by the Measuring Units of Span parameter below. |
| Counts per Turn (Measuring Units per Span) | Double Integer | Sets the number of counts generated over a single turn if the Scaling Function Control parameter equals “1”. Always sets the number of pulses per turn reported in velocity data. This value ranges from 1 to 65,536 and must be set even when the Scaling Function Control value equals zero. |
| Total Measurement Range | Double Integer | Sets the number of counts before returning to zero. This value is used regardless of the state of the Scaling Function Control parameter. Parameter ranges: <ul style="list-style-type: none"> ➤ Single Turn NR60E2: Range of 0, 2 to 65,536 ➤ 28 bit Multi-turn NR60E2: Range of 0, 2 to 268,435,456 ➤ 30 bit Multi-turn NR60E2: Range of 0, 2 to 1,073,741,824 |
| Velocity Format | Integer | Format of the velocity data. 0x1F04 (7,940) for pulses/second, 0x1F05 (7,941) for pulses/millisecond, 0x1F07 (7,943) for pulses/minute or 0x1F0F (7,951) for revolutions/minute. |

Table T4.1 EDS Configuration Data Format

Notes

IMPLICIT COMMUNICATIONS WITHOUT AN EDS

This chapter tells you how to configure implicit connections in EtherNet/IP systems that do not use EDS files. Implicit connections can be used to read position and velocity data from the NR60E2. Configuring the NR60E2, and presetting the position, requires explicit messaging. Refer to the next chapter for information on using message instructions for explicit messaging.

Rockwell Automation's RSLogix 5000 version 20 software is used for the example installation in this chapter.

5.1 Host System Configuration

RSLogix 5000 is used to configure both the ControlLogix and CompactLogix platforms. When using these platforms, you will use a separate Ethernet Bridge module or an Ethernet port built into the processor.

If the Ethernet port is built into processor, the only step you have to take before adding the NR60E2 is to create a new project with the correct processor or modify an existing project. Once this is done, the Ethernet port will automatically appear in the Project Tree. If you are using an Ethernet bridge module, you will have to add it to the I/O Configuration tree before adding the driver to your project.

Refer to your Rockwell Automation documentation if you need instructions for configuring the ethernet port.

5.2 Add the NR60E2

You can add the NR60E2 to the project once the Ethernet port (built-in or bridge module) is configured.

1) Right click on the Ethernet port and then click on "New Module..." in the pop-up menu.

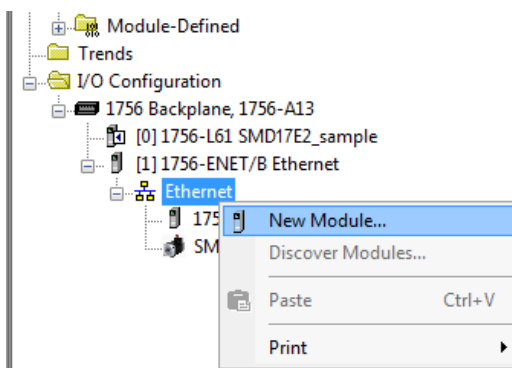

Figure T5.1 Adding an AMCI NR60E2

5.2 Add the NR60E2 (continued)

- 2) In the resulting Select Module Type screen, type “generic” into the filter as shown in figure T5.2. This will limit the results in the Catalog Number list.
- 3) Select the Catalog Number “ETHERNET-MODULE” in the list.
- 4) Click on the [Create] button to create the module.
- 5) Click on [Close] if necessary to close the Select Module Type screen.

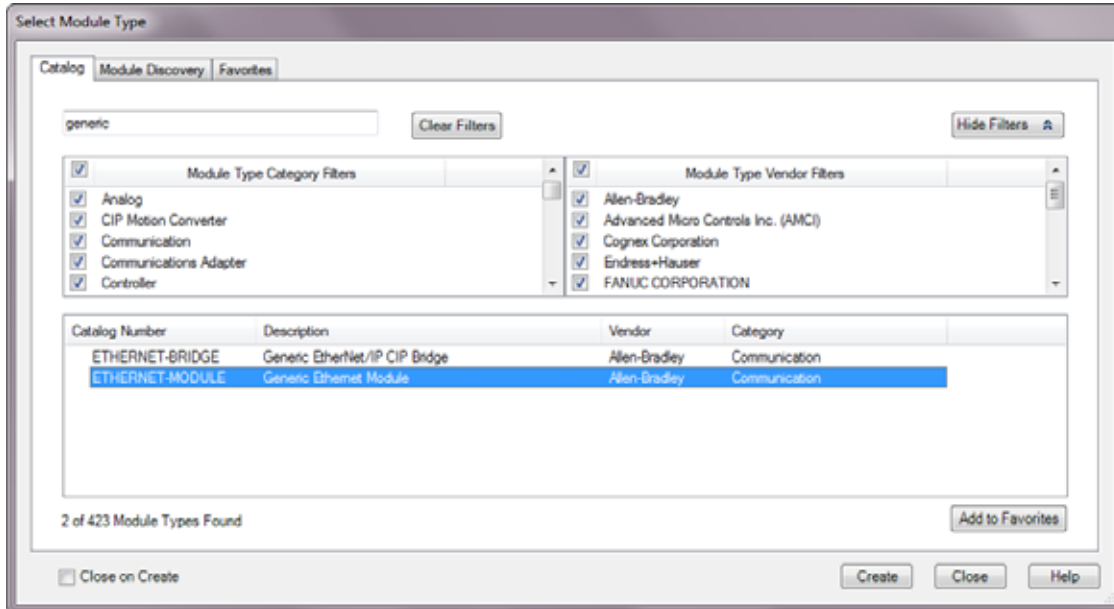

Figure T5.2 Selecting a Generic Device

5.2 Add the NR60E2 (continued)

- 6) Set the following parameters in the Module Properties window. All parameters not listed here are optional. Figure T5.3 shows a completed screen.

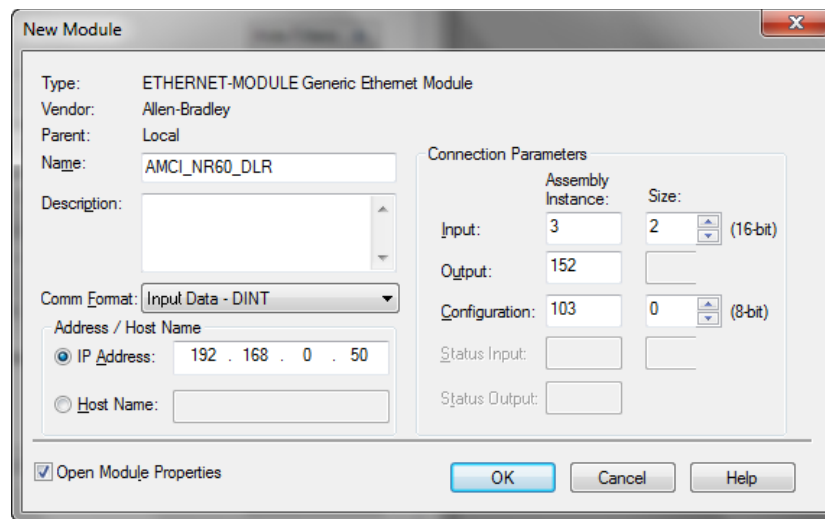

Figure T5.3 Sample NR60E2 Configuration Screen

- **Name:** A descriptive name for the NR60E2
- **Comm Format:** Input Data - DINT



The Comm Format defaults to Data - DINT. The NR60E2 will not be able to communicate with the host controller if this format is not changed to *Input Data - DINT* when the device is added to the system. Once added, the Comm Format cannot be changed. The device must be deleted and added to the project again if the Comm Format is incorrect.

- **IP Address:** Must be the address you set for the NR60E2. Refer to the [Set the IP Address and Protocol](#) task chapter starting on page 33 for information on setting the IP Address of the unit.
- **Input:** You have two choices:

| Assembly | Size | Data |
|----------|------|--|
| 1 | 1 | 32 bit Position Value |
| 3 | 2 | 32 bit Position Value and 32 bit Velocity Data |

Table T5.1 Input Assembly Instances

- **Configuration:** Assembly Instance = 103, Size = 0

- 7) Click on [OK] to close the window.

5.2 Add the NR60E2 (continued)

- 8) A “Module Properties” window will automatically open if the “Open Module Properties” checkbox was left at its default setting. If the “Module Properties” window did not open, double click on the name you gave the NR60E2 in the I/O Configuration tree to open the window.
- 9) Click on the “Connections” tab and set the RPI time that is required for your system. The suggested minimum RPI time for an NR60E2 is two milliseconds. The number of nodes on the network has an effect on the minimum RPI time. (The unit has been tested to 1 millisecond with an eight node ring.) You may have to increase this RPI time if your network is heavily loaded. The remaining checkboxes can be left at their default settings. {The Unicast Connection field that is shown as checked in the figure is an optional setting.} When done, click on [OK] to complete the setup.

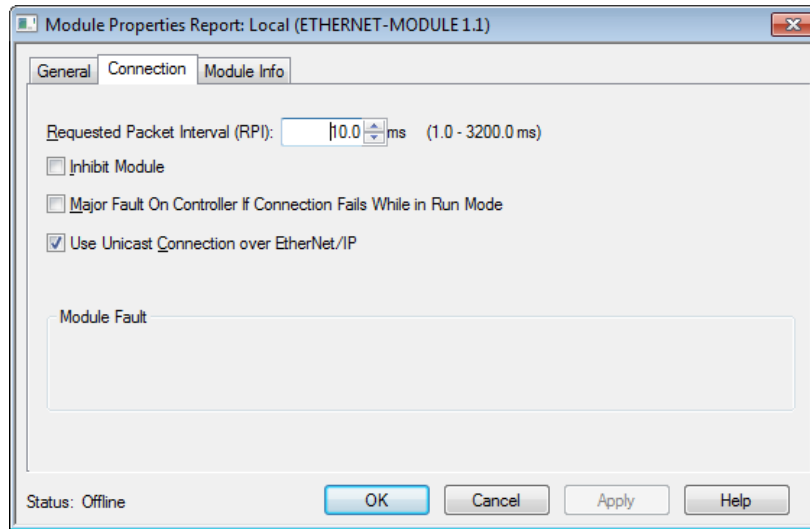

Figure T5.4 Setting the RPI Time

5.3 Check for Communication Errors

You can immediately check for errors if you are on-line with the processor while setting up the NR60E2. These error codes will appear in the Module Fault section of the Connection tab of the Module Properties window.

- **Error Code 16#0315 Connection Request Error: Invalid Segment Type.** You have specified an invalid assembly instance in the connection parameters.
- **No communications, but no error code.** Most commonly caused when the Comm Format not set to “Input Data - DINT” or when the number of inputs words is incorrect.

5.4 Implicit Messaging Data Format

5.4.1 Assembly Instance = 1

As shown in the table below, when you set the Input Assembly Instance to 1, the input data consists of the position value transferred as a single 32 bit double integer.

| DINT # | Description |
|--------|---|
| 0 | Position Value. The maximum position value depends on your NR60E2 model and the programmed counts per turn. The maximum value in all cases is 1,073,741,823 (16#3FFF FFFF) |

Table T5.2 Input Data, Position Only

5.4 Implicit Messaging Data Format (continued)

5.4.2 Assembly Instance = 3

As shown in the table below, when you set the Input Assembly Instance to 3, the input data consists of the position value and velocity data transferred as two 32 bit double integers.

| DINT # | Description |
|--------|--|
| 0 | Position Data. The maximum position value depends on your NR60E2 model and the programmed counts per turn. The maximum value in all cases is 1,073,741,823 (16#3FFF FFFF). |
| 1 | Velocity Data. The units of measure of the velocity data is set by the Velocity Format parameter in the Configuration Data. If the Scaling Function Control bit is ever set to a “1”, the position data used to calculate the velocity data is always scaled by the Measuring Units per Span parameter. |

Table T5.3 Input Data, Position and Velocity

5.5 Buffer Implicit Messaging Data

Implicit Messaging data is updated asynchronously to the scan at the programmed RPI time. Therefore, this data should be buffered by copying it to holding registers using a Synchronous Copy (CPS) instruction. The holding registers are then used by your PLC program. If the data is not buffered, it can change during a program scan, resulting in logical errors that may cause a machine malfunction.

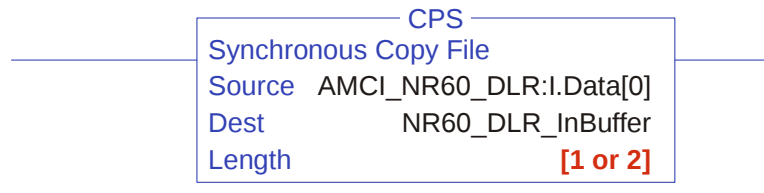

Figure T5.5 Sample CPS Instruction

The amount of data to buffer depends on the Input Assembly Instance you chose while adding the NR60E2 to your host controller. When transferring position data only (Assembly Instance =1), the length should be “1”. When transferring position and velocity data, (Assembly Instance = 3), the length should be “2”.

Notes

ETHERNET/IP EXPLICIT MESSAGING

All controllers that support EtherNet/IP support explicit messaging. When using explicit messaging, Message Instructions must be added to your program to communicate with the NR60E2. Explicit messaging must be used to configure the device or preset the position value.

Rockwell Automation controllers which are programmed with the RSLogix 500 software only support explicit messaging. A MicroLogix 1100 will be used as an example in this chapter. In Rockwell Automation systems, RSLogix 500 version 8.0 or above is required to configure Message Instructions to communicate with an EtherNet/IP device. Message Instructions do not work correctly in version 10 of RSLogix 500.

6.1 Custom Assembly Instances

Each NR60E2 supports two custom assemblies to read data from the unit. Each NR60E2 also supports six custom assemblies to write configuration data or commands to the unit.

In addition to the custom assemblies, the NR60E2 also implements the Position Sensor Object as defined in revision 2 of the CIP specification. Explicit messaging can be used to access all of the attributes defined by the Position Sensor Object. Additional information on the Position Sensor Object can be found in the *CIP Position Sensor Object* section, starting on page 67.

6.1.1 Read Assemblies

Two custom assemblies are available to read data from the NR60E2.

| | Service Type | Service Code (hex) | Class (hex) | Attribute (hex) | Instance (decimal) | Size (Bytes) |
|----------------------------|---------------|--------------------|-------------|-----------------|--------------------|--------------|
| Read Position | Read Assembly | E | 4 | 3 | 1 | 4 |
| Read Position and Velocity | Read Assembly | E | 4 | 3 | 3 | 8 |

Table T6.1 Read Message Instruction Attributes

6.1.2 Write Assemblies

Six custom assemblies are available to write data to the NR60E2.

| | Service Type | Service Code (hex) | Class (hex) | Attribute (hex) | Instance (decimal) | Size (Bytes) |
|---------------------------------------|----------------------|--------------------|-------------|-----------------|--------------------|--------------|
| Configure NR60E2 | Set_Attribute_Single | 10 | 4 | 3 | 103 | 12 |
| Preset Position | Set_Attribute_Single | 10 | 23 | 13 | 1 | 4 |
| Save to Flash | Custom | 16 | 23 | 0 | 0 | 0 |
| Restore from Flash | Custom | 15 | 23 | 0 | 0 | 0 |
| Restore Factory Defaults [†] | Custom | 5 | 23 | 0 | 0 | 0 |
| Reset | Custom | 5 | 1 | 0 | 1 | 0 |

Table T6.2 Write Message Instruction Attributes

[†] Restore Factory Defaults does not affect the IP addressing information. Parameter values are restored to RAM. A separate Save to Flash command is required to save the factory defaults to flash memory.

6.2 RSLogix 500 Configuration

6.2.1 Configure the Host Controller's Ethernet Settings

You should configure the Ethernet settings of your host controller before adding the NR60E2 to your project. Refer to RA documentation for information on configuring your controller.

6.2.2 Create a Message Data File for each NR60E2

Each NR60E2 in the system requires its own Message (MG) data file, and the minimum number of elements in the MG file must be greater than or equal to the number of Message Instructions that reads or writes data to that particular NR60E2.

Right click on the Data Files icon in the project tree and select “New...”. In the resulting window, change the Type field to “Message”. As a minimum, set the “Elements” field to the number of Message Instructions associated with the NR60E2. (You can create a file that contains more elements than is needed without causing an error.) All other fields are optional and can be left at their default settings or changed.

6.2.3 Create an Extended Routing Information (RIX) Data File for each NR60E2

Each NR60E2 in the system requires its own Extended Routing Information (RIX) data file, and the minimum number of elements in the RIX file must be greater than or equal to the number of Message Instructions that reads or writes data to that particular NR60E2.

Right click on the Data Files icon in the project tree and select “New...”. In the resulting window, change the Type field to “Extended Routing Information”. As a minimum, set the “Elements” field to the number of Message Instructions associated with the NR60E2. (You can create a file that contains more elements than what is needed without causing an error.) All other fields are optional and can be left at their default settings or changed.

6.2.4 Create an Integer File for each NR60E2

Create one or more Integer files to store the data read from and written to the NR60E2. You can also set aside space in an existing Integer file for this data.

- ▶ **Read Data:** This file must be at least two words in length for Position data or four words in length for Position and Velocity data.
- ▶ **Write Data:** This file must be at least six words in length to hold the configuration data. An additional two words are required to hold the Position Preset Value if used.
- ▶ **A Message (MG) data file.** This file must have at least two elements, one to control the Read Operation and one to control the Write Operation.

6.3 Add the Read Message Instructions

Figure T6.1 shows the configuration screen when setting up a message instruction to communicate with an NR60E2 device. Note that the screen will change as you enter data.

6.3.1 General Tab Settings

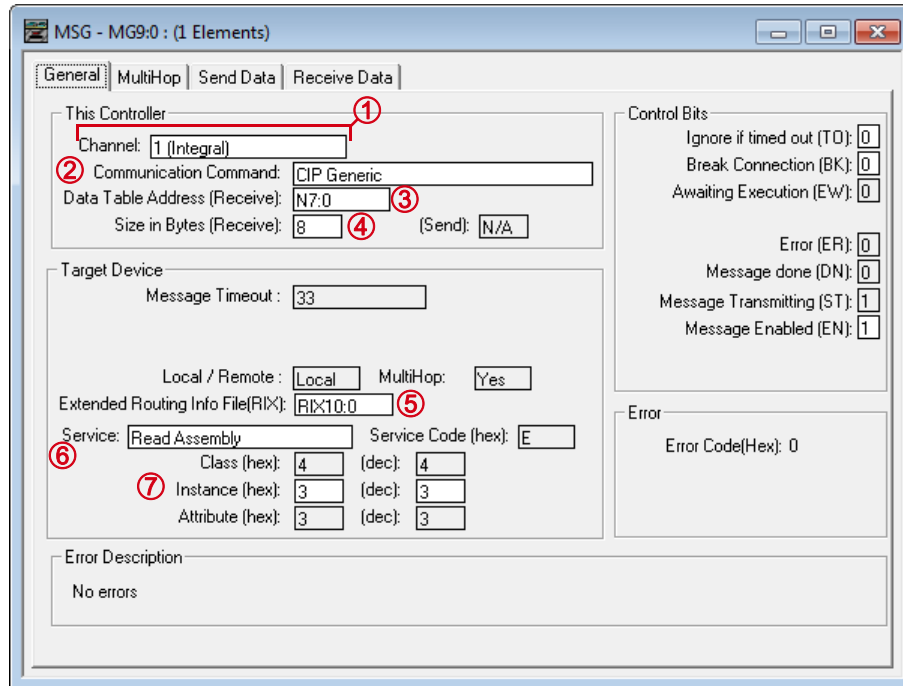

Figure T6.1 RSLogix 500 MSG Example

- 1) **Communications Channel:** Data path out of the controller. This will either be an integral port or a port on an expansion module.
- 2) **Communications Command:** Always set to “CIP Generic”.
- 3) **Data Table Address (Receive):** The starting address in memory that will be the destination of the data you are reading from the NR60E2. This address is typically in an Integer (N) file.
- 4) **Size in Bytes (Receive):** The length of the data you are reading from the NR60E2. This length is always in bytes. See table T6.1, *Read Message Instruction Attributes* on page 59 for the list of options.
- 5) **Extended Routing Info File (RIX):** Address of the RIX file you created when adding the NR60E2 to your project.
- 6) **Service Field:** Double click in the Service field, select “Read Assembly” for the service type and press [Enter]. The Service Code field will change to “E”, the Class field will change to “4”, and the Attribute field will change to “3”.
- 7) **Instance:** This field controls which data is returned by the NR60E2 when the message instruction is executed. See table T6.1, *Read Message Instruction Attributes* on page 59 for the list of options.

6.3 Add the Read Message Instructions (continued)

6.3.2 MultiHop Tab Settings

Enter the IP address of the NR60E2 in the “To Address” field.

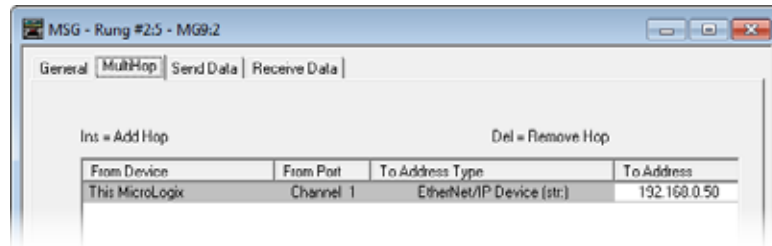

Figure T6.2 MultiHop Address Setting

6.4 Position and Velocity Data Formats

6.4.1 Assembly Instance = 1

As shown in the table below, when you set the Input Assembly Instance to 1, the input data consists of the position value in two 16 bit words.

| Word # | Description | |
|--------|---|---------|
| 0 | Position Value. The maximum position value depends on your NR60E2 model and the programmed Total Measurement Range. The maximum value in all cases is 1,073,741,823 (16#3FFF FFFF). Note that the two 16 bit registers are combined into a single 32 bit data word. The values on the right show the register values in hexadecimal if the position value is 1,274,237 (16# 0013 717D) | 16#717D |
| 1 | | 16#0013 |

Table T6.3 Input Data, Position Only

6.4.2 Assembly Instance = 3

As shown in the table below, when you set the Input Assembly Instance to 3, the input data consists of the position value and velocity data in a total of four 16 bit words.

| Word # | Description | |
|--------|---|---------|
| 0 | Position Data. The maximum position value depends on your NR60E2 model and the programmed Total Measurement Range. The maximum value in all cases is 1,073,741,823 (16#3FFF FFFF). Note that the two 16 bit registers are combined into a single 32 bit data word. The values on the right show the register values in hexadecimal if the position value is 1,274,237 (16# 0013 717D) | 16#717D |
| 1 | | 16#0013 |
| 2 | Velocity Data. The units of measure of the velocity data is set by the Velocity Format parameter in the Configuration Data. If the Scaling Function Control bit is ever set to a “1”, the position data used to calculate the velocity data is always scaled by the Measuring Units per Span parameter. Note that the two 16 bit registers are combined into a single 32 bit data word. The values on the right show the register values in hexadecimal if the velocity value is 461,725 (16# 0007 0B9D) | 16#0B9D |
| 3 | | 16#0007 |

Table T6.4 Input Data, Position and Velocity

6.5 Add the Write Message Instructions

Figure T6.3 shows the configuration screen when setting up a message instruction to write to an NR60E2 device. Note that the screen will change as you enter data.

6.5.1 General Tab Settings

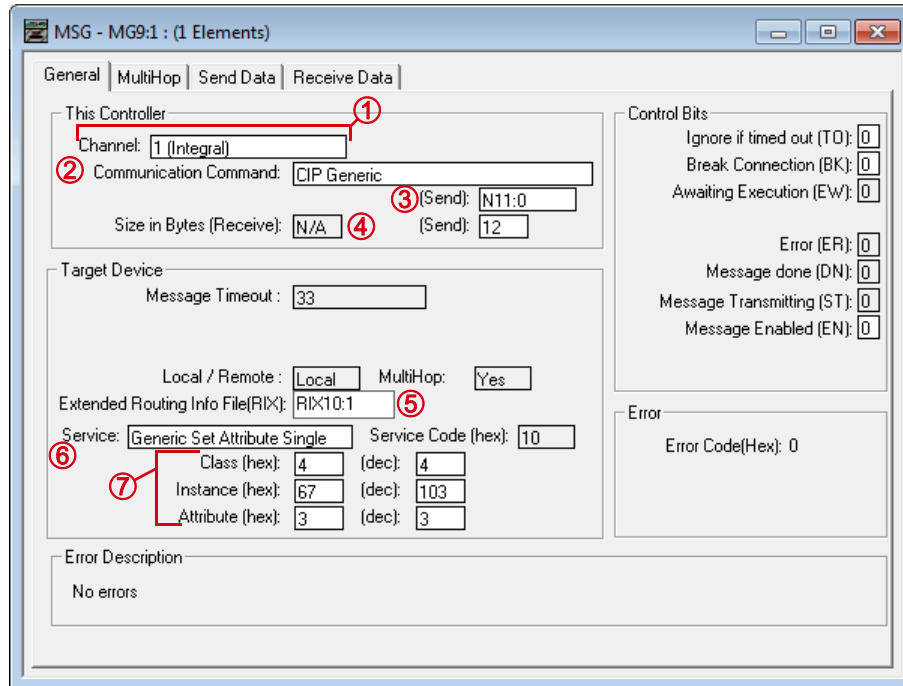

Figure T6.3 RSLogix 500 MSG Example

- 1) **Communications Channel:** Data path out of the controller. This will either be an integral port or a port on an expansion module.
- 2) **Communications Command:** Always set to “CIP Generic”.
- 3) **Data Table Address (Send):** The starting address in memory that will be the source of the data you are writing to the NR60E2. See table T6.2, *Write Message Instruction Attributes* on page 59 for the list of options.
- 4) **Size in Bytes (Send):** The length of the data you are writing to the NR60E2. This length is always in bytes. See table T6.2, *Write Message Instruction Attributes* on page 59 for the list of options.
- 5) **Extended Routing Info File (RIX):** Address of the RIX file you created when adding the NR60E2 to your project.
- 6) **Service Field:** Will be set to “Generic Set Attribute Single” or “Custom” depending on the action the message instruction will be performing. When set to “Custom” you will have to enter the required Service Code. See table T6.2, *Write Message Instruction Attributes* on page 59 for the list of options.
- 7) **Class, Instance, Attribute:** The settings for these fields depend on the action the message instruction will be performing. See table T6.2, *Write Message Instruction Attributes* on page 59 for the list of options.

6.5 Add the Write Message Instructions (continued)

6.5.2 MultiHop Tab Settings

Enter the IP address of the NR60E2 in the “To Address” field.

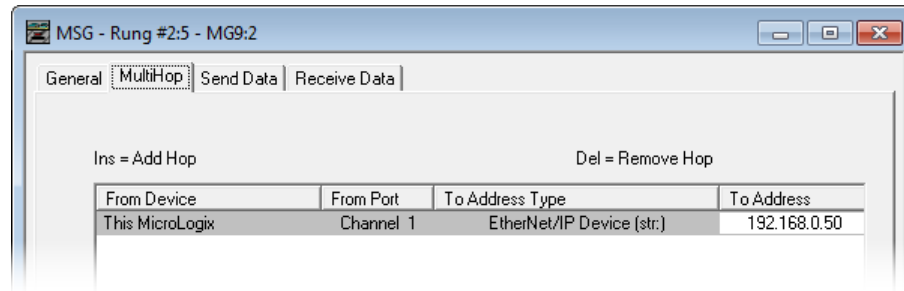

Figure T6.4 MultiHop Address Setting

6.6 Write Data Formats

6.6.1 Configure NR60E2 Data Format



This command writes parameter values to RAM. These parameter values will be lost once power is cycled to the NR60E2. If you wish to use these parameters after cycling power, you must write them to the NR60E2 again, or you must issue a *Save To Flash Instruction* as described on page 65.

Twelve bytes of data must be written to the NR60E2 as part of this instruction. Table T6.5 lists the format of the data words. The location of these words must be entered into the message instruction using the *Source Element* field. All data must be present and valid when programming the NR60E2.

| Byte # | Word # | Parameter | Description | |
|--------|--------|---------------------------|--|----|
| 0 | 1 | Direction Counting Toggle | “0” = Clockwise increasing counts looking at shaft. “1” = Counter-Clockwise increasing counts looking at shaft. | |
| 1 | | Scaling Function Control | “0” = Disable Scaling Function. The full resolution of 65,536 counts per turn is used for the Measuring Units per Span. “1” = Enable Scaling Function. The number of counts per turn is set by the Measuring Units of Span parameter below. | |
| 2 | 2 | Counts per Turn | Sets the number of counts generated over a single turn if the Scaling Function Control parameter equals “1”. Always sets the number of pulses per turn reported in velocity data. This value ranges from 1 to 65,536 and must be set even when the Scaling Function Control value equals zero. A value of 39,370 (16#99CA) is shown to the right. | CA |
| 3 | | | | 99 |
| 4 | | | | 00 |
| 5 | 3 | | | 00 |
| 6 | 4 | Total Measurement Range | Sets the number of counts before returning to zero. This value is used regardless of the state of the Scaling Function Control parameter. Parameter ranges: <ul style="list-style-type: none"> ➤ Single Turn NR60E2: Range of 0, 2 to 65,536 ➤ 28 bit Multi-turn NR60E2: Range of 0, 2 to 268,435,456 ➤ 30 bit Multi-turn NR60E2: Range of 0, 2 to 1,073,741,824 A value of 648,000 (16#0009 E340) is shown to the right. | 40 |
| 7 | | | | E3 |
| 8 | | | | 09 |
| 9 | 5 | | | 00 |
| 10 | 6 | Velocity Format | Format of the velocity data. Byte 11 must always equal “1F”. Byte 10 = “04” for pulses/second, “05” for pulses/millisecond, “07” for pulses/minute or “0F” for revolutions/minute. A value of “1F04” to the right would set the unit of measure to pulses/second. | 04 |
| 11 | | | | 1F |

Table T6.5 Program Parameters Data Format

6.6 Write Data Formats (continued)

6.6.2 Preset Position Instruction

NOTE

This command alters the internal position offset. If the Total Measurement Range equals zero:

- The offset is stored in RAM.
- This offset will be lost once power is cycled to the NR60E2.
- If you wish to save the internal position offset, you must issue a *Save To Flash Instruction* as described below.

If the Total Measurement Range does not equal zero, the position offset is automatically stored in nonvolatile memory. A Save To Flash Instruction is not required.

Four bytes of data must be written to the NR60E2 as part of this instruction. Table T6.6 lists the format of the data words. The location of these words must be entered into the message instruction using the *Source Element* field.

| Byte # | Word # | Description | |
|--------|--------|--|----|
| 0 | 1 | Preset Value. The value that you want the position to become when you issue this command. The Preset Value can be any number between 0 and the configured full scale count of the encoder. The values on the right show the register values in hexadecimal if the Preset Value is 704,303 (16# 000A BF2F) | 2F |
| 1 | | | BF |
| 2 | 2 | The type of NR60E2 that you are using, as well as the Scaling Function Control and Total Measurement Range parameters affect the range of the Preset Value. See <i>Preset Value</i> on page 19 for the acceptable ranges of parameter values for the different NR60E2 models. | 0A |
| 3 | | | 00 |

Table T6.6 Preset Position Data Format

6.6.3 Save To Flash Instruction

This instruction saves parameter values and the internal position offset to nonvolatile memory. Additional data is not sent with this instruction. Set data length fields to 0 and leave the source field blank.

6.6.4 Restore From Flash Instruction

This instruction restores parameter values to the last values saved in nonvolatile memory. Additional data is not sent with this instruction. Set data length fields to 0 and leave the source field blank.

6.6.5 Restore Factory Defaults Instruction

This instruction restores parameter values to their factory defaults. The Attribute field is not used and should be set to zero. Additional data is not sent with this instruction. Set data length fields to zero and leave the source field blank.

NOTE

This instruction does not reset the IP Address, Network Mask, or Default Gateway parameters. See Task 3, *Set the IP Address and Protocol*, which starts on page 33, for information on changing these settings.

NOTE

This command stores the factory default values in RAM memory. You must issue a separate Save To Flash instruction to store these values in non-volatile memory.

6.6.6 Reset Device Instruction

This instruction forces the NR60E2 to perform a hardware reset. Network communications will be lost momentarily and all parameter values will be restored from nonvolatile memory. The Attribute field is not used and should be set to zero. Additional data is not sent with this instruction. Set data length fields to zero and leave the source field blank.

6.7 Troubleshooting

If you are unable to communicate with the NR60E2, the problem may be that the Ethernet port of your PLC has not been configured. To check this on a MicroLogix 1100:

- 1) Double click on Channel Configuration in the Project Tree and then select the Channel 1 tab. The following window will open.

The screenshot shows the 'Channel Configuration' dialog box with the 'Channel 1' tab selected. The 'Driver' is set to 'Ethernet'. The 'Hardware Address' is 'C8:8E:D1:B1:4A:56'. The 'IP Address' is '192.168.0.1', 'Subnet Mask' is '255.255.255.0', and 'Gateway Address' is '0.0.0.0'. The 'Network Link ID' is '0'. Under 'Protocol Control', 'BOOTP Enable', 'DHCP Enable', 'SNMP Server Enable', and 'SMTP Client Enable' are unchecked, while 'HTTP Server Enable' is checked. 'Msg Connection Timeout (x 1mS)' is '15000', 'Msg Reply Timeout (x 1mS)' is '3000', and 'Inactivity Timeout (x Min)' is '30'. 'Auto Negotiate' is checked, and 'Port Setting' is '10/100 Mbps Full Duplex/Half Duplex'. 'Contact' and 'Location' fields are empty. Buttons for 'OK', 'Cancel', 'Apply', and 'Help' are at the bottom.

Figure R2.2 MicroLogix Ethernet Configuration Screen

- 2) Enter the IP address and Subnet Mask of your MicroLogix 1100, (not the address of the NR60E2) and click on [Apply]. The Ethernet Port should now be working.



AMCI is aware of an issue with the RIX data type in version 10 of RSLogix 500. If you are experiencing communications errors and are running version 10, please contact Rockwell Automation for support.

CIP POSITION SENSOR OBJECT

Common Industrial Protocol

EtherNet/IP is a protocol stack that implements the Common Industrial Protocol (CIP) over Ethernet using TCP/IP. The CIP is sponsored by the Open DeviceNet Vendors Association (ODVA) and is implemented over a variety of networks. The NR60E2 follows the Encoder Device Profile that is defined in the CIP specification. The Configuration and Programming instances in previous chapters are actually custom instances that simplify configuring and programming the encoder.

In addition to these custom instances, the NR60E2 implements the Position Sensor Object, which is a mandatory object for every product that implements the Encoder Device Profile as defined in the specification. The explicit messages that are used to preset the position value and save the programmed parameters are two commands defined in the Position Sensor Object.

The NR60E2 implements the CIP revision 2 definition of the Position Sensor Object.

NOTE  Using the Position Sensor Object to communicate with the NR60E2 is *completely optional*. Most applications should communicate with the NR60E2 using the custom instances as explained in the previous chapters because it will greatly simplify your PLC programming. The only reasons to use the Position Sensor Object is if you need extremely fine grain control over communications with the NR60E2 or if you use EtherNet/IP encoders from multiple vendors and you decide to write code that can be used with any of these sensors.

Supported Services

The following table lists the common services implemented by the NR60E2 for the Position Sensor Object.

| Service Code | Implemented | | Service Name | Description of Service |
|--------------|-------------|----------|----------------------|--|
| | Class | Instance | | |
| 16#05 | Yes | No | Reset | Resets all parameter values to the factory default |
| 16#0E | Yes | Yes | Get_Attribute_Single | Returns the contents of the specified attribute |
| 16#10 | No | Yes | Set_Attribute_Single | Modifies an attribute value |
| 16#15 | Yes | No | Restore | Restores all parameter values from non-volatile storage |
| 16#16 | Yes | No | Save | Saves all programmable parameters to the non-volatile storage including the position offset derived from setting the Preset Value, (Attribute 16#13) |

The services that are implemented only on the Class level (not on the Instance) should address Instance 0.

Table R3.1 Supported Services

- Service Code 16#0E, *Get_Attribute_Single* is used to read data from the Position Sensor Object class.
- Service Code 16#10, *Set_Attribute_Single* is used to write data to the Position Sensor Object class.

Supported Class Attributes

The only supported Class attribute is 1 and it returns the revision number of the definition of the object. Because the NR60E2 implements the CIP revision 2 definition of the Position Sensor Object, this attribute will always return a value of “2”.

Supported Instance Attributes

Table R3.3 on the following two pages lists all of instance attributes implemented by the NR60E2. Table R3.2 below describes the Data Type values used in this table.

| Data Type | Length | Description |
|-----------|---------|---|
| BOOLEAN | 8 bits | Holds single on/off (true/false) value |
| BYTE | 8 bits | Holds up to 8 bits of data which should not be considered to be a scalar value |
| USINT | 8 bits | Unsigned 8 bit value |
| WORD | 16 bits | Holds up to 16 bits of data which should not be considered to be a scalar value |
| UINT | 16 bits | Unsigned 16 bit integer value |
| DINT | 32 bits | Signed 32 bit integer value |
| UDINT | 32 bits | Unsigned 32 bit integer value |

Table R3.2 Explanation of Data Types

NOTE  When programming these instances, always use a Class Code of 16#23.

| Attrib. ID | Access | Name | Data Type | Description |
|------------|--------|--|---------------|--|
| 16#01 - 1 | Get | Number of Attributes | USINT | Number of supported Attributes = 21 |
| 16#02 - 2 | Get | Attribute List | Array of BYTE | List of supported Attributes = 01, 02, 0A, 0B, 0C ...71hex |
| 16#0A - 10 | Get | Position Value Signed | DINT | Current position value |
| 16#0B - 11 | Get | Position Sensor Type | WORD | Specifies the device type 1 = Single turn absolute rotary encoder 2 = Multi-turn absolute rotary encoder |
| 16#0C - 12 | Set | Direction Counting Toggle | BOOLEAN | Controls the counting direction: 0 = CW 1 = CCW |
| 16#0E - 14 | Set | Scaling Function Control | BOOLEAN | Enables Scaling function 0 = OFF (65,536 counts per turn) 1 = ON (Scaling set by <i>Measuring Units per Span</i> , attribute 10hex) |
| 16#10 - 16 | Set | Measuring Units per Span (Counts per Turn) | UDINT | Resolution for one revolution: 1 to 65,536 counts per turn |
| 16#11 - 17 | Set | Total Measurement Range | UDINT | Counts before roll over to zero. Single Turn NR60E2: Range of 0, 2 to 65,536 28 bit Multi-turn NR60E2: Range of 0, 2 to 268,435,455 30 bit Multi-turn NR60E2: Range of 0, 2 to 1,073,741,823 |
| 16#13 - 19 | Set | Preset Value | DINT | Sets the position to the specified value. Calculates an internal offset that will be saved to the non-volatile storage if Save service (code 16#16) is issued. |
| 16#18 - 24 | Get | Velocity Value | DINT | Current speed. The value is in the format specified by attribute 16#19 |

(Table is continued on next page)

Supported Instance Attributes (continued)

| Attrib. ID | Access | Name | Data Type | Description |
|-------------|--------|--------------------------|-----------|--|
| 16#19 - 25 | Set | Velocity Format | WORD | Format of the velocity attribute: 16#1F04 = pulses/s 16#1F05 = pulses/ms 16#1F07 = steps/min 16#1F0F = RPM |
| 16#29 - 41 | Get | Operating Status | BYTE | Encoder diagnostic operating status. Bit 0 = Value of attribute 16#0C (12) Bit 1 = Value of attribute 16#0E (14) |
| 16#2A - 42 | Get | Physical Resolution Span | UDINT | Physical resolution of the single-turn resolver sensor |
| 16#2B - 43 | Get | Number of Spans | UINT | Maximum number of revolutions that could be measured. |
| 16#2C - 44 | Get | Alarms | WORD | Indicates a malfunction has occurred. |
| 16#2D - 45 | Get | Supported Alarms | WORD | Information about supported alarms |
| 16#2E - 46 | Get | Alarm Flag | BOOLEAN | Indicates that an alarm error occurred: 0 = No errors 1 = Alarm Error |
| 16#33 - 51 | Get | Offset Value | DINT | The internal position offset that is calculated after applying the Preset Value through attribute 13hex (19) |
| 16#64 - 100 | Set | Device Type | DINT | The way the device identifies itself: 16#22 (default) = Encoder device 16#00 = Generic device |
| 16#70 - 112 | Get | Actual Sensor Reading | UDINT | Raw position value read from NR60E2 |
| 16#71 - 113 | Get | Time Stamp | UDINT | Value increments every 400 nanoseconds. |

Table R3.3 Supported Instance Attributes



For detailed description of the Attributes, see the CIP definition.

Supported Alarms

The NR60E2 supports the following operational alarm.

- Diagnostic Error

This alarm is set when the NR60E2 fails its power up diagnostics. The Position Error alarm is also set to indicate that the position data may be incorrect.

Attributes 16#2D, *Supported Alarms*, 16#2C, *Alarms*, and 16#2E *Alarm Flag* indicate something about the alarms supported by the NR60E2.

- **16#2D: Supported Alarms** – Reading this attribute returns a value of 3, indicating that the Position Error alarm and Diagnostic Error alarms are both used.
- **16#2C: Alarms** – Reading this attribute will return a value of zero if no alarms have occurred and a value of three if an alarm has occurred.
- **16#2E: Alarm Flag** – Reading this attribute will return a value of zero if no alarms have occurred and a value of one if an alarm has occurred.

Notes

MODBUS TCP CONFIGURATION

NR60E2 Memory Layout

All NR60E2 encoders use four 16-bit input registers and nine 16-bit output registers. Figure R4.1 shows how these registers are mapped to the Modbus data reference. Input registers should only be read. Output registers can be read to determine the present settings of the NR60E2 and written to program the unit. The complete specification for the Modbus protocol can be downloaded at <http://www.modbus.org/specs.php>.

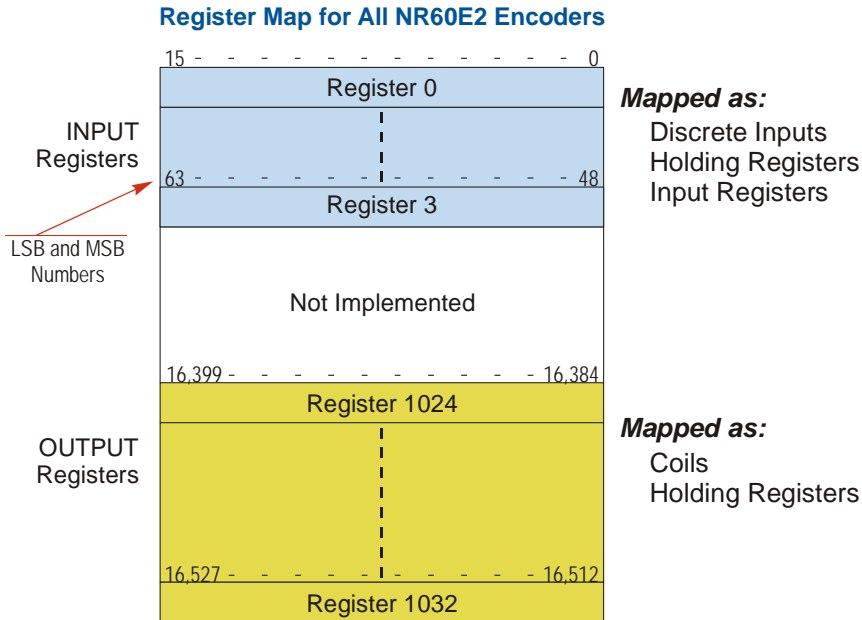

Figure R4.1 Modbus Data Reference Map

Supported Modbus Functions

| Function Code | Function Name | NR25 Register | Addressing method |
|---------------|--------------------------|----------------|--|
| 1 | Read Coils | OUTPUT | Bit: Address 16,384 through 16,527 |
| 2 | Read Discrete Inputs | INPUT | Bit: Address 0 through 63 |
| 3 | Read Holding Registers | OUTPUT & INPUT | Word: Out Regs. 1024 through 1032 In Regs. 0 though 3 |
| 4 | Read Input Registers | INPUT | Word: Registers 0 through 3 |
| 5 | Write Single Coil | OUTPUT | Bit: Address 16,384 through 16,527 |
| 6 | Write Single Register | OUTPUT | Word: Registers 1024 through 1032 |
| 15 | Write Multiple Coils | OUTPUT | Bit: Address 16,384 through 16,527 |
| 16 | Write Multiple Registers | OUTPUT | Word: Registers 1024 through 1032 |
| 22 | Mask Write Register | OUTPUT | Word: Registers 1024 through 1032 |
| 23 | Read/Write Registers | INPUT/OUTPUT | Word: Out Regs. 1024 through 1032 In Regs. 0 though 3 |

Table R4.1 Supported Modbus Functions

Supported Modbus Exceptions

| Code | Name | Description |
|------|----------------------|---|
| 01 | Illegal function | The NR60E2 does not support the function code in the query |
| 02 | Illegal data address | The data address received in the query is outside the initialized memory area |
| 03 | Illegal data value | The parameter data in the request is outside it's valid range. |

Table R4.2 Supported Modbus Exceptions

Multi-Word Format

The Modbus protocol uses 16 bit registers, which limits the range of values from -32,768 to 32,767 or 0 to 65,535. Many parameters and data values from the NR60E2 exceed this range. These parameters are transmitted as 32-bit values in two separate registers with little endian format. The table below shows how values are split.

| Value | First Register | Second Register |
|----------------------------|--------------------|-----------------|
| 12 (0x0000 000C) | 12 (0x000C) | 0 (0x0000) |
| 1,234,567 (0x0012 D687) | 54,919 (0xD687) | 18 (0x0012) |

Table R4.3 Multi-Word Format Examples

Output Data Format

Table R4.4 shows the correct format for the Network Output Registers that configure the NR60E2. On power up, the NR60E2 writes the current configuration to these registers. The current configuration can be retrieved by reading these words. The configuration can be changed by writing to these words. Presetting the position or saving the configuration to flash memory requires state changes on bits in the Command Word. All other data is acted on as soon as it is accepted. (Invalid data values are rejected by the NR60E2.)

| Register | Description | Example |
|----------|--|-----------------------|
| 1024 | Command Word | See Description below |
| 1025 | Preset Value: The value that you want the position to become when you issue this command. The Preset Value can be any number between 0 and the maximum count of the encoder. The values on the right show the register values in hexadecimal if the Preset Value is 704,303 (0x 000A BF2F) | 0xBF2F |
| 1026 | | 0x000A |
| 1027 | Configuration Word | See Description Below |
| 1028 | Counts per Turn: Sets the number of counts generated over a single turn if the Scaling Function Control parameter equals "1". This value requires two registers and ranges from 2 to 65,536. A value of 39,370 (16#99CA) is shown to the right.) | 0x99CA |
| 1029 | | 0x0000 |
| 1030 | Velocity Format: Format of the velocity data. 0x1F04 (7,940) for pulses/second, 0x1F05 (7,941) for pulses/millisecond, 0x1F07 (7,943) for pulses/minute or 0x1F0F (7,951) for revolutions/minute. The value of "1F04" to the right would set the unit of measure to pulses/second. | 0x1F04 |
| 1031 | Total Measurement Range: Sets the number of counts before the position value returns to zero. If this parameter is left at its default value of zero, the roll over position is determined by the <i>Measuring Units per Span</i> parameter and the number of turns the NR60E2 can encode. The Total Measurement Range can be any number between 0 and the maximum count of the encoder. The values on the right show the register values in hexadecimal if the Total Measurement Range is 8,073,859 (0x 007B 3283) | 0x3283 |
| 1032 | | 0x007B |

Table R4.4 Output Registers Data Format

Output Data Format (continued)

Command Word

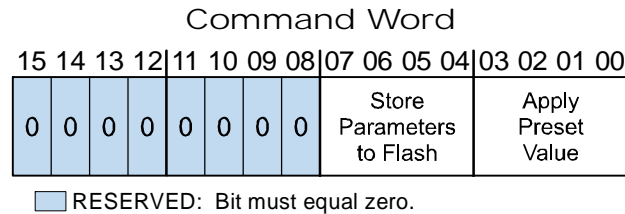

Figure R4.2 Command Word Format

Apply Preset Value: These four bits control when the Preset Value in registers 1025 and 1026 is applied to the position value. In order for the position to be preset, the value in these four bits must *transition* from 0x2 (0b0010), to 0xD (0b1101). When these four bits make this transition, the NR60E2 calculates the position offset needed to bring the position to the Preset Value.

NOTE 

- 1) The minimum time between writes to the NR60E2 is one millisecond. (The NR60E2 reads the input data every millisecond.) If the 0x2 or 0xD values are updated faster than 1 millisecond, the NR60E2 may not catch the transitions on the proper bits.
- 2) When the Total Measurement Range parameter is changed, the Preset Value is not reset to zero. Therefore it is possible to have a Preset Value in registers 1025/1026 that is greater than the Total Measurement Range parameter in registers 1031/1032. If you attempt to apply a Preset Value that is greater than the Total Measurement Range, the NR60E2 will respond with a Modbus Exception Code 3 when it senses the 0x2 to 0xD transition on the Command Word. It will leave the reported position value unchanged.

Store Parameter to Flash: These four bits control when the programmable parameters are stored to non-volatile memory. These values are not automatically written to this memory whenever they are changed. In order to store these parameter values, these four bits must *transition* from 0x2 (0b0010), to 0xD (0b1101). Note that these bits are in locations 04 - 07. The actual register values when issuing this command are 0x20 and 0xD0.

NOTE 

Setting the *Total Measurement Range* parameter to a non-zero value will force the NR60E2 to automatically store the internal position offset to non-volatile memory. If the *Total Measurement Range* parameter equals zero, the internal position offset is stored to non-volatile memory along with the programmable parameters when a Store Parameter to Flash command is issued. Therefore, if the *Total Measurement Range* parameter equals zero and you preset the position, the calculated internal offset is reset to the last value stored in non-volatile memory when you cycle power.

Output Data Format (continued)

Configuration Word

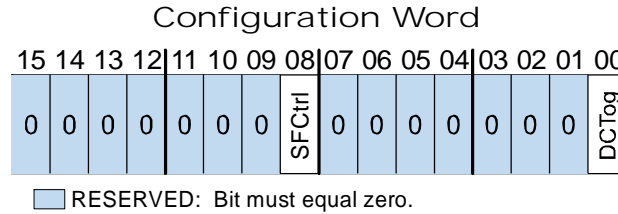

Figure R4.3 Configuration Word Format

- DCTog:** Direction Control Toggle bit. When this bit equals “0”, the position value will increase with clockwise rotation when looking at the front of the shaft. When this bit equals “1” the position value will increase with counter-clockwise rotation when looking at the front of the shaft.
- SFCtrl:** Scaling Function Control bit. When this bit equals “0”, the position resolution will be 65,536 counts per turn. When this bit equals “1”, the position resolution will be set by the Measuring Units per Span parameter value contained in registers 1028 and 1029. The *Total Measurement Range* parameter is not affected by the state of the *Scaling Function Control* bit.

Input Data Format

Table R4.5 shows the format of the data that can be read from the NR60E2. Both are 32 bit values that use the little endian format.

| Register | Data Value | Example |
|----------|---|---------|
| 0 | 32 bit Scaled Position Value. This data is the calculated position data. Its value is affected by the Measuring Units per Span parameter if the Scaling Function Control bit equals “1”. This value can also be preset to any value within its range by using the Apply Preset Value command. The lower 16 bits of this value are in register 0. A Position Value of 84,742,977 (0x050D 1341) is shown as an example. | 0x1341 |
| 1 | | 0x050D |
| 2 | 32 bit Velocity data. This data is the calculated change in position over time. The unit of measure is set with the Velocity Format parameter. If the Scaling Function Control bit is ever set to a “1”, the position data used to calculate the velocity data is always scaled by the Measuring Units per Span parameter. The lower 16 bits of this value are in register 2. A Velocity reading of 76,754 (0x0001 2BD2) is shown as an example. | 0x2BD2 |
| 3 | | 0x0001 |

Table R4.5 Modbus Input Data Format

PROFINET PARAMETERS

PROFINET Parameter Names

The following section introduces the additional parameters and name changes that are defined by the PROFINET specification.

Compatibility Mode

This parameter is used to configure the NR60E2 to be compatible with V3.1 of the encoder profile. When set to its enabled state, the NR60E2 acts as a V3.1 encoder. The *Control by PLC / Control Requested* handshake protocol is not used and the Alarm Channel Control and Tolerated Sign-of-Life Faults parameters are enabled.

Class 4 Functionality

This parameter selectively enables or disables Class 4 functionality. When set to “0”, the Code Sequence, Scaling Function Control, and Preset parameters are forced into their disabled states. When these parameters are disabled, position values will increase with CW rotation and the NR60E2 will report position and velocity at their maximum resolution of 65,536 counts per turn. Position values will be reported at the maximum number of turns supported by the NR60E2.

Code Sequence

Code Sequence is the term used by the PROFINET specification for the Count Direction parameter. This parameter allows you to set the direction of shaft rotation needed to produce increasing counts. The default is CW when looking at the shaft. This parameter is ignored when the Class 4 Functionality parameter is set to its disabled state and CW rotation will produce increasing counts.

Scaling Function Control

NOTE  The name and functionality of this parameter does not change, however, this parameter is forced into its disabled state when the Class 4 Functionality parameter is set to its disabled state. Therefore, if the Class 4 Functionality parameter is set to its disabled state, the Scaling Function Control, MUR, and TMR parameters are ignored and the NR60E2 reports position at its maximum resolution and number of turns.

Measurements Units per Revolution

Measurements Units per Revolution (MUR) is the term used by the PROFINET specification for the Counts Per Turn parameter.

Preset Control - G1_XIST1

This parameter determines if the position value reported in the network data as signal G1_XIST1 can be preset or offset using network commands. G1_XIST2 and G1_XIST3 can always be preset or offset.

- A value of “0” disables presetting G1_XIST1.
- A value of “1” enables presetting G1_XIST1.

NOTE  This parameter is only used if the *Class 4 Functionality* parameter is set to its enabled state. If the *Class 4 Functionality* parameter is set to its disabled state, none of the three position signals can be preset.

Alarm Channel Control

This parameter is only used when the NR60E2 has its Compatibility Mode parameter enabled. (The NR60E2 is configured as a version 3.1 encoder.) This parameter controls the amount of data sent over the alarm channel. When reset to “0”, only communication related alarms are sent via the alarm channel. When set to “1”, encoder specific faults are also sent via the alarm channel.

PROFINET Parameter Names (continued)

Sign-of-Life Failures

This parameter is only used when the NR60E2 has its Compatibility Mode parameter set to its enabled state. (The NR60E2 is configured as a version 3.1 encoder.) This parameter sets the number of failures in the master’s sign-of-life signal that will be tolerated before an error is issued. Range of values is 1 to 255. If the Compatibility Mode parameter is set to its disabled state, (the NR60E2 is configured to be a V4.1 encoder), this parameter is ignored and the NR60E2 will issue an error after one failure.

Factory Default Settings

The factory default settings for the NR60E2 are given in the table below.

| Parameter | Setting |
|-----------------------------------|---|
| Webserver IP Address | 192.168.0.50 |
| Network Subnet Mask | 255.255.255.0 |
| Default Gateway | 192.168.0.1 |
| V3.1 Compatibility Mode | Disabled |
| Encoder Class 4 Functionality | Enabled |
| Alarm Channel Control | Disabled. Not applicable with default settings. |
| Tolerated Sign-of-Life Faults | 1. Cannot be changed with default settings. |
| Scaling Function Control | Disabled |
| G1_XIST1 Preset Control | Disabled |
| Code Sequence | CW |
| Measurements Units per Revolution | 65,536 |
| Total Measurement Range | 16-bit NR60E2: 65,536 28-bit NR60E2: 268,435,456 30-bit NR60E2: 1,073,741,824 |
| Velocity Format | counts/second |
| Internal Position Offset | 0 |

Table R5.1 Factory Default Settings

If you do not know the IP address used by the NR60E2 for its webserver, you can set the IP Address Switches to a value of 999 and apply power to the NR60E2. The NR60E2 will use the default network address listed above when the IP Address Switches to 999. See *IP Address Switches* found on page 13 for more information.

PROFINET ACYCLIC DATA FORMATS

Acyclic Data

The NR60E2 provides acyclic data for non-real time readout of the device configuration as well as setting the preset/offset value that is applied using cyclic data in the supported standard telegrams.

With the use of the GSDML file for the NR60E2, most of these settings are available as device parameters in your programming software. They can also be programmatically accessed using the listed parameter values.

I&M Function

The Identification & Maintenance (I&M) function is available via record index 0xAFF0. The NR60E2 only supports module 0, (I&M0). Access to this function is read only.

| Description | # of bytes |
|-----------------------------|------------|
| Blockheader | 6 |
| Manufacturer ID (Vendor ID) | 6 |
| Order ID | 20 |
| Serial Number | 16 |
| Hardware Revision | 2 |
| Software Revision | 4 |
| Revision Counter | 2 |
| Profile ID (API) | 2 |
| Profile Specific Type | 2 |
| IM Version | 2 |
| IM Supported | 2 |

Table R6.1 I&M0 Data Format

P922 - Telegram Selection

This parameter is equal to the telegram number that is currently in use for cyclic data exchange.

- Read-only
- Unsigned16 Integer
- Range of Values: 81, 82, 83, 84, 860

P925 - Maximum life sign failures that may be tolerated

This parameter sets the number of Sign-of-Life signal faults before a fault is issued. This parameter is only used when Compatibility mode is enabled. (Profile version 3.1) If Compatibility mode is disabled, (profile version 4.1), only one Sign-Of-Life fault is tolerated.

- Read/Write
- Unsigned16 Integer
- Range of Values: 1 to 254, 255 = Sign-of-Life not monitored.

P964 - Device Identification

This parameter returns an array of values that identifies the NR60E2.

- Read-only
- Array [0..5] of Unsigned16 Integer

| Index | Sub | Meaning | Value | Access |
|-------|-----|---|--------------------|--------|
| 964 | 0 | Manufacturer ID (Vendor ID assigned by PI) | 0x0402 | RO |
| 964 | 1 | DU Drive unit type (Vendor specific) | 1 | RO |
| 964 | 2 | Software version | xxxx ¹ | RO |
| 964 | 3 | Software year | yyyy ² | RO |
| 964 | 4 | Software day and month | dd.mm ³ | RO |
| 964 | 5 | Number of Drive Object (DO) | 1 | RO |

- 1) xxxx = 118 at time of manual release
- 2) yyyy = 2018 at time of manual release
- 3) dd.mm = 101 (January 1st) at time of manual release

Table R6.2 P964 - Device ID parameter values

P965 - Profile Identification

This parameter array returns the encoder profile number, and the profile version the NR60E2 is configured for.

- Read-only
- Array [0..1] of Octet String

| Index | Sub | Meaning | Value | Access |
|-------|-----|----------------------------------|----------|--------|
| 965 | 0 | Profile number | 0x3D | RO |
| 965 | 1 | Profile version, set by customer | 31 or 41 | RO |

Table R6.3 P965 - Device ID parameter values

P971 - Store local parameters to non-volatile memory

This read/write parameter is used to store local parameters to non-volatile memory. A 0→1 transition on this bit signals the NR60E2 to store its parameters to non-volatile memory. The NR60E2 will respond by resetting this bit to a zero when the write is completed.

- Read/Write
- Unsigned16 Integer
- Range of Values: 0, 1

P974 - Base Mode Parameter Access Service Identification

This parameter is an array of values that identifies the maximum response size and the number of parameters that can be returned by the NR60E2 at one time.

- Read-only
- Array [0..2] of Unsigned16 Integer

| Index | Sub | Meaning | Value | Access |
|-------|-----|---|-------|--------|
| 974 | 0 | Maximum Block Length | 70 | RO |
| 974 | 1 | Maximum number of parameters requested at one time | 1 | RO |
| 974 | 2 | Maximum latency per request. (0 = no specification available) | 0 | RO |

Table R6.4 P974 - Base Mode Parameter Access

P975 - DO Identification

This parameter is an array of values that identifies the NR60E2 in a PROFIdrive environment.

- Read-only
- Array [0..7] of Unsigned16 Integer

| Index | Sub | Meaning | Value | Access |
|-------|-----|---------------------------------|--------|--------|
| 975 | 0 | Manufacturer ID | 0x402 | RO |
| 975 | 1 | DO Type | 1 | RO |
| 975 | 2 | Software revision | xxxx | RO |
| 975 | 3 | Software Year | yyyy | RO |
| 975 | 4 | Software day and month | dd.mm | RO |
| 975 | 5 | PROFIdrive DO classification | 0x05 | RO |
| 975 | 6 | PROFIdrive DO subclassification | 0x4000 | RO |
| 975 | 7 | Drive object ID (DO ID) | 0x01 | RO |

Table R6.5 P975 - DO Identification

P979 - Sensor Format

This parameter is an array of values that contains important properties of the NR60E2.

- Read-only
- Array [0..5] of Unsigned32 Integer

| Index | Sub | Meaning | Value | Access |
|-------|-----|-------------------------|--|--------|
| 979 | 0 | Header | 0x5011 | RO |
| 979 | 1 | DO Type | 0x8000 | RO |
| 979 | 2 | Sensor Resolution | 65,536 | RO |
| 979 | 3 | G1_XIST1 shift factor | 0 | RO |
| 979 | 4 | G1_XIST2 shift factor | 0 | RO |
| 979 | 5 | Determinable Resolution | 0, 4096, or 16,384 Value dependent on NR60E2 Number of Turns | RO |

Table R6.6 P979 - Sensor Format

P980 - Number List of Defined Parameters

This parameter is an array of values that lists the parameter numbers of parameters available on the NR60E2.

- Array [0..9] of Unsigned16 Integer

| Index | Sub | Meaning | Value | Access |
|-------|-----|--|-------|--------|
| 980 | 0 | P922 - Telegram Selection | 922 | RO |
| 980 | 1 | P925 - Maximum life sign failures that may be tolerated | 925 | RO |
| 980 | 2 | P964 - Device Identification | 964 | RO |
| 980 | 3 | P965 - Profile Identification | 965 | RO |
| 980 | 4 | P971 - Store local parameters to non-volatile memory | 971 | RO |
| 980 | 5 | P974 - Base Mode Parameter Access Service Identification | 974 | RO |
| 980 | 6 | P975 - DO Identification | 975 | RO |
| 980 | 7 | P979 - Sensor Format | 979 | RO |
| 980 | 8 | P65000 - Preset Value | 65000 | RO |
| 980 | 9 | P65001 - Operating Status | 65001 | RO |

Table R6.7 P980 - Number of Defined Parameters

P65000 - Preset Value

This read / write parameter sets the preset/offset value associated with the NR60E2. A handshake protocol in the cyclic data controls when this parameter is applied to the position value reported by the NR60E2.

- Read/Write
- Unsigned32 Integer
- Range: 0 to {Total Measurement Range (TMR) - 1}.

P65001 - Operating Status

This parameter is an array where information on the operating status of the encoder can be found.

- Array [0..10] of Unsigned32 Integer

| Index | Sub | Meaning | Value | Access |
|-------|-----|--------------------------------------|--------------------------------|--------|
| 65001 | 0 | Header | 0x000C0101 | RO |
| 65001 | 1 | Operating Status | See R6.1 below | RO |
| 65001 | 2 | Faults | See R6.2 below | RO |
| 65001 | 3 | Supported Faults | 0x00000031 (See R6.2 below) | RO |
| 65001 | 4 | Warnings | 0x0 ¹ | RO |
| 65001 | 5 | Supported Warnings | 0x0 ¹ | RO |
| 65001 | 6 | Encoder profile version | 0x00000401 | RO |
| 65001 | 7 | Operating Time | 0xFFFFFFFF | RO |
| 65001 | 8 | Offset Values (G1_XIST1) | variable | RO |
| 65001 | 9 | Measuring Units per Revolution (MUR) | variable | RO |
| 65001 | 10 | Total measurement Range (TMR) | variable | RO |
| 65001 | 11 | Velocity measuring unit | variable | RO |

1) Warnings are not supported by the NR60E2.

Table R6.8 P65001 - Operating Status

P65001[1] - Operating Status

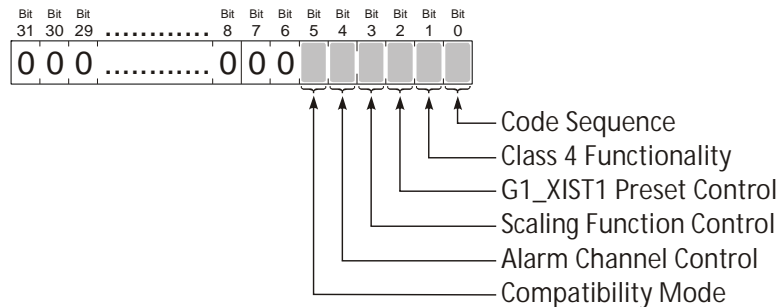

Figure R6.1 Operating Status Bit Values

Bit 0: Code Sequence – This bit, along with bit 1, *Class 4 Functionality*, can be used to determine the direction of rotation for increasing counts.

| Bit 1 | Bit 0 | Meaning |
|-------|-------|--|
| 0 | 0 | Functionality disabled, CW increasing counts |
| 0 | 1 | Functionality disabled, CW increasing counts |
| 1 | 0 | CW increasing counts |
| 1 | 1 | CCW increasing counts |

Bit 1: Class 4 Functionality – If this bit equals “0”, the Code Sequence, G1_XIST1 Preset Control, and Scaling Function Control functionality is disabled.

P65001 - Operating Status (continued)

P65001[1] - Operating Status (continued)

Bit 2: G1_XIST1 Preset Control – This bit, along with bit 1, *Class 4 Functionality*, can be used to determine if the position value reported in the G1_XIST1 signal can be preset or offset.

| Bit 1 | Bit 2 | Meaning |
|-------|-------|---|
| 0 | 0 | Functionality disabled, G1_XIST1 cannot be preset/offset. |
| 0 | 1 | Functionality disabled, G1_XIST1 cannot be preset/offset. |
| 1 | 0 | G1_XIST1 can be preset/offset. |
| 1 | 1 | G1_XIST1 cannot be preset/offset. |

Bit 3: Scaling Function Control – This bit, along with bit 1, *Class 4 Functionality*, can be used to determine if the position value reported by the NR60E2 can be scaled.

| Bit 1 | Bit 3 | Meaning |
|-------|-------|--|
| 0 | 0 | Functionality disabled, the position value cannot be scaled. |
| 0 | 1 | Functionality disabled, the position value cannot be scaled. |
| 1 | 0 | The position value cannot be scaled. |
| 1 | 1 | The position value can be scaled. |

Bit 4: Alarm Channel Control – If this bit equals “0”, only communication related alarms are sent via the alarm channel. If this bit equals “1”, encoder specific faults are also sent via the alarm channel.

Bit 5: Compatibility Mode – If this bit equals “0”, the present configuration of the NR60E2 is compatible with Encoder profile V3.1. If this bit equals “1”, the present configuration of the NR60E2 is not compatible with Encoder profile V3.1.

P65001[2,3] - Supported Faults

The following figure shows the faults supported by the NR60E2. These bits are always set in P65001[3] to indicate that the faults are supported. The corresponding bits in P65001[2] are set when a fault is occurring.

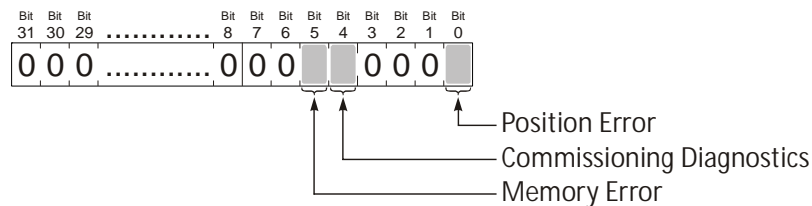

Figure R6.2 Fault Bit Values

This reference chapter lists the formats of the cyclic data signals transmitted to and from the NR60E2. This chapter also lists the five PROFINET telegrams supported by the NR60E2 that use these data formats. Telegrams are well defined data packets that are transferred between the Controller and the NR60E2.

Sensor Control Word (G1_STW)

G1_STW is one of the two control words cyclically written to the NR60E2. Only bits 15 through 11 are used by the NR60E2.

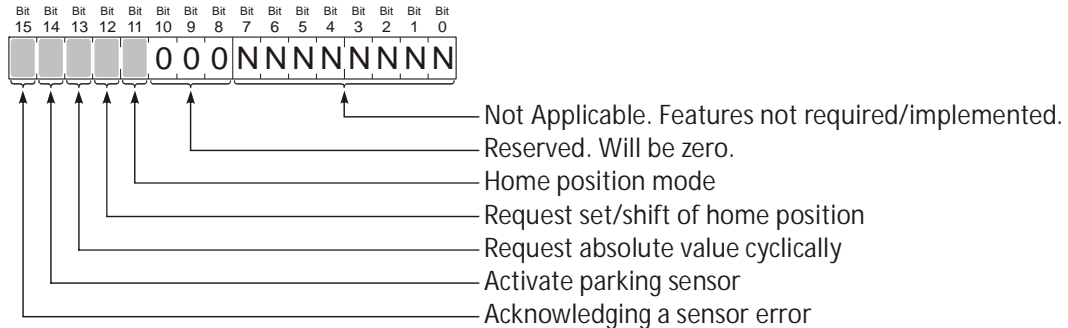

Figure R7.1 G1_STW Format

- Bit 11: Home position mode** – This bit is used in conjunction with bit 12, *Request set/shift of home position*. A 0→1 transition on bit 12 initiates a preset/offset of the current position value. In PROFINET documentation, a preset is known as an Absolute Preset, and an offset is known as a Relative Preset. The preset/offset value is named “Preset Value” and is programmed with an acyclic data transfer as parameter 65000. When this bit equals zero, the parameter is treated as a preset value, and the internal position offset is modified to bring the current position value to the preset value. When this bit equals one, the parameter is treated as an offset value, and this value is added to the internal position offset. In this case, the new position value is offset from its old position value by the value stored in the Preset Value parameter.
- Bit 12: Request set/shift of home position** – This bit is used in conjunction with bit 11, *Home position mode*. A 0→1 transition on this bit initiates a preset/offset of the current position value. The preset/offset value is named “Preset Value” and is programmed with an acyclic data transfer as parameter 65000. The state of bit 11 determines how the Preset Value is applied to the present position. This bit should remain set until the NR60E2 responds by setting G1_ZSW.12 to a “1” to signal that the position has been successfully preset or offset.
- Bit 13: Request absolute value cyclically** – When this bit is set to “1”, the G1_XIST2 signal will transmit the absolute position value unless an error condition exists. If this bit is reset to “0”, the G1_XIST2 signal will transmit a value of zero unless an error condition exists.
- Bit 14: Activate parking sensor** – When this bit is set to “1”, the NR60E2 enters the parked state. G1_XIST1 values must not be considered valid while the NR60E2 is parked. All actual errors and all error messages are cleared while the NR60E2 is parked and removing the NR60E2 from the network will not cause an alarm in the PLC controller.
- Bit 15: Acknowledging a sensor error** – This bit is a handshake response from controller. The controller must set this bit to “1” to acknowledge the *Requirement of error acknowledgement detected* bit from the NR60E2. (G1_ZSW.11) The NR60E2 will respond by resetting the *Requirement of error acknowledgement detected* bit. The sensor error bit, G1_ZSW.15, will remain active as long as an error exists.

Encoder Control Word (STW2_ENC)

STW2_ENC is one of the two control words cyclically written to the NR60E2. Only bits 15 through 12, and 10, are used by the NR60E2.

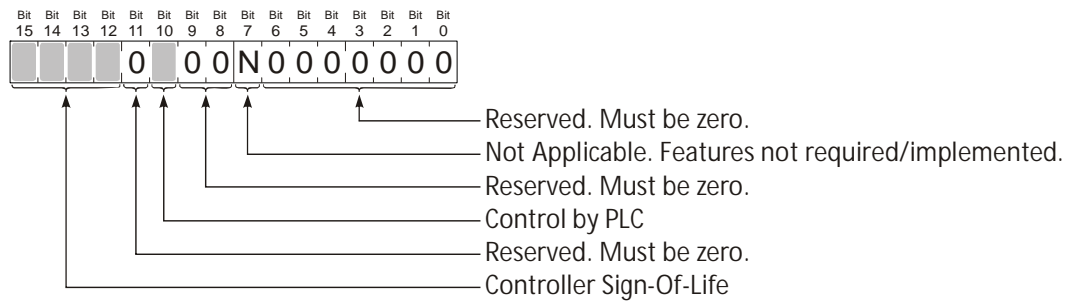

Figure R7.2 G1_STW Format

Bits 15-12: Controller Sign-of-Life – These bits are used by the NR60E2 to ensure stable communications between the NR60E2 and the controller.

Bit 10: Control by PLC – This bit is a handshake response to the *Control Requested* bit from the NR60E2. (ZSW2_ENC.9, see below.) It is a signal to the NR60E2 that data being sent to it by the controller is valid.

NOTE The *Control Requested / Control by PLC* mechanism is only used when Compatibility Mode is disabled. (The NR60E2 is configured as a V4.1 encoder.) When in Compatibility Mode and the NR60E2 is acting as a V3.1 encoder, and this functionality is ignored and the NR60E2 will always respond to data from the controller.

Sensor Status Word (G1_ZSW)

G1_ZSW is one of two control words cyclically written from the NR60E2 to the controller. Only bits 15 through 11 are used by the NR60E2.

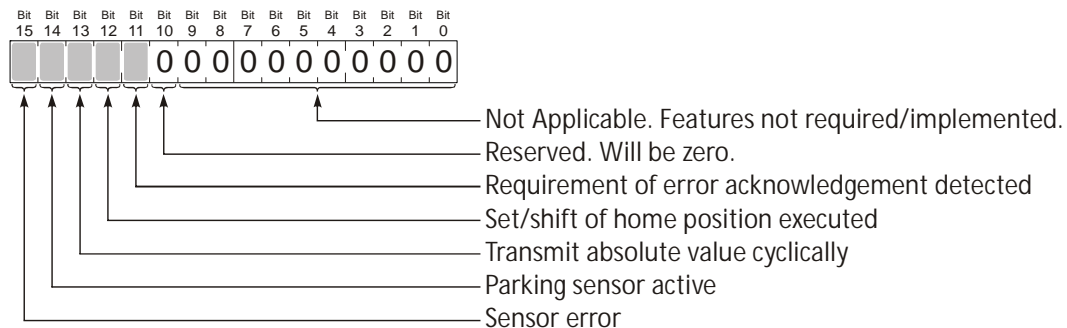

Figure R7.3 G1_ZSW Format

Bit 11: Requirement of error acknowledgement detected – This bit is used to initiate a handshake with the controller to ensure that an error signal from the NR60E2 is recognized and acknowledged. The controller must set the *Acknowledging a sensor error* bit, G1_STW.15, to acknowledge the error signal. The NR60E2 will respond by resetting the *Requirement of error acknowledgement detected* bit. The sensor error bit, G1_ZSW.15, will remain active as long as an error exists.

Bit 12: Set/shift of home position executed – This bit is used in conjunction with *Request set/shift of Home position*, G1_STW.12. A 0→1 transition on this bit indicates that the NR60E2 has successfully applied the requested preset/offset of the current position.

Bit 13: Transmit absolute value cyclically – When this bit is set to “1”, the G1_XIST2 signal contains the absolute position value. If this bit is reset to “0”, the G1_XIST2 signal is either an error code, or zero. If the G1_XIST2 signal contains an error code, G1_ZSW.15 will be set to “1”.

Sensor Status Word (G1_ZSW) (continued)

Bit 14: Parking sensor active – When this bit is set to “1”, the NR60E2 is in its parked state. The NR60E2 enters this state for one of two reasons. First, the NR60E2 is initializing and not yet ready to transmit valid data. Second, the controller has commanded a switch to the parked state by setting the *Activate parking sensor* bit, G1_STW.14, and the NR60E2 is responding to this command.

Bit 15: Sensor error – This bit is set by the NR60E2 as long as there is a sensor error. The error code is available in G1_XIST2.

Encoder Status Word 2 (ZSW2_ENC)

ZSW2_ENC is one of two control words cyclically written from the NR60E2 to the controller. Only bits 15 through 12, 9, 7, and 3 are used by the NR60E2.

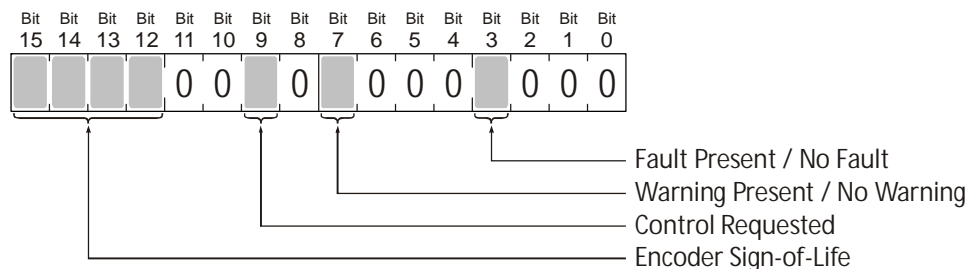

Figure R7.4 G1_ZSW Format

- Bit 3: Fault Present / No Fault** – This bit is set to ‘1’ when at least one fault is present or active in the Encoder Object. This bit is set to ‘0’ when the NR60E2 is operating without a fault. Faults are reported in P65001[2]. (See [P65001\[2,3\] - Supported Faults](#) on page 82 for a list of the supported faults.) During a fault condition, actual values reported by the NR60E2 should be considered invalid.
- Bit 7: Warning Present / No Warning** – The NR60E2 does not support warnings, because errors in the device must be considered Faults. (Errors in the NR60E2 potentially leave reported values in an invalid state, therefore errors must be considered Faults.) Therefore, this bit will always equal ‘0’.
- Bit 9: Control Requested** – When set to ‘1’, the NR60E2 is requesting that the automation system assume control of the device. When set to ‘0’, control of the NR60E2 by the automation system is not possible.
- Bits 12-15: Encoder Sign-of-Life** – These bits are not implemented by the NR60E2. These bits are mandatory only for Class 4 of the PROFINET Profile 4.1 (PROFIDRIVE Requirements), and the NR60E2 does not fully support Class 4.

Position Data Formats

The NR60E2 uses the G1_XIST1, G1_XIST2, and G1_XIST3 signals to transmit position data. The data formats are shown as right-aligned. This implies that parameters 979.3 and 979.4, the “Shift factors” for G1_XIST1 and G1_XIST2, are both equal to 0. The NR60E2 is an absolute encoder that does not offer signal period interpolation. If p979.3 or p979.4 are non-zero, the NR60E2 will transmit zeros in the least significant bits of the position data. The formats below assume the NR60E2 is configured for its maximum resolution and maximum number of turns.

G1_XIST1 and G1_XIST3

The G1_XIST1 and G1_XIST3 signals will contain the absolute position from the NR60E2 under normal conditions. It is a thirty-two bit value. By default, the G1_XIST1 is right aligned. (p979.3 equals zero.) The G1_XIST3 is always right aligned. The figure below shows the maximum number of bits used. In the G1_XIST3 signal, bits 63 through 32 are always zero. The programmed Measuring Units per Revolution (MUR) and Total Measurement Range (TMR) parameters will affect the number of bits used.

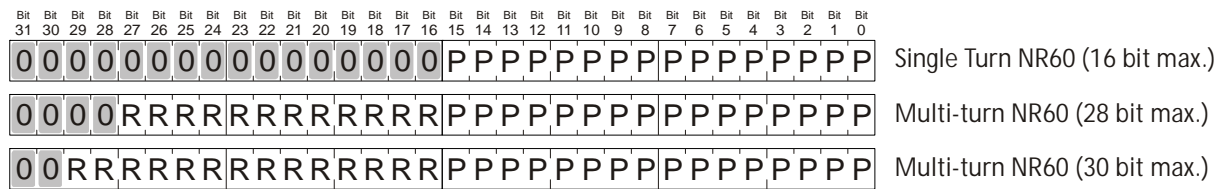

“P” = Position within Turn “R” = Number of Revolutions

Figure R7.5 G1_XIST1 Data Format

G1_XIST2

If G1_STW.13, *Request absolute value cyclically*, is set to “1”, G1_XIST2 transmits the absolute position value of the NR60E2, under normal operating conditions. The position is a thirty-two bit value. By default, it is right aligned. (p979.4 equals zero.) The figure below shows the maximum number of bits used. The programmed Measuring Units per Revolution (MUR) and Total Measurement Range (TMR) parameters will affect the number of bits used. If there is a sensor error, the NR60E2 will report a diagnostic code in G1_XIST2. The G1_ZSW status word contains the bits that specify the data transmitted in G1_XIST2.



Bits in G1_ZSW determine the value in G1_XIST2
 If G1_ZSW.13 = 1, G1_XIST2 is the absolute position of the NR60.
 If G1_ZSW.15 = 1, G1_XIST2 is an error code from the NR60.
 If G1_ZSW.13 = G1_ZSW.15 = 0, data in G1_XIST2 is invalid.

Figure R7.6 G1_XIST2 Data Format

Velocity Data Format

The NR60E2 uses the NIST_A and NIST_B signals to transmit velocity data. The NIST_A signal has a sixteen bit format and the NIST_B signal has a thirty-two bit format. Both signals are right aligned.

Standard Telegram 81

Standard Telegram 81 uses four bytes of output data (IO Controller → NR60E2), and twelve bytes of input data (NR60E2 → I/O Controller).

Output Data

| | PROFINET Data Name | |
|------------------|----------------------|---------------------|
| | STW2_ENC | G1_STW |
| Data Word Length | 2 bytes | 2 bytes |
| Description | Encoder Control Word | Sensor Control Word |

Table R7.1 Telegram 81 Output Data Format

Input Data

| | PROFINET Data Name | | | |
|------------------|---------------------|--------------------|-----------------------|--------------------------------------|
| | ZSW2_ENC | G1_ZSW | G1_XIST1 | G1_XIST2 |
| Data Word Length | 2 bytes | 2 bytes | 4 bytes | 4 bytes |
| Description | Control Status Bits | Sensor Status Word | 32 bit Position Value | 32 bit Position Value or Error Value |

Table R7.2 Telegram 81 Input Data Format

Standard Telegram 82

Standard Telegram 82 uses four bytes of output data (IO Controller → NR60E2), and fourteen bytes of input data (NR60E2 → I/O Controller).

Output Data

| | PROFINET Data Name | |
|------------------|----------------------|---------------------|
| | STW2_ENC | G1_STW |
| Data Word Length | 2 bytes | 2 bytes |
| Description | Encoder Control Word | Sensor Control Word |

Table R7.3 Telegram 82 Output Data Format

Input Data

| | PROFINET Data Name | | | | |
|------------------|---------------------|--------------------|-----------------------|--------------------------------------|-----------------------|
| | ZSW2_ENC | G1_ZSW | G1_XIST1 | G1_XIST2 | NIST_A |
| Data Word Length | 2 bytes | 2 bytes | 4 bytes | 4 bytes | 2 bytes |
| Description | Control Status Bits | Sensor Status Word | 32 bit Position Value | 32 bit Position Value or Error Value | 16 bit Velocity Value |

Table R7.4 Telegram 82 Input Data Format

Standard Telegram 83

Standard Telegram 83 uses four bytes of output data (IO Controller → NR60E2), and sixteen bytes of input data (NR60E2 → I/O Controller).

Output Data

| | PROFINET Data Name | |
|------------------|----------------------|---------------------|
| | STW2_ENC | G1_STW |
| Data Word Length | 2 bytes | 2 bytes |
| Description | Encoder Control Word | Sensor Control Word |

Table R7.5 Telegram 83 Output Data Format

Input Data

| | PROFINET Data Name | | | | |
|------------------|---------------------|--------------------|-----------------------|--------------------------------------|-----------------------|
| | ZSW2_ENC | G1_ZSW | G1_XIST1 | G1_XIST2 | NIST_B |
| Data Word Length | 2 bytes | 2 bytes | 4 bytes | 4 bytes | 4 bytes |
| Description | Control Status Bits | Sensor Status Word | 32 bit Position Value | 32 bit Position Value or Error Value | 32 bit Velocity Value |

Table R7.6 Telegram 83 Input Data Format

Standard Telegram 84

Standard Telegram 84 uses four bytes of output data (IO Controller → NR60E2), and twenty bytes of input data (NR60E2 → I/O Controller).

Output Data

| | PROFINET Data Name | |
|------------------|----------------------|---------------------|
| | STW2_ENC | G1_STW |
| Data Word Length | 2 bytes | 2 bytes |
| Description | Encoder Control Word | Sensor Control Word |

Table R7.7 Telegram 84 Output Data Format

Input Data

| | PROFINET Data Name | | | | |
|------------------|---------------------|--------------------|-----------------------|--------------------------------------|-----------------------|
| | ZSW2_ENC | G1_ZSW | G1_XIST3 | G1_XIST2 | NIST_B |
| Data Word Length | 2 bytes | 2 bytes | 8 bytes | 4 bytes | 4 bytes |
| Description | Control Status Bits | Sensor Status Word | 64 bit Position Value | 32 bit Position Value or Error Value | 32 bit Velocity Value |

Table R7.8 Telegram 84 Input Data Format

AMCI Telegram 860

AMCI Telegram 860 uses four bytes of output data (IO Controller → NR60E2), and eight bytes of input data (NR60E2 → I/O Controller).

G1_XIST_PRESET_A

The G1_XIST_PRESET_A signal is a thirty-two bit value that is used to preset the position value of the NR60E2 using only cyclic data. A 0 → 1 transition on bit 32 of this value signals to the NR60E2 that the lower bits should be used to preset the position value. The transmitted preset value must be less than the value of the Total Measurement Range parameter.

NOTE 

- 1) This value can only be used to preset the position value. It cannot be used to offset the position value by a programmed amount.
- 2) The shaft should not be rotating when bit 32 makes a 0 → 1 transition. A position error will most likely occur if the shaft is rotating during the preset command.

Output Data

| PROFINET Data Name | |
|--------------------|---|
| G1_XIST_PRESET_A | |
| Data Word Length | 4 bytes |
| Description | Preset Position value and cyclic control bit. |

Table R7.9 Telegram 860 Output Data Format

Input Data

| PROFINET Data Name | | |
|--------------------|-----------------------|-----------------------|
| | G1_XIST1 | NIST_B |
| Data Word Length | 4 bytes | 4 bytes |
| Description | 32 bit Position Value | 32 bit Velocity Value |

Table R7.10 Telegram 860 Input Data Format

NOTE 

The Sign-of-life mechanism is not available when using telegram 860.

Notes

PROFINET NETWORK CONFIGURATION

This chapter outlines the steps commonly needed to get an NR60E2 communicating with the PROFINET master. A Siemens SIMATIC S7-1212C controller is used as an example.

Basic Steps

Configuring a PROFINET host requires a few basic steps.

- 1) Download the ZIP archive that contains the GSDML files for the NR60E2 from the www.amci.com website.
- 2) Install the GSDML file into the configuration software for your host controller.
- 3) Add the NR60E2 to the PROFINET Network.
- 4) Set the I/O word addresses used to communicate with the unit.

7.1 Download the GSDML file

The GSDML file is available on the AMCI website on the <http://www.amci.com/industrial-automation-support/configuration-files/> web page. The file is a ZIP archive that has to be extracted to a folder on your computer. Extracting the ZIP file will leave you with multiple files. One is the GSDML file and the others are icon files for the various devices.

7.2 GSDML File Installation

- 1) Open or create a new project that will include the NR60E2 and open the Project View of the project.
- 2) In the menu, select *Options* -> *Manage general station description files (GSD)*.
- 3) In the window that opens, click on the [...] button and navigate to the folder that contains the extracted GSDML file you downloaded from the AMCI website. Once at the folder, click on the [OK] button.
- 4) Click on the check box next to the name of the GSD file and click on the [Install] button. The system will install the GSD file.
- 5) Click the [Close] button and wait for the software to finish installing the file and updating the Hardware Catalog.

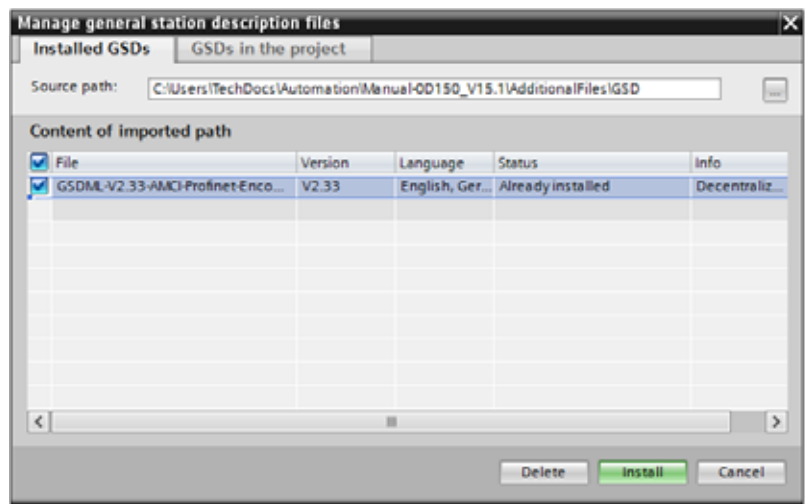

Figure T7.1 GSD File Installation

7.3 Configure the PROFINET Network

A CPU must be added to the project and the PROFINET network must be configured before an NR60E2 can be added to the system.

Refer to Siemens documentation for information on configuring the PROFINET network to suit your application.

7.4 Add the NR60E2 to the PROFINET Network

- 1) With the project open in Project View, double click on “Device & Networks” in the project tree.
- 2) If need be, click on the “Hardware Catalog” vertical tab to open the Hardware Catalog.
- 3) You can search for “NR60”, or browse to the NR60 icon by clicking through *Other field devices* +> *PROFINET IO* +> *Encoders* +> *Advanced Micro Controls Inc.* +> *Absolute Encoders* +> *Standard*. At this point, select either the *Multiturn* or the *Singleturn* branch based on your part number.
 - If your part number is NR60E2-????-2?01, select Multiturn and then the AMCI NR60-M28 icon.
 - If your part number is NR60E2-????-3?01, select Multiturn and then the AMCI NR60-M30 icon.
 - If your part number is NR60E2-????-1?01, select Singleturn and then the AMCI NR60-S16 icon.

Drag and drop the appropriate icon onto the PROFINET network.

- 4) Drag the green square on the NR60E2 icon onto the PROFINET network line, or the appropriate port on the controller, to connect the device to the correct network.

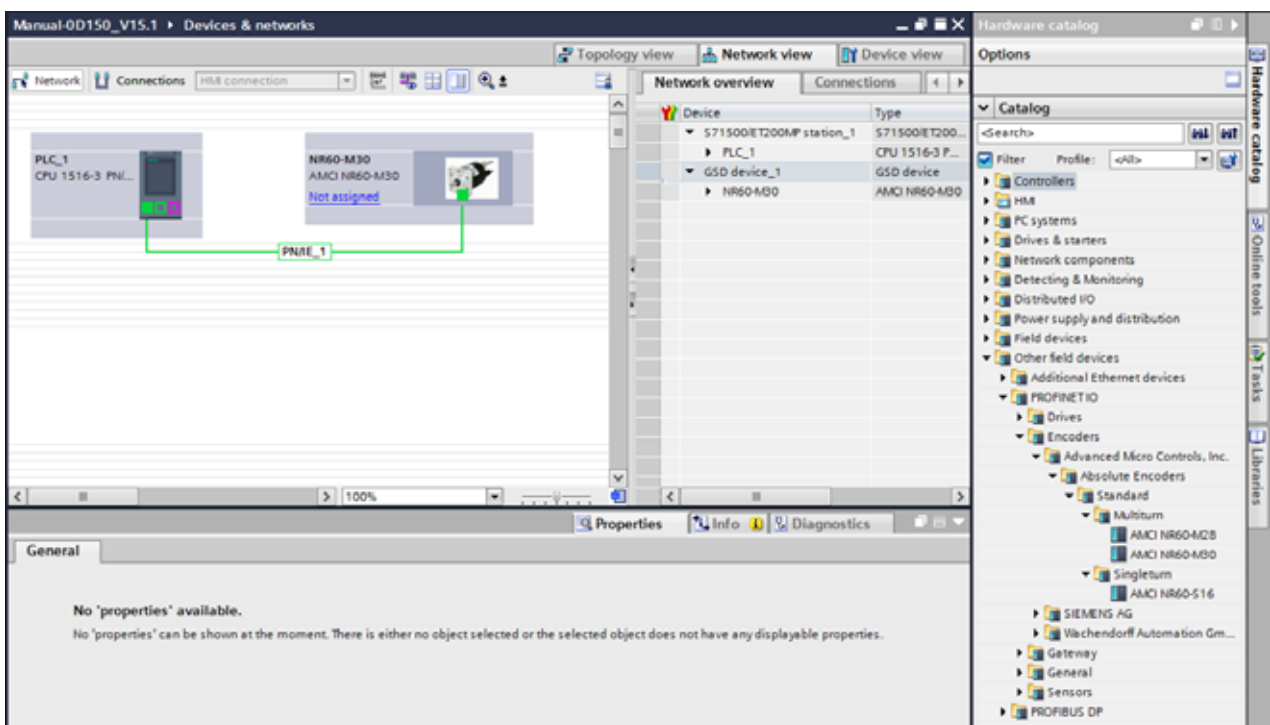

Figure T7.2 NR60E2 added to PROFINET Network

7.4 Add the NR60E2 to the PROFINET Network (continued)

- 5) Right click on the NR60E2 icon and select “Properties” from the pop up menu. The Inspector window will open at the bottom of the screen. Under the “General” tab, select the “►General” heading. You can rename the NR60E2 by changing the Name: field.
- 6) Under the “►PROFINET interface [x1]” heading, select “Ethernet addresses”. Under the IP protocol section, set the desired IP address and subnet mask for the NR60E2.

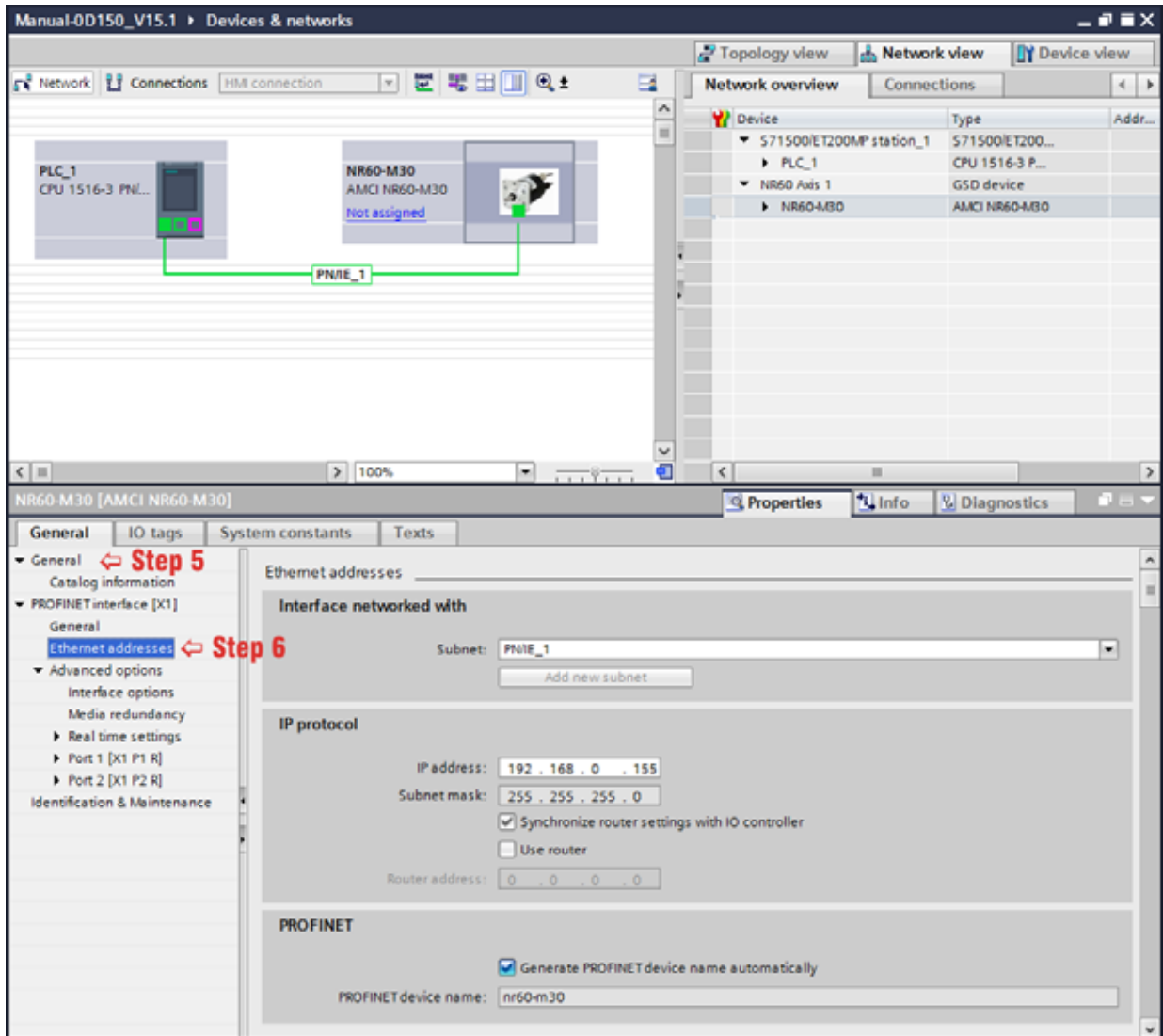

Figure T7.3 NR60E2 IP Addressing

7.5 Set the Telegram

The NR60E2 uses one of five telegrams to communicate cyclically with the controller. The format of the telegrams is explained in the *PROFINET Cyclic Data Formats* Reference chapter, starting on page 83.

With the NR60E2 icon selected on the PROFINET bus, click on the “Device view” tab. The view in the Hardware Catalog will change. Expand the Submodules tree to show the Submodules available for the NR60E2.

- 1) To map the telegram, simply drag the appropriate telegram from the hardware catalog and drop it on slot 1 2 of the NR60E2 under the Device overview tab.

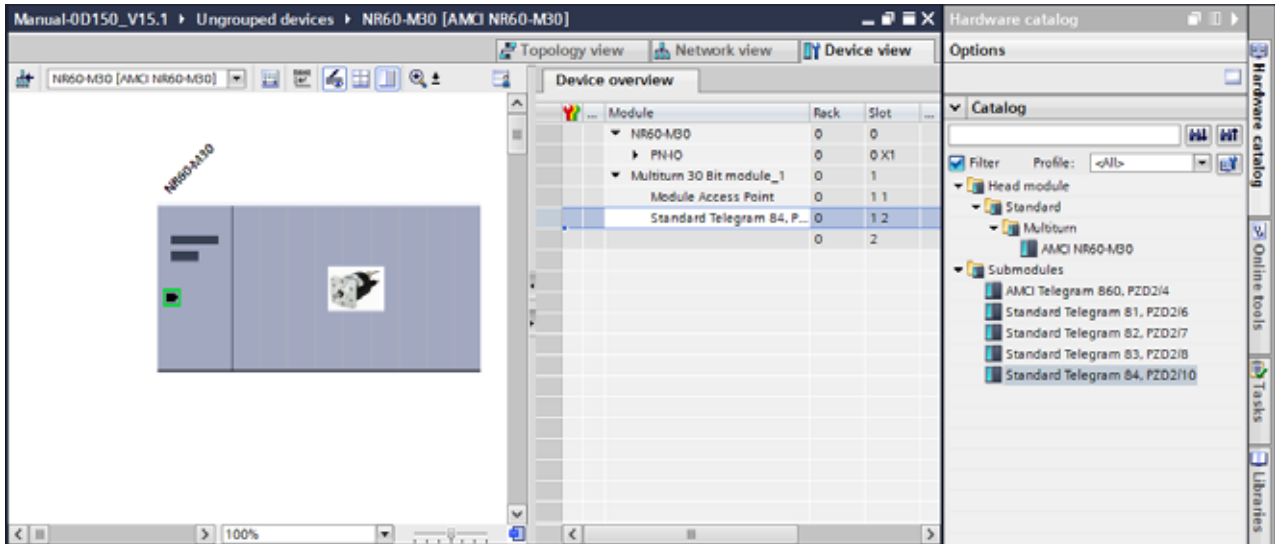

Figure T7.4 Telegram Mapping

7.6 Set the NR60E2 Parameters

The NR60E2 uses one of five telegrams to communicate cyclically with the controller. The format of the telegrams is explained in the *PROFINET Cyclic Data Formats* Reference chapter, starting on page 83.

With the NR60E2 icon selected on the PROFINET bus, click on the “Device view” tab. The view in the Hardware Catalog will change.

- 1) In the Device overview pane, right click on “Module Access Point” and select “Properties” from the resulting drop down list.
- 2) In the “Module Access Point [Module Access Point]” pane at the bottom of the screen, select “Module Parameters”. The “Standard parameters (Encoder Profile)” will appear with the parameters set to their default values. The parameter values can be changed here. The NR60E2 parameters are explained in the *Programmable Parameters* section, starting on page 15.

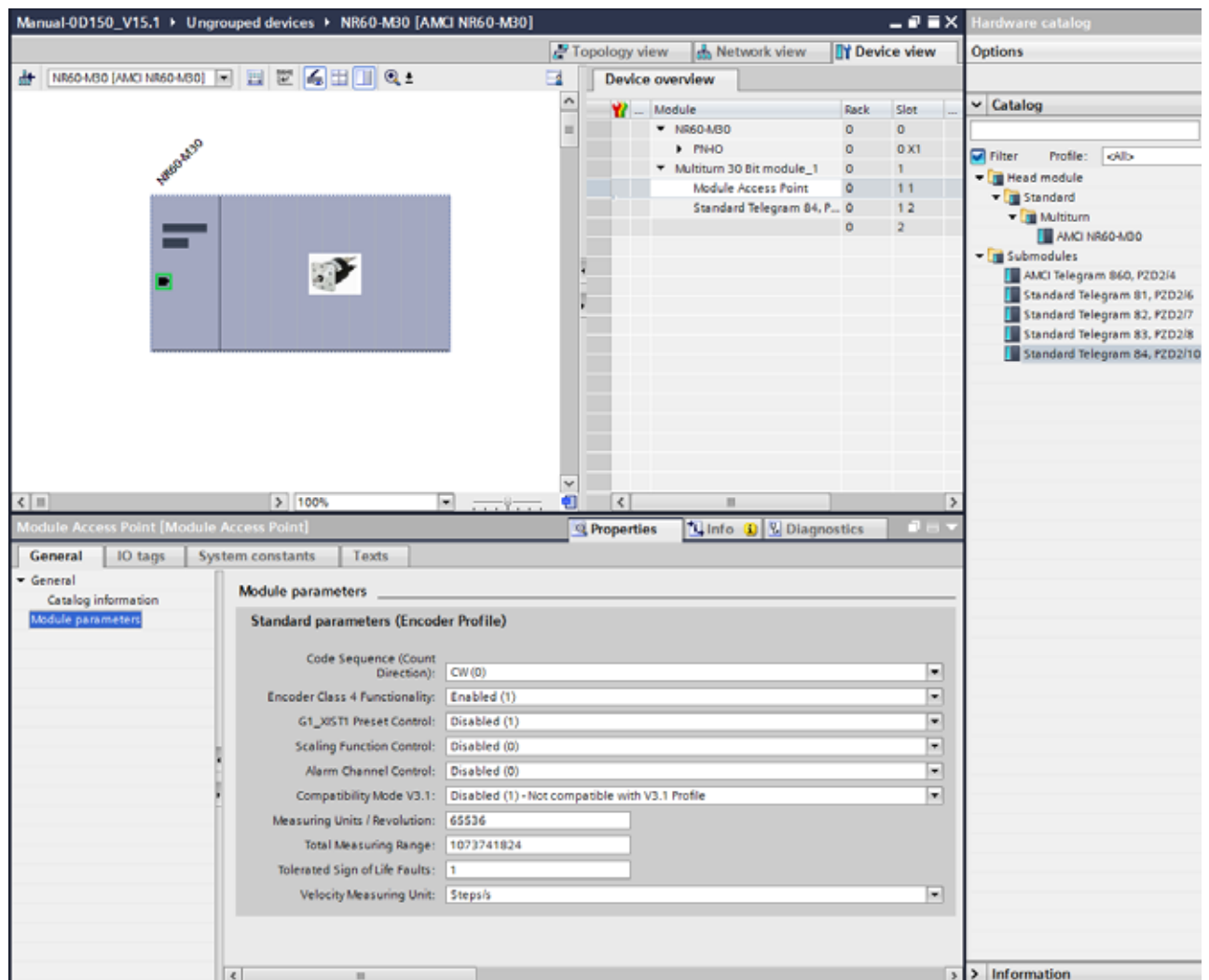

Figure T7.5 Setting NR60E2 Parameters

7.7 Set the NR60 Device Name

- 1) Right click on the NR60 icon and select “Assign device name” from the resulting popup menu.
- 2) In the “Assign PROFINET device name.” windows that appears, click on the [Update list] button.
- 3) Once the NR60 appears in the table, select the NR60 in the table.
- 4) Confirm that the “PROFINET device name:” at the top of the screen is correct.
- 5) Click on the [Assign name] button to write the device name to the NR60. The “Online status information:” table at the bottom of the screen will show that the name was successfully assigned to the MAC address of the NR60.

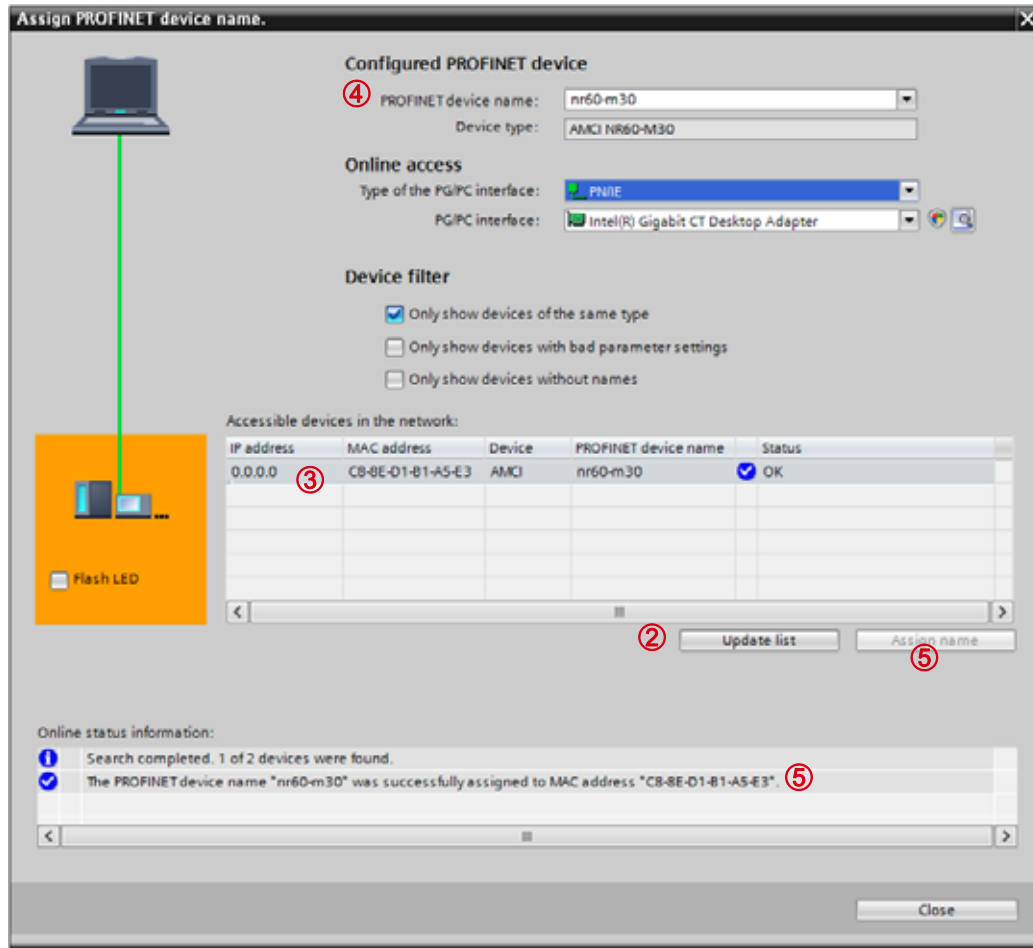

Figure T7.6 Setting NR60 Device Name

7.8 Verify and Download the New Configuration

- 1) Continue by adding any remaining devices to your PROFINET network.
- 2) Compile and download the project to the CPU.

MRP Installations

At this point, the NR60E2 is configured and ready to use. If you are using the unit in a redundant, ring based, network that uses the Media Redundancy Protocol (MRP), continue with the following instructions.

Media Redundancy Protocol (MRP) installations require that the NR60E2 be installed in a ring topology. In these applications, both Ethernet ports are used when wiring the ring, daisy chaining from one unit in the ring to the next. The steps below covers typical software configuration that must also be completed.

7.9 Configure the NR60E2 as an MRC

The NR60E2 functions as a Media Redundancy Client (MRC) in an MRP network.

- 1) Switch to Topology view and drag the additional connections between the appropriate ports.
- 2) Click on the NR60E2 icon to select it. In the Inspector window, select *Advanced options* +> *Media redundancy*. Use the “MRP domain:” drop down menu to select the appropriate domain. Use the “Media redundancy role:” drop down menu to select “Client”.
- 3) Continuing in the Inspector window, select *Advanced options* +> *Port 1* +> *Port interconnection*. Under “Partner port:”, the partner port you assigned to the port when you drew the topology is shown. If you do not know which port will be the partner port in the actual installation, you can use the drop down menu to select “Any partner”.
- 4) If need be, repeat step 3 for Port 2 of the NR60E2.
- 5) Continue configuring the rest of the devices on the network before compiling the project and downloading it to the CPU.



ADVANCED MICRO CONTROLS INC.

20 GEAR DRIVE, TERRYVILLE, CT 06786 T: (860) 585-1254 F: (860) 584-1973

www.amci.com

LEADERS IN ADVANCED CONTROL PRODUCTS