

Series 1760 Resolver Interface Modules

**1761
1762**

User Manual



Allen-Bradley 1771 I/O Modules

GENERAL INFORMATION

Important User Information

The products and application data described in this manual are useful in a wide variety of different applications. Therefore, the user and others responsible for applying these products described herein are responsible for determining the acceptability for each application. While efforts have been made to provide accurate information within this manual, AMCI assumes no responsibility for the application or the completeness of the information contained herein.

UNDER NO CIRCUMSTANCES WILL ADVANCED MICRO CONTROLS, INC. BE RESPONSIBLE OR LIABLE FOR ANY DAMAGES OR LOSSES, INCLUDING INDIRECT OR CONSEQUENTIAL DAMAGES OR LOSSES, ARISING FROM THE USE OF ANY INFORMATION CONTAINED WITHIN THIS MANUAL, OR THE USE OF ANY PRODUCTS OR SERVICES REFERENCED HEREIN.

No patent liability is assumed by AMCI, with respect to use of information, circuits, equipment, or software described in this manual.

The information contained within this manual is subject to change without notice.

This manual is copyright 2003 by Advanced Micro Controls Inc. You may reproduce this manual, in whole or in part, for your personal use, provided that this copyright notice is included. You may distribute copies of this complete manual in electronic format provided that they are unaltered from the version posted by Advanced Micro Controls Inc. on our official website: www.amci.com. You may incorporate portions of this documents in other literature for use within the company that you own or are employed by, provided you include the notice: "Portions of this document copyright 2003 by Advanced Micro Controls Inc." You may not alter the contents of this document or charge a fee for its reproduction or distribution.

Standard Warranty

ADVANCED MICRO CONTROLS, INC. warrants that all equipment manufactured by it will be free from defects, under normal use, in materials and workmanship for a period of [1] year. Within this warranty period, AMCI shall, at its option, repair or replace, free of charge, any equipment covered by this warranty which is returned, shipping charges prepaid, within one year from date of invoice, and which upon examination proves to be defective in material or workmanship and not caused by accident, misuse, neglect, alteration, improper installation or improper testing.

The provisions of the "STANDARD WARRANTY" are the sole obligations of AMCI and excludes all other warranties expressed or implied. In no event shall AMCI be liable for incidental or consequential damages or for delay in performance of this warranty.

Returns Policy

All equipment being returned to AMCI for repair or replacement, regardless of warranty status, must have a Return Merchandise Authorization number issued by AMCI. Call (860) 585-1254 with the model number and serial number (if applicable) along with a description of the problem. A "RMA" number will be issued. Equipment must be shipped to AMCI with transportation charges prepaid. Title and risk of loss or damage remains with the customer until shipment is received by AMCI.

24 Hour Technical Support Number

24 Hour technical support is available on this product. For technical support, call (860) 583-7271. Your call will be answered by the factory during regular business hours, Monday through Friday, 8AM - 5PM EST. During non-business hours an automated system will ask you to enter the telephone number you can be reached at. Please remember to include your area code. The system will page one of two engineers on call. Please have your product model number and a description of the problem ready before you call.

We Want Your Feedback

Manuals at AMCI are constantly evolving entities. Your questions and comments on this manual are both welcomed and necessary if this manual is to be improved. Please direct all comments to: Technical Documentation, AMCI, 20 Gear Drive, Terryville CT 06786, or fax us at (860) 584-1973. You can also e-mail your questions and comments to techsupport@amci.com

TABLE OF CONTENTS

General Information

Important User Information	IFC
Standard Warranty	IFC
Returns Policy	IFC
24 Hour Technical Support Number	IFC
We Want Your Feedback	IFC

About This Manual

Audience	5
Navigating this Manual	5
Manual Conventions	6
Trademarks and Other Legal Stuff	6
Revision Record	6
Past Revisions	6

Chapter 2: 1761 and 1762

Introduction

Overview	7
Series 1700 Family Members	8
Brushless Resolver Description	9
AMCI Compatible Transducers	10
Other Compatible Transducers	11
Programmable Number of Turns	11
Programmable Parameters	12
Transducer Setup Parameters	12
Count Direction	12
Transducer Type	13
Number of Turns	13
Full Scale Count	13
Circular Offset	14
Linear Offset	15
Preset Value	15
Decimal Point	15
Module Setup Parameters	16
Resolver Type	16
Position Format	16
Transfer Type	16
-10 option	16
PLC Program	17
Backplane Programming	18
Module Setup Command	18
Transducer Setup Command	18
Apply Preset Value Command	18
Auxiliary Commands	18

Chapter 2: Module Description

Front Panel Description	19
Program Mode vs. Display Mode	20
Program Switch	20
Using the Front Panel Display and Keyboard	21
Navigating in Display Mode	21
Navigating in Program Mode	21
Switching Between Channels	21
Indicator LED Patterns	22
Position Display	23
Tachometer Display	23
Setup Parameters	24
Resolver Type	24
Count Direction	24
Transducer Type	24
Number of Turns	25
Full Scale Count	25
Counts per Turn Data	25
Circular Offset	26
Linear Offset	26
Preset Value	26
Decimal Point	26
Position Format	27
Transfer Type	27
PLC Program	27
Error Messages	28
Transducer Fault (Error 1)	28
nvRAM Fault (Error 2)	28
Reference Voltage Fault	29
Transducer Input Connector	29
GC-1 Ground Clamp	30

Chapter 3: Installation

Power Requirements	31
Installing the Module	31
Keying Bands	31
Transducer Specifications	32
Transducer Mounting	32
Transducer Outline Drawings	32
HTT-20-(x) Outline Drawing	33
Transducer Connector Pinout	33
Transducer Cable Installation	34

**Chapter 3: Installation
(continued)**

Transducer Cable Wiring Diagrams 34
 1761 Wiring 34
 1762 Wiring 35
 GC-1 Grounding Clamp 35
 Autotech Transducer Installation 36
 Supported Transducers 36
 Transducer Wiring 36

Chapter 4: Module Addressing

Definition of Terms 37
 Block Transfer 37
 Single Transfer 37
 I/O Rack 37
 I/O Group 37
 Slot Pair 37
 2-Slot Addressing 37
 1-Slot Addressing 38
 1/2-Slot Addressing 38
 Addressing the 1761 or 1762
 as a Block Transfer Module 38
 Addressing Shortcuts 38
 Addressing the 1761 as a
 Single Transfer Module 39
 Addressing Shortcuts 39
 Addressing Examples 39
 2-Slot Addressing 39
 1-Slot Addressing 40
 1/2-Slot Addressing 40
 Restrictions and Warnings 40

**Chapter 5: PLC-5 Block Transfer
Instructions**

Overview 41
 Module Address 41
 Control Block 41
 Data File 41
 File Length 41
 Block Transfer Reads 41
 Block Transfer Writes 42
 Continuous Parameter 42
 Enable (EN), Error (ER), and
 Done (DN) Bits 42
 Programming Example 43
 PLC-5 Restrictions and Warnings 44

Chapter 6: Data Format

Block Transfer Data Format 45
 Single Transfer Data Format 46

Chapter 7: Backplane Programming

Block Transfer Writes 47
 BTW Command Word 48
 Module Setup Command 48
 Programming Bit Values 48
 Transducer Setup Command 49
 Programming Bit Values 49
 Ranges and Factory
 Default Values 50
 Apply Preset Value Command 51
 Programming Bit Values 51
 Auxiliary Commands 51
 Programming Bit Values 52
 Block Transfer Reads 53
 Status, Position and Tachometer Data 53
 Status Bit 54
 Programming Error Bits 54
 Module Setup Data 56
 Transducer Setup Data 56

Chapter 8: Sample PLC-5 Program

Data Table Values 57
 Ladder Logic 58

ABOUT THIS MANUAL

Read this chapter to learn how to navigate through the manual and familiarize yourself with the conventions used in it.

Audience

This manual explains the set-up, installation, and operation of AMCI's 1761 and 1762 Resolver Interface Modules for the Rockwell Automation 1771 I/O PLC platform.

It is written for the engineer responsible for incorporating the 1761 or 1762 into a design, as well as the engineer or technician responsible for their actual installation.

There are thirteen modules in the 1700 Series Intelligent Resolver Interface Modules for Allen-Bradley 1771 I/O. These modules accept one, two, three, or four resolver inputs and convert the resolvers analog signals into digital position and tachometer data that can be transmitted to the processor over the backplane. The series is further broken down into the 1730 modules that are 10-bit, single turn, resolver interface modules; the 1740 modules that are 13-bit, single turn, resolver interface modules; and the 1760 series that are multi-turn resolver interface modules that offer 12-bit resolution per turn.

This manual explains the operation, installation, programming, and servicing the 1761 and 1762 modules. The other eleven module in this series, the 1731, 1732, 1733, 1734, 1741, 1742, 1743, 1744, 1761-01, 1761-21, and 1763, are covered by the following four manuals.

- Series 1700 Intelligent Resolver Interface Module User Manual
- 1761-01 Intelligent Resolver Interface Module with Remote Display User Manual
- 1761-21 Intelligent Resolver Interface Module User Manual
- 1763 Intelligent Resolver Interface Module User Manual

It is strongly recommended that you read the following instructions. If there are any unanswered questions after reading this manual, call the factory. An applications engineer will be available to assist you.

Navigating this Manual

This manual is designed to be used in both printed and on-line forms. Its on-line form is a PDF document, which requires Adobe Acrobat Reader version 4.0+ to open it.

Bookmarks of all the chapter names, section headings, and sub-headings are in the PDF file to help you navigate through it. The bookmarks should have appeared when you opened the file. If they didn't, press the F5 key on Windows platforms to bring them up.

Throughout this manual you will also find *green text that functions as a hyperlink* in HTML documents. Clicking on the text will immediately jump you to the referenced section of the manual. If you are reading a printed manual, most links include page numbers.

The PDF file is password protected to prevent changes to the document. You are allowed to select and copy sections for use in other documents and, if you own Adobe Acrobat version 4.05 or later, you are allowed to add notes and annotations.

Manual Conventions

Three icons are used to highlight important information in the manual:



NOTES highlight important concepts, decisions you must make, or the implications of those decisions.



CAUTIONS tell you when equipment may be damaged if the procedure is not followed properly.



WARNINGS tell you when people may be hurt or equipment may be damaged if the procedure is not followed properly.

The following table shows the text formatting conventions:

Format	Description
Normal Font	Font used throughout this manual.
<i>Emphasis Font</i>	Font used the first time a new term is introduced.
<i>Cross Reference</i>	When viewing the PDF version of the manual, clicking on the cross reference text jumps you to referenced section.

Trademarks and Other Legal Stuff

The AMCI logo is a trademark, and “AMCI” is a registered trademark of Advanced Micro Controls Inc. “PLC-2”, “PLC-3”, and “PLC-5” are registered trademarks of Rockwell Automation. “Viton” is a registered trademark of E.I. DuPont. “Adobe” and “Acrobat” are registered trademarks of Adobe Systems Incorporated. All other trademarks contained herein are the property of their respective holders.

This product is licensed under patents and proprietary technology of Allen-Bradley Company, Inc.. Allen-Bradley Company, Inc. does not warrant or support this product in any manner.

Revision Record

The following is the revision history for this manual. In addition to the information listed here, revisions will fix any known typographical errors and clarification notes may be added.

This manual, 940-07052, supersedes 940-07051. This revision adds a warning about not using the 1761’s single transfer mode in a remote rack. This revision was first released February 4, 2003.

The manual corresponds to software revision 5, checksum 3AA2 for the 1761 and checksum 1930 for the 1762. This software is used on revision H of the main PC board. This software revision adds backplane programmability to both modules and incorporates several features into the 1761 that were only available before as an option before. These new features are described in chapter 1: 1761 and 1762 Introduction. The hardware revision is a change over from through-hole to surface mount components. Minor design enhancements were also included.

Past Revisions

- 1760-591M: Original cataloged manual.
- 1760-B91M: Added Table of Contents and specifications.
- LM1760047: Rev. H board, backplane programming and Autotech compatibility.
- 940-07040: Corrects Autotech wiring and adds Circular Offset example.
- 940-07050: Corrects catalog number.
- 940-07051: Changes format for PDF publishing. Adds HTT-400 information.

1761 AND 1762 INTRODUCTION

This chapter serves as an introduction to the 1761 and 1762 modules. It highlights potential applications, compatible transducers, and all of the modules' features, including those added since the last revision.

Overview

The 1761 and 1762 modules are Allen Bradley 1771 I/O compliant cards that convert resolver signals to digital multi-turn position and tachometer data that can be reported over the backplane using either block or single transfers. These modules eliminate the separate resolver decoder box, PLC input card, and associated wiring needed to bring the digital data into a PLC.

Like an absolute optical encoder, a resolver is a single turn absolute sensor that converts an angle into electrical signals. However, this is where the similarities end. The resolver is an analog device that does not contain sensitive components such as optics and electronics that may be damaged by severe environmental conditions. Also, the position resolution of a resolver is limited only by the electronics that decode its signals. When attached to a 1761 or 1762 module, the resolver gives an absolute 12-bit position value.

The transducers that connect to the 1761 and 1762 contain two resolvers. These resolvers are geared together in a vernier arrangement. The module decodes the separate resolvers and combines their positions into an absolute multi-turn position. The 1761 accepts a single dual-resolver transducer while the 1762 accepts two transducers.

A 1760 module application generally falls into one of two categories.

- ▶ **Rotary Application** - The resolver position directly correlates to an angular position on the machine. One example is monitoring a rotary table by attaching a multi-turn transducer to the drive motor. As the motor rotates, the transducer position is used to monitor and control such functions as motor braking to stop the table at its stations.
- ▶ **Linear Application** - The resolver position correlates to a physical length. One example is a packaging machine where the transducer completes multiple turns for each product. Here the transducer position is used to control when glue is applied or when the package is cut to length. Another example of a multi-turn application is monitoring the position of a load on either a track or ball screw. In this type of application, linear position is translated to rotary position through either a wheel or gearing. The transducer completes several rotations in order to travel the complete linear distance.

AMCI also has a line of cable reel transducers for use in some linear applications. A cable reel transducer has a stranded stainless steel cable wrapped around a spring loaded drum. As the cable is pulled out of the transducer, the drum rotates, which in turn rotates the internal resolvers. The cable is retracted by the force of the drums' spring. Distances of up to forty-five feet can be measured with these transducers.



Figure 1.1 1762 Module



Overview (continued)

Both modules have programmable *Transducer Setup Parameters* that allow you to scale and adjust the position and tachometer data. Additional *Module Setup Parameters* define the type of transducer attached to the module, the digital format of the position data, and how the module communicates with the processor. The 1761 module can be configured to use either block or single transfers.

When configured to use block transfers, you can further configure the module to accept programming instructions and commands over the backplane. With backplane programming enabled, you can force the module to read back parameter values instead of position and tachometer data.

Series 1700 Family Members

The thirteen modules in the 1700 series are shown in the table below. The shaded out models are modules not covered in this manual. Refer to *Audience* on page 5, for more information on the manuals for these modules.

Model	Transducer Inputs	Resolution
1761	1	12 bit (4,096) per turn, 180 turns max. (737,280 counts max.) 1,000 and 1,800 turn transducers are also available. Using these transducers will reduce the resolution to 409.6 counts per turn.
1762	2	12 bit (4,096) per turn, 180 turns max. (737,280 counts max.) 1,000 and 1,800 turn transducers are also available. Using these transducers will reduce the resolution to 409.6 counts per turn.
1731	1	10 bit (1,024 counts)
1732	2	10 bit (1,024 counts)
1733	3	10 bit (1,024 counts)
1734	4	10 bit (1,024 counts)
1741	1	13 bit (8,192 counts)
1742	2	13 bit (8,192 counts)
1743	3	13 bit (8,192 counts)
1744	4	13 bit (8,192 counts)
1761-01	1	12 bit (4,096) per turn, 180 turns max. (737,280 counts max.) Has a serial output for connection to AMCI's 6100F or 6200F Remote Displays.
1761-21	1	12 bit (4,096) per turn, 180 turns max. (737,280 counts max.) Reset input. Programmable to fractional number of turns.
1763	1	10 bit (1,024) per turn, 10,000 turns max. (10,000,000 counts max.)

Table 1.1 Series 1700 Family Members

See *AMCI Compatible Transducers* on page 10 for information on the AMCI transducers compatible with the 1761 and 1762.

Brushless Resolver Description

The brushless resolver is unsurpassed by any other type of rotary position transducer in its ability to withstand the harsh industrial environment. An analog sensor that is absolute over a single turn, the resolver was originally developed for military applications and has benefited from more than 50 years of continuous use and development.

The resolver is essentially a rotary transformer with one important distinction. The energy coupled through a rotary transformer is not affected by shaft position whereas the magnitude of energy coupled through a resolver varies sinusoidally as the shaft rotates. A resolver has one primary winding, the Reference Winding, and two secondary windings, the SIN and COS Windings. (See figure 1.2, *Resolver Cut Away View*). The Reference Winding is located in the rotor of the resolver, the SIN and COS Windings in the stator. The SIN and COS Windings are mechanically displaced 90 degrees from each other. In a brushless resolver, energy is supplied from the Reference Winding to the rotor by a rotary transformer. This eliminates brushes and slip rings in the resolver and the reliability problems associated with them.

In general, the Reference Winding is excited by an AC voltage called the Reference Voltage (V_r). (See figure 1.3, *Resolver Schematic*). The induced voltages in the SIN and COS Windings are equal to the value of the Reference Voltage multiplied by the SIN or COS of the angle of the input shaft from a fixed zero point. Thus, the resolver provides two voltages whose ratio represents the absolute position of the input shaft. ($\text{SIN } \theta / \text{COS } \theta = \text{TAN } \theta$, where θ = shaft angle.) Because the ratio of the SIN and COS voltages is considered, any changes in the resolvers' characteristics, such as those caused by aging or a change in temperature, are ignored.

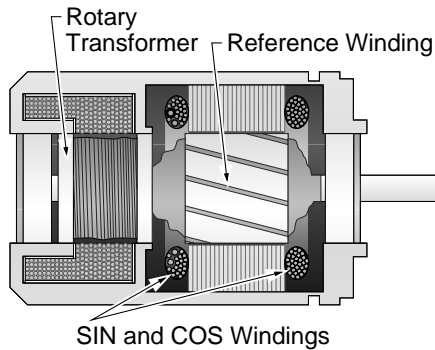

Figure 1.2 Resolver Cut Away View

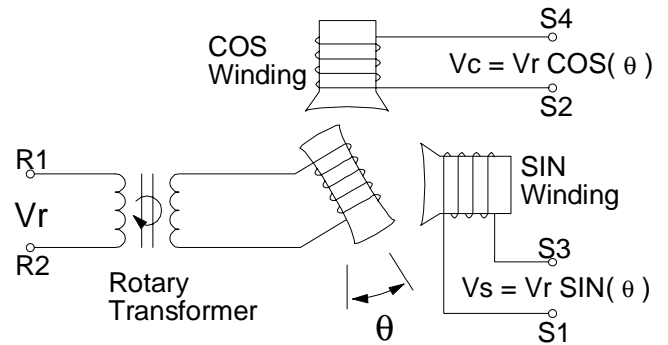

Figure 1.3 Resolver Schematic

AMCI Compatible Transducers

Table 1.2 lists the AMCI transducers compatible with the 1761 and 1762 modules.

Model	Shaft	Mount	Turns	Comments
HTT-20-100	0.625"	Front	100	NEMA 13 heavy duty transducer
HTT-20-180	0.625"	Front	180	NEMA 13 heavy duty transducer
HTT-20-1000	0.625"	Front	1,000	HTT-20-100 w/ additional 10:1 gearing on input shaft.
HTT-20-1800	0.625"	Front	1,800	HTT-20-180 w/ additional 10:1 gearing on input shaft.
HTT425-Ann-100†	0.250"	Motor	100	A-B Series 1326 motor mount transducer. "nn" in part number defines connector style.
HTT425-Mnn-100†	10 mm	Motor	100	Universal motor mount w/ required adapter plate. "nn" in part number defines connector style.
HTT425-Fnn-100†	0.625"	Front	100	NEMA 4X, HTT-20-100 w/ Viton shaft seal. "nn" in part number defines connector style.
HTT425-Tnn-100†	0.625"	Foot	100	NEMA 4X, HTT-20-100 w/ Viton shaft seal. "nn" in part number defines connector style.
HTT-400-180	0.625"	Front	180	NEMA 4, HTT-20-180. Bolt-in replacement for Autotech RL210 transducers.
HTTCR-9n-100	0.047" Cable	Foot	540"	Cable Reel Transducer, 540" span, 0.003" max. resolution, 45 ft stranded stainless cable standard.

† A 1,000 turn version is also available.

Table 1.2 Compatible AMCI Transducers

Each transducer contains two resolvers. The first resolver, called the fine resolver, is attached directly to the input shaft with a flexible coupler. The second resolver, called the course resolver, is geared to the fine. This gear ratio, either 99:100 or 179:180 determines the total number of turns the transducer can encode.

At the mechanical zero of the transducer, the electrical zeros of the two resolvers are aligned. See Figure 1.4A. After one complete rotation, the zero of the course resolver lags behind the zero of the fine by one tooth, either 1/100 or 1/180 of a turn. After two rotations the lag is 2/100 or 2/180. See Figures 1.4B and 1.4C. After 100 or 180 turns, the electrical zeros of the resolvers are realigned and the multi-turn cycle begins again.

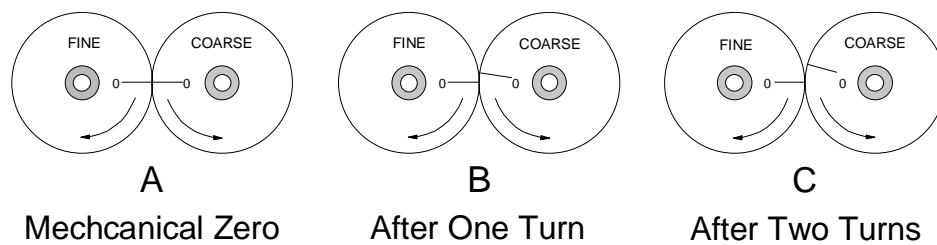

Figure 1.4 Resolver Alignment in Multi-turn Transducers

The fine resolver yields the absolute position within the turn directly. Using a proprietary algorithm, the module determines the number of turns completed by the difference in positions of the two resolvers. The absolute multi-turn position is then calculated as ((number of turns completed * counts per turn) + fine resolver position).

The 1,000 and 1,800 turn transducers have a 10:1 gear ratio between the input shaft and the resolvers. Therefore they can encode ten times the number of turns but at a tenth of the resolution.

Other Compatible Transducers

In addition to AMCI transducers, the 1761 and 1762 modules now directly support Autotech multi-turn transducers. The Autotech models supported are:

- ▶ All SAC-RL210-G128 Transducers. (Size 40, NEMA 13)

Autotech also manufactures a SAC-RL210-G64 transducer which is not supported by AMCI.

You select between AMCI and Autotech transducers from the keyboard and display or over the backplane from the processor. The module then sets the reference voltage according to your selection. When using Autotech transducers, only 10 bit resolution, (1,024 counts per turn), is supported. If you require a higher resolution in an Autotech style package, AMCI offers the HTT-400-180, which is a direct bolt-in replacement for the Autotech RL210. AMCI strongly suggests using the HTT-400-180 transducer instead of the Autotech RL210 in all new installations.

If you have a 1762 module, both transducers must be either AMCI or Autotech. You cannot bring both types of transducers into a single card.

Programmable Number of Turns

The maximum number of turns a transducer can encode is fixed by the gearing inside of it. However, the 1761 and 1762 have the ability to divide this maximum number of turns into smaller multi-turn cycles. The module does this without loss of absolute position within the smaller cycle. An example of this feature is shown in figure 1.5. It shows how the 180 turn mechanical cycle of an HTT-20-180 can be broken down into three electronic cycles of sixty turns each. The 180 turn cycle could also be broken down into sixty cycles of three turns each.

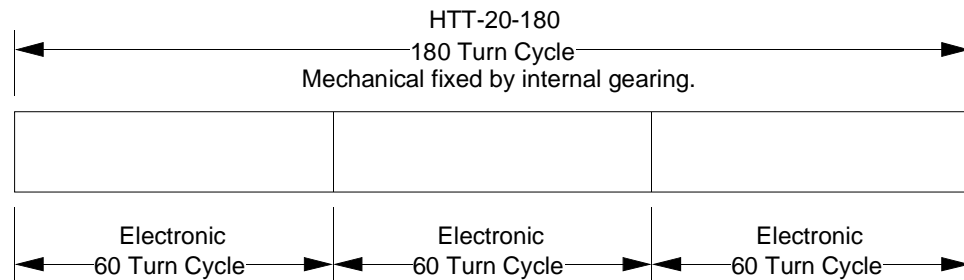

Figure 1.5 Programmable Number of Turns Example

You program the number of turns you want the module to decode from the front panel or over the backplane.

- ▶ **When using a 100 turn transducer**, the number of turns is programmable to 1, 2, 4, 5, 10, 20, 25, 50, or 100.
- ▶ **When using a 180 turn transducer**, the number of turns is programmable to 1, 2, 3, 4, 5, 6, 9, 10, 12, 15, 18, 20, 30, 36, 45, 60, 90, or 180.
- ▶ **When using a 1,000 turn transducer**, the number of turns is programmable to 10, 20, 40, 50, 100, 200, 250, 500, or 1,000.
- ▶ **When using a HTT-20-1800**, the number of turns is programmable to 10, 20, 30, 40, 50, 60, 90, 100, 120, 150, 180, 200, 300, 360, 450, 600, 900, or 1,800.
- ▶ **When using an Autotech SAC-RL210-G128**, the number of turns is programmable to 1, 2, 4, 8, 16, 32, 64, or 128.

The remainder of this chapter introduces the many programmable features of the 1761 and 1762 modules. It also introduces backplane programming concepts that allows you to control the module from the processor instead of using the modules keyboard and display.

Programmable Parameters

A 1761 or 1762 module is configured by setting its programmable parameters. Parameters are broken into two groups.

- **Transducer Setup Parameters** - Nine parameters that affect the data of each transducer. The 1762 module repeats these parameters for each transducer. For example, a 1762 has two Circular Offset parameters, one for each transducer. These parameters are programmable from the keyboard or the processor.
- **Module Setup Parameters** - Four parameters that set module communication with the processor and the type of resolvers attached to the card. There is only one of each of these parameters.

Programmable parameters are stored in the modules nonvolatile memory. Therefore, you do not have to configure the module after every power up. Prior to hardware revision H of the module, the nonvolatile memory was EEPROM. This technology has the advantage of retaining programmed values for over 100 years. Its disadvantage is its limited number of write cycles, approximately ten thousand, before the memory would begin to fail.

With revision H, the nonvolatile memory has been changed to battery backed, non-volatile, static RAM (nvRAM). The battery in the nvRAM is rated for ten years but the nvRAM has an unlimited number of write cycles. The nvRAM has the additional advantage of significantly decreasing the time needed to store new parameter values.

Transducer Setup Parameters

Count Direction

This new parameter sets the direction of transducer shaft rotation to increase the position count. *If the transducer cable is wired as specified in this manual* and the count direction is set to *positive*, the position count will increase with clockwise rotation (looking at the shaft). If the count direction is set to *negative*, the position count will increase with counter-clockwise rotation.

- The Count Direction default value is *positive*.

NOTE

It is also possible to reverse the count direction by reversing four wires in the transducer cable. If you are installing this module either as a replacement for an older module or on a machine that is a copy installation of a previous system, you will probably not need to set this parameter. Once the machine is setup, you can easily change this parameter if the position is increasing in the wrong direction.

Transducer Setup Parameters (continued)

Transducer Type

This parameter specifies the type of transducer attached to the input channel. The module needs this information in order to combine the positions of the two resolver inside the transducer into one multi-turn position. The *Resolver Type* parameter, which is one of the Module Setup Parameters and described on page 16, controls what values this parameter can be set to.

When *Resolver Type* is set to *AMCI (res_1)*, the Transducer Type parameter can be set to:

- 100 Turn transducer (default value)
- 180 Turn transducer
- 1,000 Turn transducer
- 1,800 Turn transducer

When the *Resolver Type* is set to *Autotech (res_2)*, the Transducer Type parameter is fixed. It specifies a 128 turn transducer. You cannot use the Autotech SAC-RL210-G064 sixty-four turn transducer as it is not compatible with the 1760 modules.

Number of Turns

The Number of Turns parameter sets the number of turns needed to complete one multi-turn cycle. The values that can be programmed into this parameter is dependent on the value of the Transducer Type parameter. See above for a description of the Transducer Type Parameter.

- When using a 100 turn transducer, the number of turns is programmable to 1, 2, 4, 5, 10, 20, 25, 50, or 100.
- When using a 180 turn transducer, the number of turns is programmable to 1, 2, 3, 4, 5, 6, 9, 10, 12, 15, 18, 20, 30, 36, 45, 60, 90, or 180.
- When using a 1,000 turn transducer, the number of turns is programmable to 10, 20, 40, 50, 100, 200, 250, 500, or 1,000.
- When using a HTT-20-1800, the number of turns is programmable to 10, 20, 30, 40, 50, 60, 90, 100, 120, 150, 180, 200, 300, 360, 450, 600, 900, or 1,800.
- When using a SAC-RL210-G128, the number of turns is programmable to 1, 2, 4, 8, 16, 32, 64, or 128.

The default value of this parameter is equal to the programmed value of the Transducer Type Parameter. Programming the Transducer Type parameter resets the Number of Turns to its default value.

Full Scale Count

The Full Scale Count parameter specifies the number of counts over the programmed number of turns.

AMCI Transducers

- Default value is (Number of Turns * 4,096) if 100 or 180 turn transducer
- Default value is (Number of Turns * 409.6) if 1,000 or 1,800 turn transducer
- Range is 2 to (Default Value)

Autotech Transducers

- Default value is (Number of Turns parameter) * 1,024
- Range is 2 to (Default Value)

Programming the Transducer Type parameter or Number of Turns parameter resets the Full Scale Count to its default value.



Transducer Setup Parameters (continued)

Circular Offset

The Circular Offset lets you change the position count without rotating the transducer shaft. This offset is most commonly used to force the position to the correct count after the machine has been mechanically aligned.

- ▶ The Circular Offset default value is zero.
- ▶ The Circular Offset can be programmed from zero to (Full Scale Count - 1).

Programming the Transducer Type, Number of Turns, or Full Scale Count parameter resets the Circular Offset to zero.

Use the following formulas to calculate the Circular Offset if the offset presently equals zero.

If Desired Position > Current Position:

Circular Offset = Desired Position – Current Position

Example 1: Current Position = 7,412
Desired Position = 20,000
Circular Offset = 20,000 – 7,412 = 12,588

If Desired Position < Current Position:

Circular Offset = Full Scale Count – (Current Position – Desired Position)

Example 2: Full Scale Count = 409,600 (Number of Turns = 100, Counts per Turn = 4,096)
Current Position = 353,200
Desired Position = 104,000
Circular Offset = 409,600 – (353,200 – 104,000) = 409,600 – (249,200) = 160,400

If the Circular Offset is not zero when calculating a new offset, then it must be taken into account. Calculate your new Circular Offset as shown in the examples above and then add the current Circular Offset value to your answer. If this new value exceeds the Full Scale Count, then subtract the Full Scale Count from this new value.

To continue Example 2 above:

Full Scale Count = 409,600 Calculated Circular Offset = 160,400
Present Circular Offset = 354,200
Circular Offset = 160,400 + 354,200 = 514,600.
Note that this exceeds the Full Scale Count of 409,600.
New Circular Offset = 514,600 – 409,600 = 105,000

NOTE

- 1) The range of the Circular Offset is zero to (Full Scale Count - 1).
- 2) If the calculated Circular Offset exceeds the Full Scale Count, the actual offset is:
Calculated offset - Full Scale Count = Actual Circular Offset
- 3) The **Preset Value** parameter, described on page 15, is directly related to the Circular Offset. Presetting the position count to the Preset Value is accomplished by recalculating the Circular Offset.

Transducer Setup Parameters (continued)

Linear Offset

The Linear Offset changes the range of position counts by adding a fixed number to it. The Linear Offsets use is best illustrated with an example.

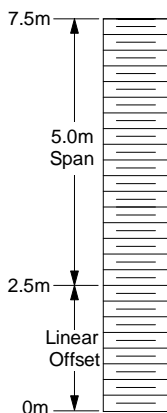

Figure 1.6
Linear Offset
Example

A 1761 is used to measure a 5.000 meter span with one millimeter resolution. Therefore, the total number of counts over the full travel is:

$$5.000 \text{ meters} * 1000 \text{ mm/meter} = 5000 \text{ counts.}$$

The Full Scale Count parameter is then set to this value.

The 5.000 meters that the transducer measures is in the range of 2.500 to 7.500 meters on the machine. You can use the Linear Offset to force the module to send the position data to the processor in the correct format instead of using the processor to add the offset once the position value is in the data table. The formula for the Linear Offset is:

$$\begin{aligned} \text{Minimum Desired Value} * \text{Resolution} &= \text{Linear Offset} \\ 2.500 \text{ meters} * 1000 \text{ mm/meter} &= 2500 \text{ counts} \end{aligned}$$

- The Linear Offset default value is zero.
- The Linear Offset can be programmed from zero to $(999,999 - (\text{FSC}^\dagger - 1))$.

Programming the Transducer Type, Number of Turns, or Full Scale Count parameters resets the Linear Offset to zero.

Preset Value

The Preset Value parameter allows you to set the value of position count without calculating the required offset. Programming the Preset Value does not change the position data, it only sets the count that the position will change to when an *Apply Preset Value Command* is initiated from the backplane or when an operator clears the position from the keyboard.

- The Preset Value defaults to zero.
- The Preset Value can be programmed from zero to $(\text{Full Scale Count} - 1)$.
- If the Linear Offset value is not equal to zero, the new position count will be $(\text{Linear Offset} + \text{Preset Value})$ after it is preset.

Programming the Transducer Type, Number of Turns, or Full Scale Count parameter resets the Preset Value to zero.

Decimal Point

This parameter sets the position of a decimal point on many of the modules' displays and is for the user only. It does not affect the data sent over the backplane. For example, your travel is measured in inches and your resolution is one thousandth of an inch. Setting a decimal point at three forces many of the displays to show 'nnn.nnn' where nnnnnn is the present value.

- The Decimal Point defaults to zero.
- The Decimal Point can be programmed from zero to five digits to the right of the decimal point.

Programming the Transducer Type, Number of Turns, or Full Scale Count parameter resets the Decimal Point to zero.

Module Setup Parameters

Resolver Type

The Resolver Type parameter is a new parameter that makes Autotech 128 turn transducers compatible with the 1761 and 1762 modules. Autotech sixty-four turn transducers are not supported.

- The Resolver Type default value is AMCI, (*res_1*). If you are using Autotech transducers, set this parameter to (*res_2*).
- The Resolver Type parameter can be changed from the front panel or the backplane.

NOTE  If you have a 1762 module, both transducers must be either AMCI or Autotech. You cannot bring both types of transducers into a single card.

Position Format

This parameter allows you to choose the format of the position data reported over the backplane. The choices are *Binary* or *BCD*. It is included for PLC-2 users that require BCD data for PLC-2 math instructions. All other applications should choose the *Binary* format.

- The Position Format parameter default value is Binary.
- The Position Format parameter can be changed from the front panel or the backplane.

NOTE  This parameter affects position data only. Tachometer data is always transferred in binary format.

Transfer Type

If you have a 1761 module, this parameter allows you to define how the module will communicate over the backplane. You select either block or single transfer. All 1762 modules have this parameter locked to the block transfer value.

- The Transfer Type default value is block transfer.
- The Transfer Type can only be changed from the keyboard.

NOTE  1) If you configure the module for single transfers, you will not be able to program the module from the backplane.
2) If you configure the module for single transfers, the *Position Format* parameter, (see above), will be locked to its Binary value.
3) If you configure the module for single transfers, the module must be installed in a chassis using 1-slot or ½-slot addressing.
4) After changing this parameter, you *must* cycle power to the module to re-initialize the A-B backplane interface chip.

-10 option

Prior to hardware revision H, customers could order modules with 32 bit single transfer by adding “-10” to the end of the part number. This practice has been eliminated because 32 bit single transfer is now standard on the modules. If your module is a replacement for an older “-10” module, it will work correctly if the Transfer Type parameter is set to *Single*.



Module Setup Parameters (continued)

PLC Program

The PLC Program parameter tells the module to accept or ignore programming instructions from the backplane. This parameter is only available if you have selected block transfers with the *Transfer Type* parameter.

The default value of the PLC Program parameter, *Read Only*, prevents the module from accepting programming instructions. In order to enable backplane programming, you must set the parameter to program enabled.

The PLC Program parameter is only programmable from the keyboard.

NOTE

- 1) When in *Read Only* mode the block transfer read length is three words long for a 1761 or six words for a 1762.
- 2) When backplane programmable, all block transfers to the modules are ten words long. Because of this, you may have to modify your existing data file sizes as well as your ladder logic if upgrading your system.
- 3) After changing this parameter, you *must* cycle power to the module to re-initialize the A-B backplane interface chip.

Backplane Programming

When a 1761 or 1762 module is configured to use block transfers, you have the option of programming the module using data sent to it with block transfer writes. (See *Transfer Type* on page 16 and *PLC Program* on page 17.) All block transfer writes to a 1761 or 1762 are ten words long. The first word of the block transfer write is called the *Command Word*. As shown in figure 1.7, the four most significant bits of this word define what programming data is being transferred to the module.

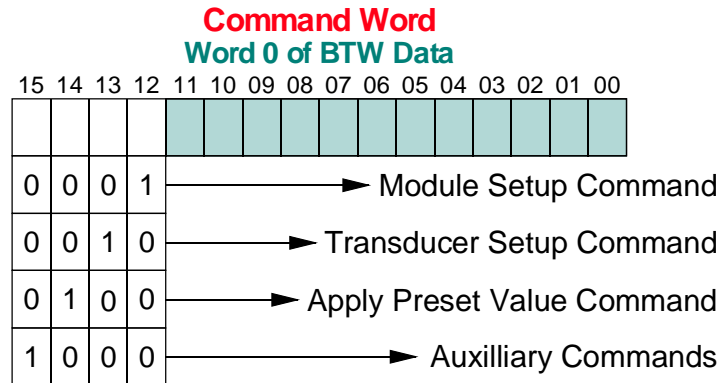

Figure 1.7 Command Word Format

Module Setup Command

Use the Module Setup block transfer to program the Resolver Type and Position Format parameters. These are the only Module Setup Parameters that can be programmed from the backplane.

Transducer Setup Command

Use the Transducer Setup block transfer to program all of the Transducer Setup parameters. Only one channel can be programmed at a time. Therefore two block transfers are required to program all of a 1762's Transducer Setup parameters.

Apply Preset Value Command

This block transfer presets the transducer position to the value specified by the Preset Value and Linear Offset parameters. This block transfer does not program any parameters.

Auxiliary Commands

This block transfer allows you to perform the following functions:

- Clear any programming errors or transducer faults.
- Disable or Enable programming from the front panel.
- Specify the data read from the module using block transfer reads.
 - 1) Position and Tachometer Data
 - 2) Module Setup Parameters
 - 3) Transducer Setup Parameters

MODULE DESCRIPTION

Front Panel Description

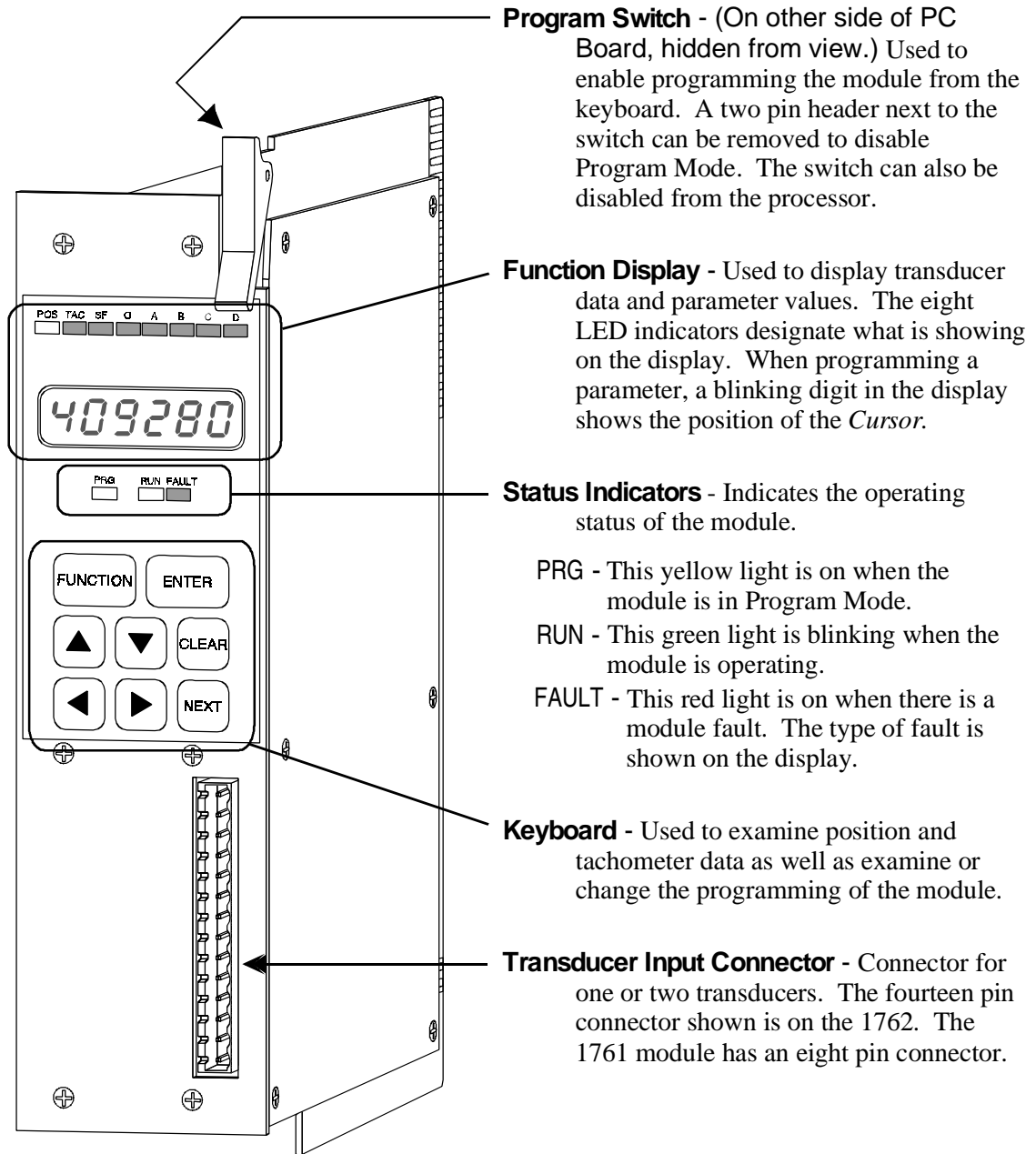

Figure 2.1 1761/1762 Front Panel Description



Program Mode vs. Display Mode

The front panel has two operating modes.

- **Program Mode – (Yellow PRG light on)** The parameters can be modified from the keyboard. The position can be preset by pressing the [CLEAR] key while displaying the position value.
- **Display Mode – (Yellow PRG light off)** The parameters can be inspected, but not modified. You cannot preset the position from the keyboard.

Program Mode and Display Mode refer to the modules' front panel only. Once enabled by setting the *Transfer Type* and *PLC Program* parameters appropriately, you can always program the module from the backplane.

The module can be locked into Display Mode in one of two ways. The first is by removing a jumper on the module. The second is writing the *Disable Keyboard* command, which is one of the *Auxiliary Commands*, from the processor. It is usually good practice to lock the module in display mode once the system is operational. This will prevent someone from accidentally changing the parameters while the system is running. The only time that changes to the programming should be allowed is during set-up or trouble shooting procedures.

Program Switch

The Program Switch is used to quickly enable or disable program mode as long as the module has not been locked in display mode from the processor. The module is in program mode when the switch is pushed towards the back of the module. The module is in display mode when the switch is pushed towards the front of the module. The yellow PRG light is on when the module is in program mode.

The Program Switch can be disabled by removing the jumper on the two pin header next to the switch. Removing this jumper locks the 1700 in display mode. You can also lock the module in display mode with the *Disable Keyboard* auxiliary command.



WARNING

Remove system power before removing or installing any module in an I/O chassis. Failure to observe this warning can result in damage to the module's circuitry and/or undesired operation with possible injury to personnel.

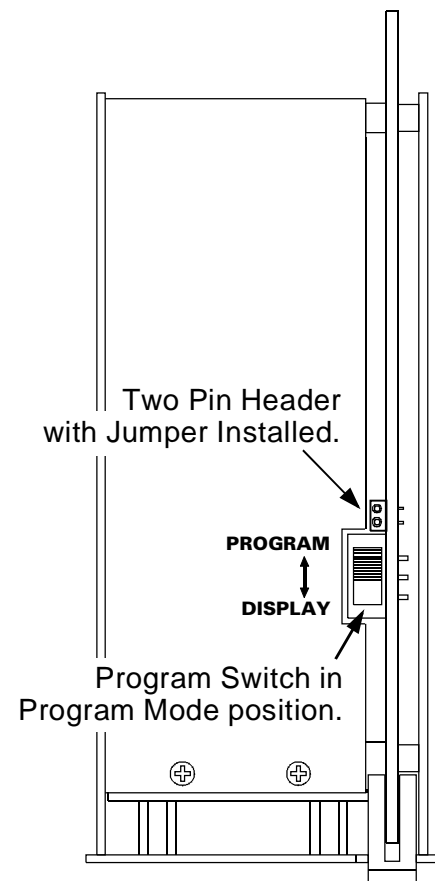

Figure 2.2 Program Switch

Using the Front Panel Display and Keyboard

You can examine position and tachometer values as well as inspect or program all of the programmable parameters using the display and keyboard. The [FUNCTION] key, along with the [◀] and [▶] keys, are used to cycle between the displays. Figure 2.3 shows the display order.

Navigating in Display Mode

When compared to program mode, display mode is easier to navigate. If you are unfamiliar with the module, learn how to navigate between displays while in display mode. Navigating in program mode will then be easier to learn.

The [FUNCTION] and [▶] keys cycle you through the displays in one direction (Down in the figure). The [◀] key cycles you through the displays in the opposite direction. Note that the display order is circular. If the Transducer Type parameter is set to block transfers, pressing the [FUNCTION] key while displaying the PLC Program parameter will return you to the position display. Pressing the [◀] key will then return you the PLC Program parameter. If the Transfer Type parameter is set to *single transfers* the PLC Program parameter is not displayed.

Navigating in Program Mode

The [FUNCTION] key is still used to cycle through the displays.

When you switch to a parameter display, the first digit of the value will be blinking. This shows the position of the *Cursor*. Use the [◀] and [▶] keys to move the cursor and the [▲] and [▼] keys to change the value of the digit under the cursor. To quickly set most parameters to zero, press the [CLEAR] key. Once the parameter value is correct, press the [ENTER] key to accept it. The cursor is removed from the display if the new value is valid.

The module will only accept valid values for the parameters. If the module does not accept a value, it will return the display to the last valid number and move the cursor to the first digit. The valid range for many parameters is based on the values of other parameters. If the module is not accepting a new value, check the other parameter settings.

Pressing the [FUNCTION] key at any time will remove the cursor and the module will display the last valid setting for the parameter. You can then use [FUNCTION], [◀], or [▶] keys to move to the next or previous display.

Switching Between Channels

Pressing the [NEXT] key will switch between the two transducer channels of a 1762 when displaying the position value, tachometer value, or transducer setup parameters. You will remain in the same display, only switch channels.

The 'D' Indicator LED usually tells you which channel is being displayed. It is off when displaying channel one and on when displaying channel two. The one exception is the Count Direction display. This display shows “dir” followed by the channel number.

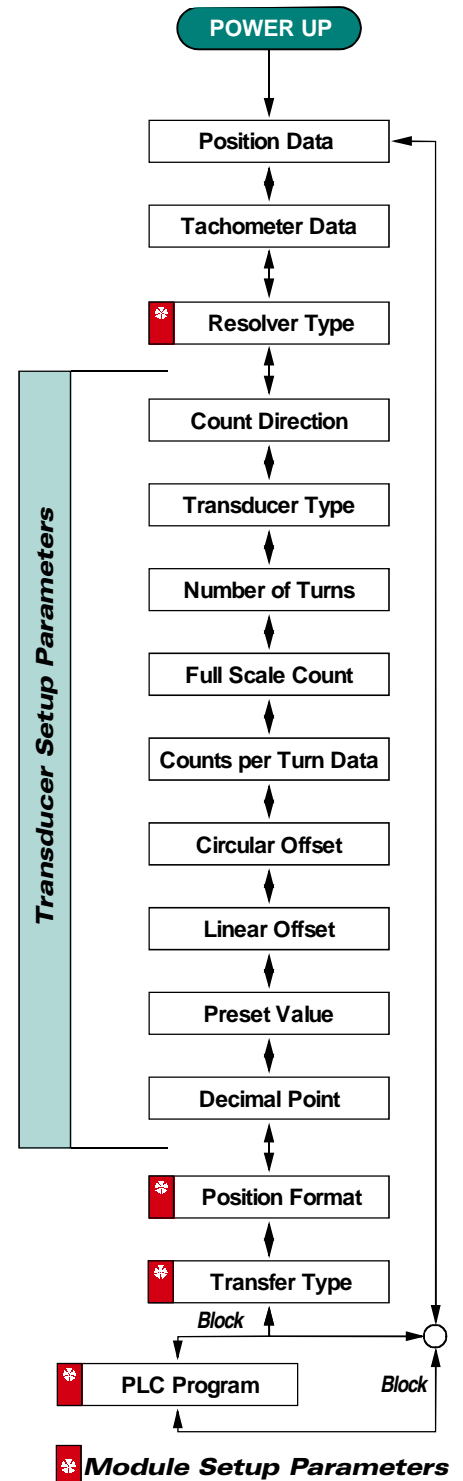

Figure 2.3 Module Display Order



Indicator LED Patterns

The eight LEDs above the seven segment displays are the indicator LEDs. Figure 2.4 is a list of the displays and their indicator LED patterns. Note that some of the parameters have the same indicator pattern. In these cases, the actual displays are different enough to distinguish between the parameters.

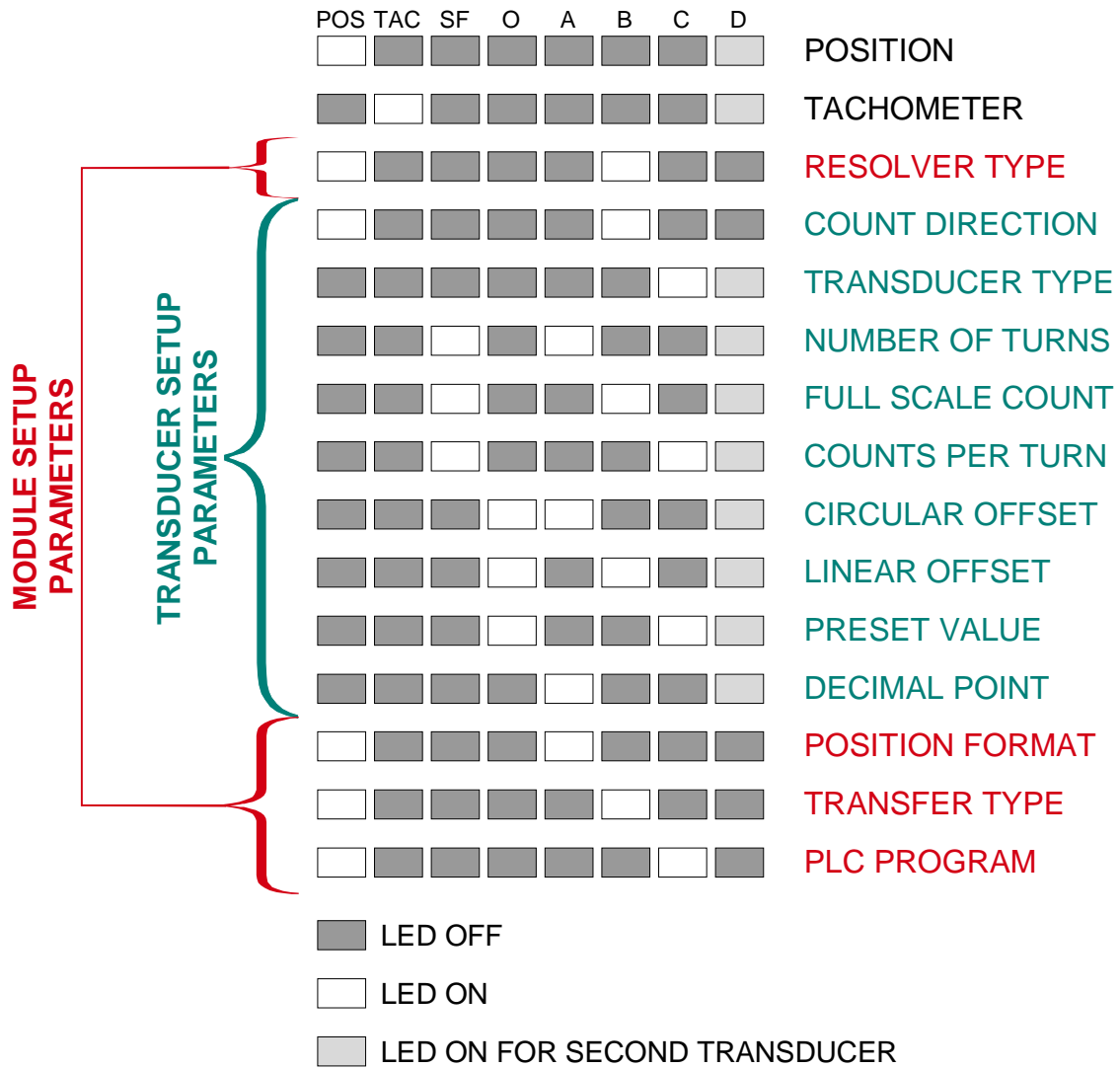

Figure 2.4 Indicator LED Patterns

Position Display

As shown in figure 2.5a, the position display shows the current position when a transducer is properly attached to the channel. If you using a 1762 module, press the **[NEXT]** key to switch between the position displays.

If there is a transducer fault on one channel, you will still be able to view the position of the other channel. If there is a transducer fault on the first input channel, the position display will change to the one shown in figure 2.5b. If the fault is on the second channel the display will read “ERR1_2”. If both channels are faulted the display will read “Err1_b”.

The red FAULT LED is lit when there is a transducer fault. If this LED is on while the position is displayed, the fault is on the other channel. Use the **[NEXT]** key to switch to the faulted channel. The fault can be cleared by pressing the **[CLEAR]** key if the 'Err1' message is blinking.

Refer to *Transducer Fault (Error 1)* on page 28 for more information on the causes of a transducer fault.

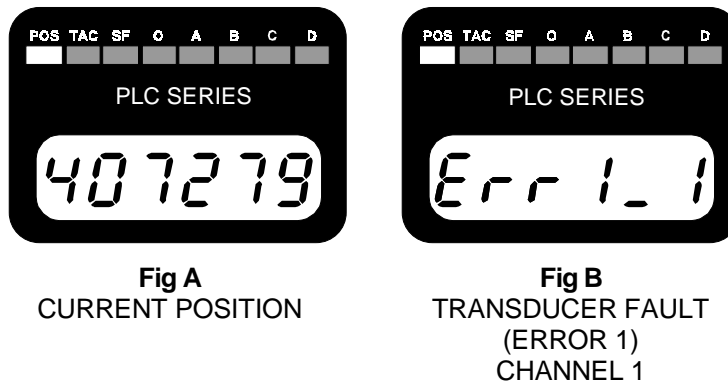

Figure 2.5 Position and Transducer Fault Displays

If the module is in Program Mode, (keyboard programming enabled), pressing the **[CLEAR]** key will preset the position to the value programmed into the Preset Value parameter. An explanation of the *Preset Value* can be found on page 15.

Tachometer Display



Figure 2.6 Tachometer Display

The tachometer display shows the current speed of the transducer in revolutions per minute with 1.0 RPM resolution. The update time for the tachometer is fixed at 32 milliseconds.

If there is a transducer fault, the display will show the 'Err1' message instead of the current speed. (See *Position Display* above.) The red FAULT LED is lit when there is a transducer fault. If this LED is on while the tachometer is displayed, the fault is on the other channel. Use the **[NEXT]** key to switch to the faulted channel. The fault can be cleared by pressing the **[CLEAR]** key if the 'Err1' message is blinking.

Setup Parameters

The following are the front panel displays of the module and transducer setup parameters in the order that they are displayed on the front panel. Along with the displays are default values, range of values, and any special programming instructions. If you have a 1762, use the **[NEXT]** key to switch between the two channels. The Transducer Setup parameters are the only parameters repeated for the second channel of the 1762 module.

The page number given in the heading is the page in chapter one that more fully describes the function of the parameter.

Resolver Type: Module Setup Parameter, Pg. 16



Figure 2.7
Resolver Type

Default: 1 – AMCI resolvers

Range: 1 – AMCI resolvers
2 – Autotech Resolvers



NOTE Programming this parameter will reset the Transducer Type, Number of Turns, Full Scale Count, Circular Offset, Linear Offset, and Preset Value parameters to their default values.

Count Direction: Transducer Setup Parameter, Pg. 12

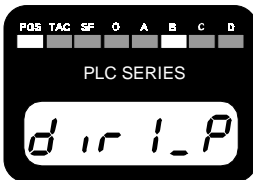

Figure 2.8
Count Direction

Default: Positive. (Clockwise increasing counts)

Range: Positive (Clockwise increasing)
Negative (Counter-clockwise increasing)

Special: The [▲] and [▼] keys change the entire value, not one digit. The [◀] and [▶] keys have no effect. The transducer channel number is the fourth digit, after 'dir'.

Transducer Type: Transducer Setup Parameter, Pg. 13



Figure 2.9
Transducer Type

Default: 100 Turn Transducer (Resolver Type = AMCI)
128 Turn Transducer (Resolver Type = Autotech)

Range: 100, 180, 1,000, 1,800 Turn (Resolver Type = AMCI)
128 Turn (Resolver Type = Autotech)

Special: The [▲] and [▼] keys change the entire value, not one digit. The [◀] and [▶] keys have no effect.



NOTE Programming this parameter will reset the Number of Turns, Full Scale Count, Circular Offset, Linear Offset, and Preset Value parameters to their default values. Programming the Resolver Type parameter resets this parameter to its default value.

Setup Parameters (continued)

Number of Turns: Transducer Setup Parameter, Pg. 13



Figure 2.10
Number of Turns

Default: Programmed value of the Transducer Type parameter.

Range: 100 Turn Transducer: 1, 2, 4, 5, 10, 20, 25, 50, 100.

180 Turn Transducer: 1, 2, 3, 4, 5, 6, 9, 10, 12, 15, 18, 20, 30, 36, 45, 60, 90, or 180.

1,000 Turn Transducer: 10, 20, 40, 50, 100, 200, 250, 500, or 1,000.

1,800 Turn Transducer: 10, 20, 30, 40, 50, 60, 90, 100, 120, 150, 180, 200, 300, 360, 450, 600, 900, or 1,800.

128 Turn Transducer: 1, 2, 4, 8, 16, 32, 64, 128.



NOTE Programming this parameter will reset the Full Scale Count, Circular Offset, Linear Offset, and Preset Value parameters to their default values. Programming the Resolver Type or Transducer Type parameters resets this parameter to its default value.

Full Scale Count: Transducer Setup Parameter, Pg. 13



Figure 2.11
Full Scale Count

Defaults: ((Number of Turns) * 4,096) if AMCI 100 or 180 turn transducer
 ((Number of Turns) * 409.6) if AMCI 1,000 or 1,800 turn transducer
 ((Number of Turns) * 1,024) if Autotech Transducer

Range: 2 to Default Value



NOTE Programming this parameter will reset the Circular Offset, Linear Offset, and Preset Value parameters to their default values. Programming the Resolver Type, Transducer Type, or Number of Turns parameters resets this parameter to its default value.

Counts per Turn Data: Display Only.



Figure 2.12
Counts per Turn

This display shows the calculated Counts per Turn. It is for the users reference only and cannot be changed. Its value is (Full Scale Count / Number of Turns).



Setup Parameters (continued)

Circular Offset: Transducer Setup Parameter, Pg. 14

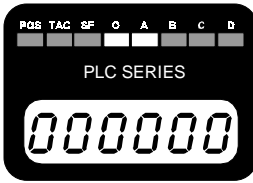

Figure 2.13
Circular Offset

Default: 0

Range: 0 to (Full Scale Count - 1)



Programming the Resolver Type, Transducer Type, Number of Turns, or Full Scale Count parameters resets this parameter to zero.

Linear Offset: Transducer Setup Parameter, Pg. 15



Figure 2.14
Linear Offset

Default: 0

Range: 0 to (999,999 - (Full Scale Count - 1))



Programming the Resolver Type, Transducer Type, Number of Turns, or Full Scale Count parameters resets this parameter to zero.

Preset Value: Transducer Setup Parameter, Pg. 15



Figure 2.15
Preset Value

Default: 0

Range: 0 to (Full Scale Count - 1)



Programming the Resolver Type, Transducer Type, Number of Turns, or Full Scale Count parameters resets this parameter to zero.

Decimal Point: Transducer Setup Parameter, Pg. 15



Figure 2.16
Decimal Point

Default: 0

Range: 0 to 5 inclusive

Special: The [◀] and [▶] keys have no effect.



Programming the Resolver Type, Transducer Type, Number of Turns, or Full Scale Count parameters resets this parameter to zero.

Setup Parameters (continued)

The remaining displays are all Module Setup Parameters. For all of these displays, the [▲] and [▼] keys change the entire value, not one digit. The [◀] and [▶] keys have no effect.

Position Format: Module Setup Parameter, Pg. 16

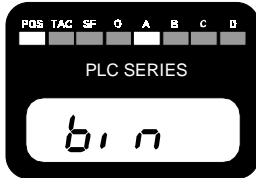

Figure 2.17
Position Format

Default: Binary format
Range: Binary
BCD

Transfer Type: Module Setup Parameter, Pg. 16

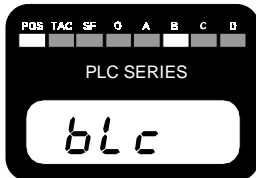

Figure 2.18
Transfer Type

Default: Block transfers
Range: Block
Single



You must cycle power to the module after changing this parameter.

PLC Program: Module Setup Parameter, Pg. 17

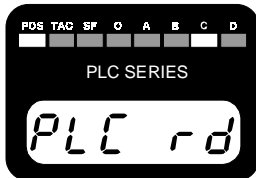

Figure 2.19
PLC Program

Default: Read Only
Range: Read Only
Programming Enabled



- 1) This parameter is only shown when the Transfer Type parameter is set to block transfer.
- 2) You must cycle power to the module after changing this parameter.

Error Messages

There are three types of faults that the 1761 or 1762 module will recognize.

- **Transducer Fault (Error 1)** - A problem exists on a transducer channel.
- **nvRAM Fault (Error 2)** - A problem exists with the non-volatile RAM or parameter values are not stored correctly.
- **Reference Voltage Fault** - The reference voltage constants could not be automatically restored while clearing a nvRAM error.

In all cases, the red FAULT LED will be on and the module will display an error message as shown below. These errors are also reported over the backplane. See *Block Transfer Data Format*, page 45, *Single Transfer Data Format*, page 46, or *Status, Position and Tachometer Data*, page 53, for information on how these errors are reported over the backplane.

Transducer Fault (Error 1)

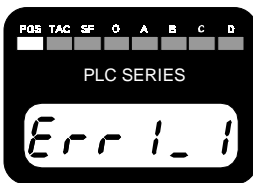

Figure 2.20
Transducer Fault

This message is only shown when the module is displaying position or tachometer data. The parameters are displayed normally. Figure 2.20 shows the display for an error on channel 1. If the error is on channel 2 the display will be “Err1_2”. If there is a transducer fault on both channels the display will read “Err1_b”. If the FAULT LED is on while the position is displayed, the fault is on the other channel. Use the [NEXT] key to switch to the faulted channel. The fault can be cleared by pressing the [CLEAR] key if the 'Err1' message is blinking. There are six major causes of a transducer fault.

- Broken or intermittent transducer cable
- Non-compatible transducer
- Improper wiring of the transducer cable
- Improper installation of the transducer cable
- Faulty transducer
- Faulty module

nvRAM Fault (Error 2)

All of the parameters are stored in a non-volatile static RAM memory when power is removed from the module. The nvRAM has an integral lithium battery that will maintain the parameter values in the absence of power for approximately ten years from the date of manufacture. It is remotely possible that the values can become corrupted through electrical noise or an inopportune power outage. If this occurs, the modules display will change to figure 2.21.

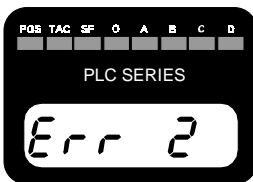

Figure 2.21
nvRAM Error

This message is displayed at all times. This error can be cleared by pressing the [CLEAR] key. If the message remains after pressing the [CLEAR] key, the nvRAM is damaged. If the message appears on every power up but can be cleared, the battery is discharged. In either case, the module must be returned to AMCI for repairs. See the inside front cover, *Returns Policy*, for additional information.

The 1761 and 1762 modules store constants in the nvRAM that allow it to adjust the reference voltage for either AMCI or Autotech transducers. If these constants are corrupted, the module will recalculate them as long a working transducer is attached. While calculating the constants, the display will show “rEF_nn” where nn = 00 to 99. Once recalculated, the display will change to the position display. If these constants could not be calculated, the display will change to the reference voltage fault display.

Error Messages (continued)

Reference Voltage Fault

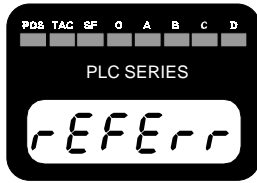

Figure 2.22
Transfer Type

The 1761 and 1762 modules store adjustment constants in the nvRAM memory that allow it to set the reference voltage for either AMCI or Autotech transducers. Usually, these constants can be restored automatically when a nvRAM fault is cleared. If the restoration fails, the module displays this “reference error” message. Make sure a working transducer is properly attached to the module and press the [CLEAR] key. The module will then recalculate the constants. If the message remains after pressing the [CLEAR] key, contact AMCI. See the inside front cover, [24 Hour Technical Support Number](#), for more information on contacting AMCI.

Transducer Input Connector

The transducer input connector of the 1761 has eight contacts while the connector of the 1762 has fourteen contacts. The following table lists the AMCI and Phoenix Contact part numbers of the mating connectors, which are included with every module shipped from the factory.

	8 Pin Connector	14 Pin Connector
AMCI Part #	MS-8	MS-14
Phoenix Part #	MSTB2.5/8-ST-5.08 1757077	MSTB2.5/14-ST-5.08 1757132

Table 2.1 Transducer Input Connector

Figure 2.23 shows the pinout to industry standard resolver wire designations. Cabling information for AMCI and Autotech transducers is given in chapter 3, starting on page 34, [Transducer Cable Installation](#).

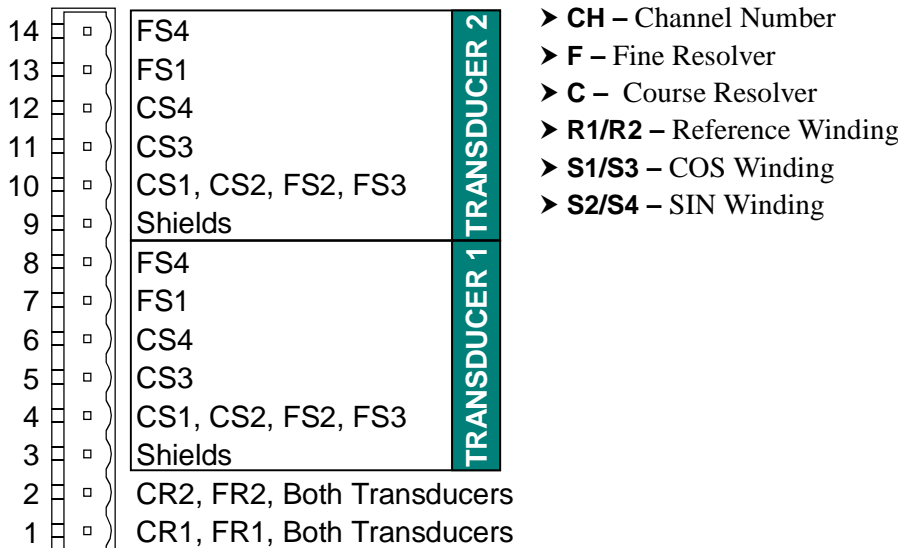

Figure 2.23 Transducer Input Connector



GC-1 Ground Clamp

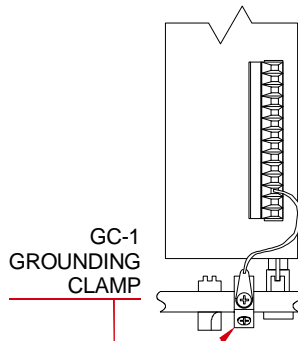

Figure 2.24 GC-1 Clamp

The shield of the transducer cable must be attached to the chassis with a GC-1 Ground Clamp. This guarantees a low impedance path to ground for any EMI radiation that may be induced into the cable. Without it, noise from the cable may affect the operation of the 1761, 1762, or the system as a whole.

The drain wire from the grounding clamp must be connected to pin 3 of the MS-8 or MS-14 Transducer Input Connector. Pin 9 of the MS-14 connector, which is the shield connections of the second transducer, is internally connected to pin 3 and does not need an additional wire. The grounding clamp package includes installation instructions.

CHAPTER 3

INSTALLATION

This chapter describes how to install the 1761 or 1762 module into the I/O chassis. It also give information on installing AMCI transducers. This includes information on transducer mounting, shaft loading, and cable installation. Information on interfacing Autotech transducers is also included.

Power Requirements

The 1761 and 1762 modules draw power from the I/O chassis +5Vdc supply. The maximum current draw is dependent on the number of transducer channels and is given in the table below. Add this to the power requirements of all other modules in the chassis when sizing the chassis power supply.

Model Number	1761	1762
Maximum Current Draw	700 mA	750 mA

Table 3.1 Backplane Current Draw

Installing the Module



WARNING

Remove system power before removing or installing any module in an I/O chassis. Failure to observe this warning may result in damage to the module's circuitry and/or undesired operation with possible injury to personnel.

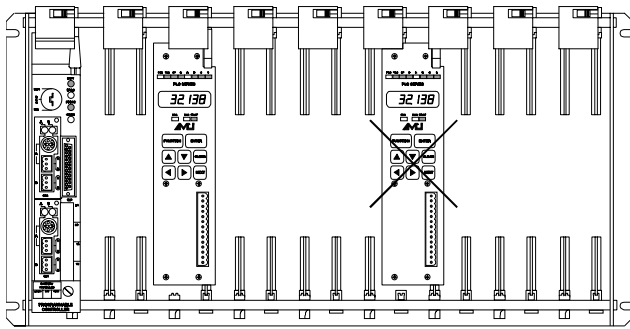

Figure 3.1 Module Installation

Install the module in a single slot pair within the chassis. A slot pair is two adjacent backplane slots, the left of which is even numbered. Most A-B chassis have the slots numbered on the backplane silk-screen. Figure 3.1 shows two modules. The module on the left is installed correctly in a single slot pair while the module on the right is incorrectly installed in two slot pairs.

All addressing and programming examples in this manual assume that the module is installed in a single slot pair.

Keying Bands

Plastic keying bands can be inserted into the top backplane connector to prevent the insertion of other modules. Insert the bands between the following pins:

- Pins 28 and 30
- Pins 32 and 34.

Transducer Specifications

HTT-20, HTT-400, HTT425-F, & HTT425-T Transducers		HTT425 Motor Mount Transducers
Shaft Diameter 0.625"		Shaft Diameter0.250" or 10mm
Shaft Loading Radial: 400 lbs. max. Axial: 200 lbs. max.		Shaft LoadingRadial: 40 lbs. max. Axial: 20 lbs. max.
Starting Torque 8 oz.in. @ 25° C		Starting Torque1.5 oz.in. @ 25° C
Moment of Inertia 6.25 x 10 ⁻⁴ oz-in-sec ²		Moment of Inertia1.25 x 10 ⁻⁴ oz-in-sec ²
Enclosure HTT-20, 400: NEMA 4 HTT425: NEMA 4X		EnclosureNEMA 4 When properly installed
Environmental (All Transducers)		
Operating Temperature -20 to 125°C	Shock 50G's for 11 milliseconds	Vibration 5 to 2000 Hz @ 20 G's

Table 3.2 Transducer Specifications

Transducer Mounting

All AMCI resolver based transducers are designed to operate in the industrial environment and therefore require little attention. However, there are some general guidelines that should be observed to ensure long life.

- Limit transducer shaft loading to the following maximums:

	Radial Load	Axial Load
All 0.625" Shafts	100 lbs. (445 N)	50 lbs. (222.4 N)
All other Shafts	30 lbs. (133 N)	15 lbs. (66.7 N)

Table 3.3 Transducer Bearing Loads

- Minimize shaft misalignment when direct coupling shafts. Even small misalignments produce large loading effects on front bearings. It is recommended that you use a flexible coupler whenever possible.

Transducer Outline Drawings

Outline drawings for most of our transducers are available on our website, <http://www.amci.com>. The outline drawing of the HTT-20-(x) transducers is also available on the following page of this manual. If you are not using the standard HTT-20-(x) transducer and need the outline drawing, check our website first. If you cannot find it there, contact AMCI and we will fax you the appropriate information.

Transducer Outline Drawings (continued)

HTT-20-(x) Outline Drawing

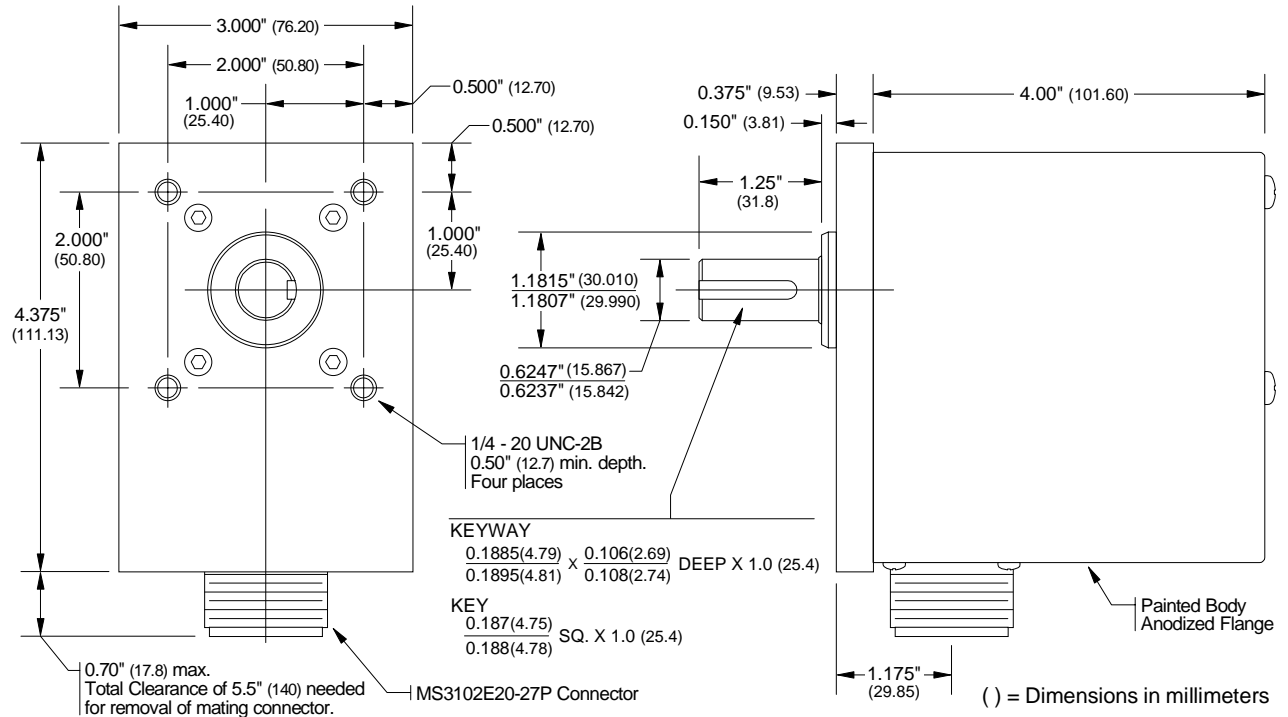

Figure 3.2 HTT-20-(x) Outline Drawing

Transducer Connector Pinout

All of the AMCI transducers that are compatible with the 1761 and 1762 modules have the same connector. Figure 3.3 is the connector pinout to the industry standard wire designations. Note that the HTT-400-180 has screw terminals and a conduit connection. It has resolver designations printed next to its connection terminals.

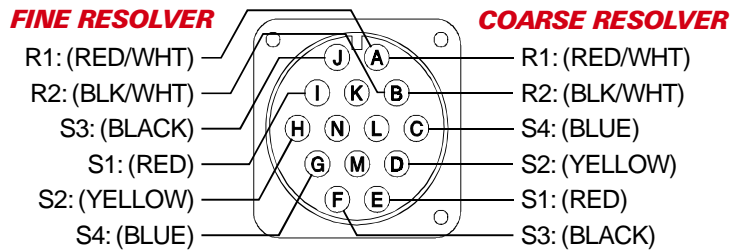

Figure 3.3 Transducer Connector Pinout

Transducer Cable Installation

Use the table below to determine the correct cable and connectors for your application. Cables that have the MS-20 transducer connector soldered to one end and the other end prepared are available from AMCI under the CML-(x) part number, where (x) is the length in feet. These cables are tested before they leave the factory. If you are making your own cables, cable and connectors can be ordered from AMCI.

Module	AMCI Part #	Belden Cable	Module Conn.	Transducer Conn.
1761	CML-(x) (2 req.)	9731	MS-8 (included w/ 1761)	MS-20 (1)
1762	CML-(x) (2 req.)	9731	MS-14 (included w/ 1762)	MS-20 (2)

Table 3.4 Transducer Cable Numbers

Not shown in the table is the GC-1 ground clamp. This clamp is required to properly ground the cable shields to the chassis that houses the 1761 or 1762 module. This clamp is shipped with each module. Additional AMCI.

NOTE 

- 1) Resolvers are low voltage, low power devices. If you are using A-B guidelines for cabling installation, treat the transducer cable as a Category 2 cable. It can be installed in conduit along with other low power cabling such as communication cables and low power ac/dc I/O lines. It cannot be installed in conduit with ac power lines or high power ac/dc I/O lines. Refer to the Allen Bradley *Automation Wiring and Grounding Guidelines*, Publication number 1770-4.1 for more information.
- 2) The shields of the transducer cable must be grounded at the module *only!* When installing the cable, treat the shield as a conductor. Do not connect the shield to ground at any junction box or the transducer. These precautions will minimize the possibility of ground loops that could damage the module or PLC.
- 3) To reverse the count direction, first reverse the connections of the GRN/BLK pair at the MS-8 or MS-14 connector. Then, reverse the connections of the BLU/BLK pair.

Transducer Cable Wiring Diagrams

1761 Wiring: CML-(x) to MS-8 and GC-1

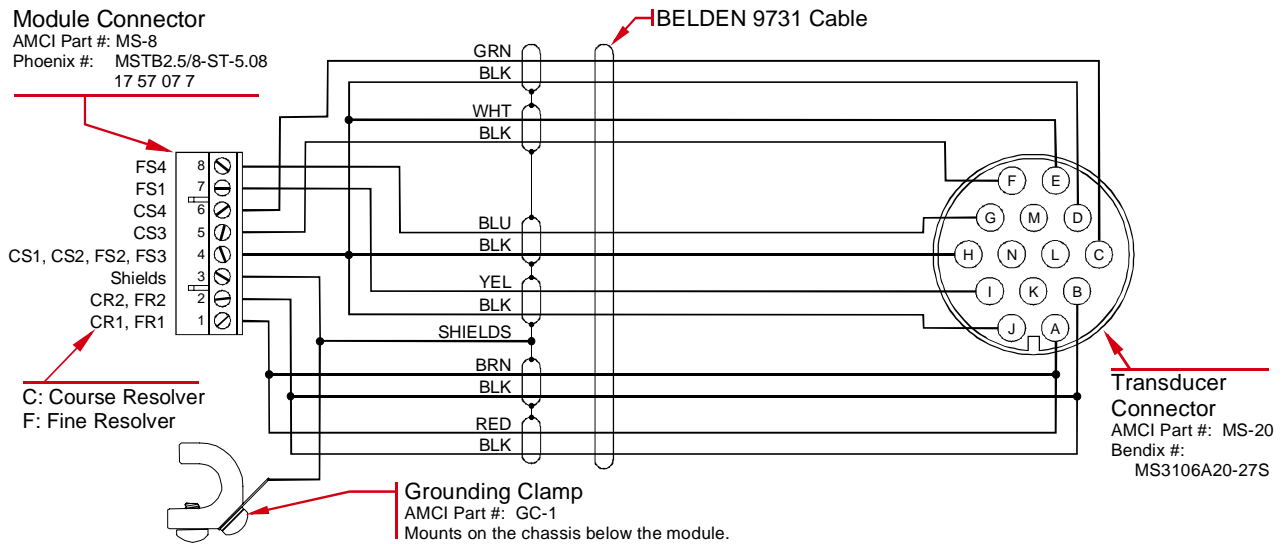

Figure 3.4 CML-(x) to MS-8 Wiring Diagram

Transducer Cable Wiring Diagrams (continued)

1762 Wiring: (2) CML-(x) to MS-14 and GC-1

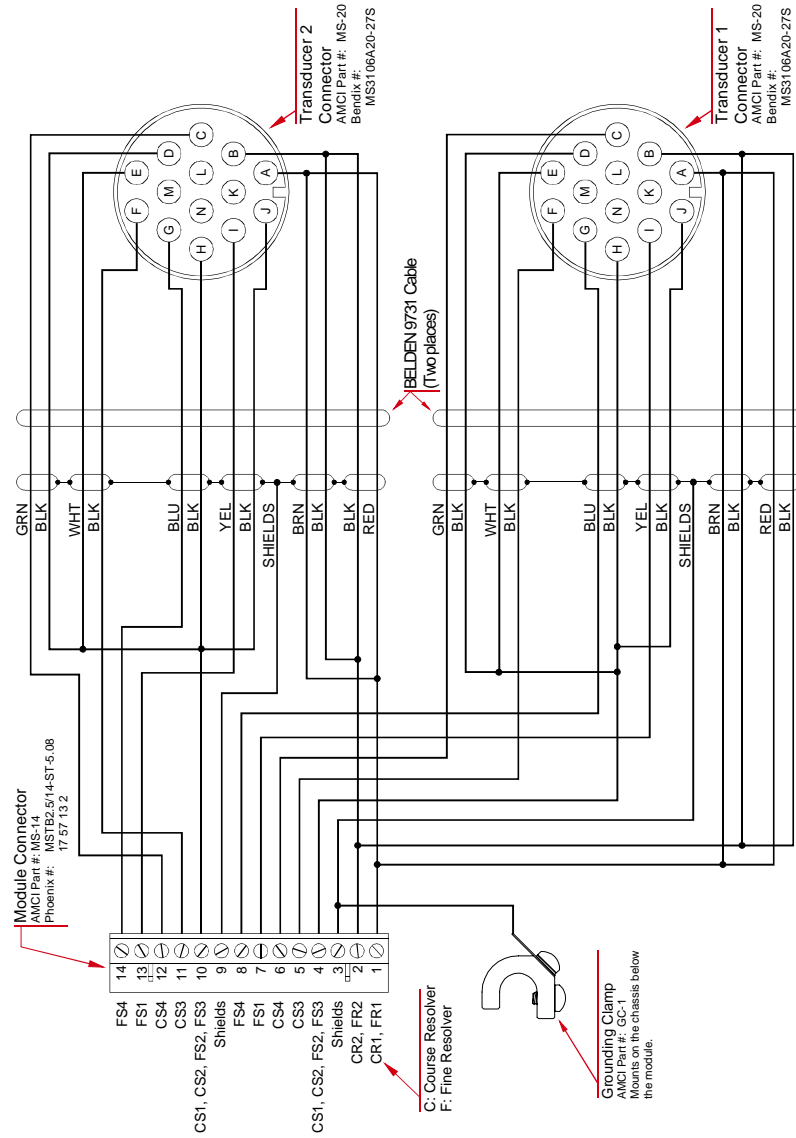

Figure 3.5 (2) CML-(x) to MS-14 Wiring Diagram

GC-1 Grounding Clamp

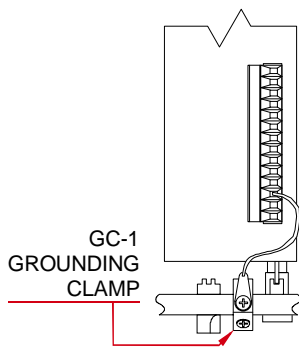

Figure 3.6 GC-1 Clamp

The shield of the transducer cable must be attached to the chassis with a grounding clamp (AMCI part number GC-1). This guarantees a low impedance path to ground for any EMI radiation that may be induced into the cable. The drain wire from the grounding clamp must be connected to pin 3 of the MS-8 or MS-14 Transducer Input Connector. Pin 9 of the MS-14 connector is internally connected to pin 3 and does not need an additional wire. The grounding clamp package includes installation instructions.

Autotech Transducer Installation

Supported Transducers

The 1761 and 1762 modules directly support Autotech SAC-RL210-G128 transducers. The Autotech SAC-RL210-G64 transducers are not supported by AMCI. Refer to Autotech literature for dimensional drawings and mounting recommendations. When using Autotech transducers, only 10 bit resolution, (1,024 counts per turn) is supported. If you need higher resolution in an Autotech package, AMCI offers the HTT-400-180 which is a direct bolt-in replacement for the Autotech RL210. AMCI strongly suggests using the HTT-400-180 transducer instead of the Autotech RL210 in all new installations.

Transducer Wiring

Table 3.5 is a wiring table for all supported Autotech transducers. The table cross references resolver designations, AMCI wire color, Autotech terminal and connector pin outs, and Transducer Input Connector pin out.

NOTE

- 1) Autotech CBL-10T22 cable is not supported. Belden 9731 or exact equivalent must be used.
- 2) Cable drawings for connecting Autotech transducers are available. If you want a cable drawing instead of using the table, contact AMCI. A drawing will be faxed to you upon request.

Resolver Designation ¹	9731 Wire Color	SAC-RL210 Terminals	SAC-RL210 MS Connector	1761 Connector	1762 Connector ³
R1	RED	1	A	1	1
R2	BLK/RED ²	2	B	2	2
R1	BRN	1	A	1	1
R2	BLK/BRN ²	2	B	2	2
CS1	WHT	3	C	6	12
CS3	BLK/WHT ²	5	E	4	10
CS2	BLK/GRN ²	4	D	5	11
CS4	GRN	6	F	4	10
FS1	YEL	7	H	4	10
FS3	BLK/YEL ²	9	L	8	14
FS2	BLK/BLU ²	8	K	4	10
FS4	BLU	10	M	7	13

1: F = Fine Resolver C = Coarse Resolver

2: Denotes black wire of black and colored wire pair.

3: Connections shown are for the second transducer. Connections for the first transducer are given in the 1761 Connector column.

Table 3.5 Autotech Transducer Wiring

CAUTION

Do not, under any circumstances, connect the shields of the transducer cable to the earth ground connection of the transducer. This connection could form a ground loop that may damage the 1700 module or PLC. The earth ground connection on the MS style connectors is pin G. The earth ground connection on the screw terminal transducers is the green screw.

MODULE ADDRESSING

This chapter explains how to address a 1761 or 1762 module in a PLC-5 programmable controller system. If you are using a PLC-2 or PLC-3, contact AMCI if you need assistance.

When you configure your programmable controller system, a unique address is assigned to each slot of each chassis in the system. The I/O Rack Number and I/O Group Number make up each address. A block transfer address is further specified with a Module Slot Number.

Note that an I/O Chassis is not the same as an I/O Rack. An I/O Chassis is the physical enclosure for the processor and I/O modules. An I/O Rack Number is part of a modules' address in the system. Each I/O Chassis can have ¼ to 4 I/O Racks associated with it.

Definition of Terms

Block Transfer

The transfer of a block of data over the backplane in one scan. A Block Transfer Read transmits data from an I/O module to the processor. A Block Transfer Write transmits data from the processor to an I/O module. Up to sixty-four words can be transmitted per block transfer.

Single Transfer

The transfer of a single unit (8, 16, or 32 bits) of data over the backplane. The transfer occurs between I/O modules and the processors' Input or Output Image Tables. A 1761 can be configured to transmit position data with 32 bit single transfers. These single transfers occur automatically every I/O scan and can occur during a program scan with the use of Immediate Input Instructions.

I/O Rack

The number of I/O Racks, not the number of chassis, define the programmable controller system. In PLC-5 systems the first I/O Rack is assigned the number 0. Each I/O Rack is further divided into 8 I/O Groups.

When specifying a block transfer or single transfer address, all I/O Rack and Group numbers are expressed in octal. (i.e. 00, 01, 02, ... 06, 07, 10, 11,)

I/O Group

An I/O Group consists of 16 input and 16 output bits. Eight I/O Groups, numbered 0 through 7, make up a single I/O Rack.

Slot Pair

Backplane slots of an I/O Chassis are numbered consecutively from zero starting at the left most *I/O slot*. The processor slot is not numbered. A slot pair is two adjacent backplane slots, the left of which is even numbered. Most A-B chassis have the slot numbers printed on the backplane.

The module must be installed in a single slot pair to operate properly. See *Installing the Module* on page 31 for more information. The figures in this chapter show the module in a single slot pair.

2-Slot Addressing

Two slot addressing assigns one I/O group to each slot pair in the chassis. Block transfers use the I/O group for control bits. You cannot use 32 bit single transfers if the chassis is configured with 2-slot addressing.

Definition of Terms (continued)

1-Slot Addressing

With 1-slot addressing, one I/O group (16 I/O bits) is assigned to each slot in the chassis. Therefore, the module has two I/O groups in its slot pair, one in each slot. Block transfers use the odd numbered I/O group for control bits. When using 32 bit single transfers, the upper three digits of the position data is at the even I/O group, the lower three digits of the position are at the odd I/O group. As an example, if the position is '123,456' then the even I/O group contains '123' and the odd I/O group contains '456'. If the position data equals '789', then the even I/O group equals '000' and the odd I/O Group contains '789'.

! CAUTION

The A-B backplane interface IC was designed primarily as a block transfer controller. Because of this, 32 bit single transfers with 1-slot addressing do not work with all processors. It is the users responsibility to test 32 bit single transfers in the system to determine if transfer operates correctly.

½-Slot Addressing

With ½-slot addressing, two I/O groups (32 I/O bits) are assigned to each slot in the chassis. Therefore the module has four I/O groups in its slot pair, two in each slot. The 1761 and 1762 modules do not use the first or second I/O groups. Block transfers use the third I/O group for control bits. When using 32 bit single transfers, the third I/O group contains the upper three digits of the position value and the fourth I/O group contains the lower three digits of the position data.

Addressing the 1761 or 1762 as a Block Transfer Module

When configured as a block transfer module, the processor reads data from the 1761 or 1762 with block transfer read (BTR) instructions. If enabled with the *PLC Program* parameter, the processor can program setup parameters and issue auxiliary commands with block transfer write (BTW) instructions.

The block transfer address is made up of four digits. They are the I/O Rack Number (two digits), the I/O Group Number (one digit), and the Module Slot Number (one digit).

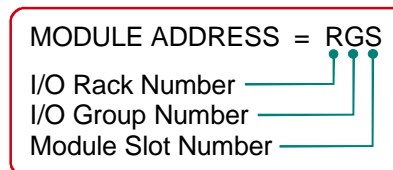

Figure 4.1 BT Module Address

Addressing Shortcuts

- Always base the address on the slot the PC Board plugs into.
- **2-slot address:** Slot number always equals one.
- **1-slot address:** Group number always odd, slot number always equals zero.
- **½-slot address:** Group number always even, slot number always equals zero.

Addressing the 1761 as a Single Transfer Module

Once a 1761 is configured correctly by setting the *Transfer Type* parameter, the processor reads position data with single transfers. To use this data, you must know the memory locations in the input image table associated with the module.

- **PLC-5 Input Table:** The characters "I:" followed by a three digit number. The first two digits are the I/O rack number, followed by the I/O group number.

Addressing Shortcuts

- **2-slot address:** Not Available
- **1-slot address:** Upper three digits of the position data at the even numbered I/O Group.
Lower three digits of the position data at the odd numbered I/O Group.

Example 1: Position Data = '123,456'
Even Group = '123'
Odd Group = '456'

Example 2: Position Data = '789'
Even Group = '000'
Odd Group = '789'

Because the A-B backplane interface IC is designed primarily for block transfer use, 32 bit transfers with 1-slot addressing does not work in all systems. Check operation before using this mode.

- **½-slot address:** Always base address on the slot the PC Board plugs into.
Upper three digits of the position data at the even numbered I/O Group.
Lower three digits of the position data at the odd numbered I/O Group.

Addressing Examples

The following are examples of module addressing for 2-slot, 1-slot and ½-slot configurations. The PLC-5 addresses for block and single transfers are also shown.

In the following figures, the module is placed in a single slot pair. See *Installing the Module* on page 31 for more information on installing the module.

2-Slot Addressing

Rack Number: 00
I/O Group Numbers: 4
Module Slot Number: 1

BT Address: 0041
ST Address: N/A

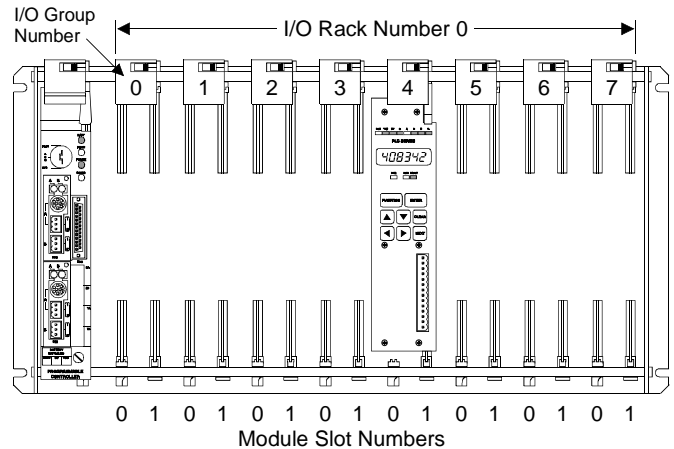

Figure 4.2 2-Slot Address Example

Addressing Examples (continued)

1-Slot Addressing

Rack Number: 01
I/O Group Numbers: 0,1
Module Slot Number: 0

BT Address: 0110
ST Upper Position Addr: I:010
ST Lower Position Addr: I:011

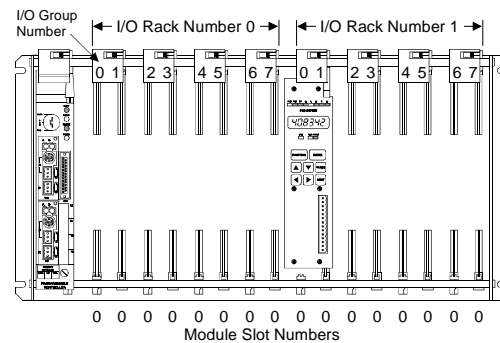

Figure 4.3 2-Slot Address Example

1/2-Slot Addressing

Rack Number: 02
I/O Group Numbers: 2,3
Module Slot Number: 0

BT Address: 0220
ST Upper Position Addr: I:022
ST Lower Position Addr: I:023

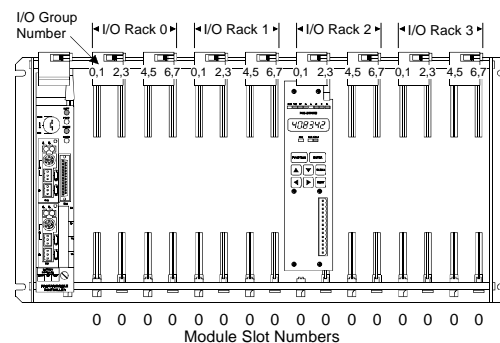

Figure 4.4 1/2-Slot Address Example

Restrictions and Warnings

- The 1761 or 1762 module must be installed in a single slot pair in order to operate properly. See [Installing the Module](#) on page 31 for more information on installing a module.
- The A-B backplane interface IC was designed primarily as a block transfer controller. Because of this, 32 bit single transfers with 1-slot addressing do not work with all processors. It is the users responsibility to test 32 bit single transfers in the system to determine if transfer operates correctly.
- When using a 1761 or 1762 module in a Remote I/O chassis, the I/O Adapter must be a 1771 - ASB, Series B, Firmware Rev. F, or later. A Remote I/O Adapter that has an earlier Series or Firmware Revision may not work properly with the module.
- If you change the *Transfer Type* or *PLC Program* parameters, you must cycle power to the module to re-initialize the A-B backplane interface IC.
- If your system presently uses a 1761 as a block transfer module and you are converting the module to a single transfer module, remember to remove all block transfer instructions that access the module. Block transfers use the I/O group bits for block transfer control. Therefore, block transfers can corrupt single transfer data.

WARNING

Do not configure the 1761 module to use single transfers when installing the module in a remote rack. Under some conditions, it is possible that the 32 bit data from the 1761 will be corrupted when it is read by the Remote I/O Adapter. This occurs due to limited handshaking between a Remote I/O Adapter and the 1761 which can result in the Remote I/O Adapter reading the 1761's data while the module is updating it. This form of data corruption cannot occur when the 1761 is in a local rack.

PLC-5 BLOCK TRANSFER INSTRUCTIONS

Overview

All PLC-5 processors have Block Transfer Instructions in their instruction sets. There are five parts to PLC-5 BT Instructions. They are:

- ▶ **Module Address** – The I/O rack, I/O group, and module slot numbers where the module is located.
- ▶ **Control Block** – The starting address of the five word block in memory that controls the Block Transfer.
- ▶ **Data File** – The starting address of the file that stores the data written to or read from the module.
- ▶ **File Length** – The number of words needed to store the data written to or read from the module.
- ▶ **Continuous Parameter** – Determines how often the block transfer is carried out.

Module Address

The Module address is the I/O rack, I/O group, and module slot numbers where the module is located in the system. These three numbers are entered separately in the block transfer instruction.

Control Block

The Control Block is a block of five words that control the actual transfer of data. The address entered into the BT instruction is the first address of the block. The control block must have an integer or BT data type and can be its own file or part of a larger file.

Each BT Instruction requires its own control block, even if multiple instructions access the same module.

Data File

The Data File is the block of words that stores information read from or written to the 1700 module. The Data Address is the address of the first word used in the file. The data file must have an integer or binary data type. It can be a separate file or part of a larger file.

File Length

Block Transfer Reads

The File Length is the number of words in your data file. When programming a BTR instruction, you can set the Block Length to 00. This will reserve 64 words in the PLC-5 memory, but the module will only transmit the number of words necessary. The number of words transmitted depends on the type of module and the value of the PLC Program parameter. Table 5.1 lists the number of words transferred based on module numbers and PLC Program value.

PLC Program	1761	1762
Read Only	3 words	6 words
Program Enabled	10 words	10 words

Table 5.1 1761/1762 Block Transfer Read Lengths

File Length (continued)

Block Transfer Writes

When programming a BTW instruction, you must use a length of ten words. You cannot use a file length of zero with a BTW instruction to a 1761 or 1762 module. If you do so, the module will issue an error message to the processor.

Continuous Parameter

The Continuous parameter controls how often the block transfer instruction is executed. When the continuous parameter is set to “NO”, the block transfer is executed only on a false to true transition on the rung. This means that a non-continuous block transfer can occur at most every other scan. When the continuous parameter is set to “YES”, the block transfer will occur when the BT instruction is first scanned and then every scan thereafter until an error in communication occurs.

Block Transfer Writes to a 1761 or 1762 module *must* have the Continuous Parameter set to NO. Continuously writing Program Instructions to the module may interfere with normal operation. **Block Transfer Reads** to a 1761 or 1762 module can have their Continuous Parameter set to “YES”.

Enable (EN), Error (ER), and Done (DN) Bits

Used to signal the start and finish of a block transfer, the processor sets the EN bit to start the transfer and after successfully completing the transfer the module sets the DN bit. If an error occurs in the transfer, the module will set the ER bit instead of the DN bit.

The EN, ER, and DN bits are located in the first word of the Control File. The EN Bit is bit 15, the ER Bit is bit 12 and the DN Bit is bit 13.

The following warning is taken verbatim from Allen-Bradley's PLC-5 Family Programmable Controllers Processor Manual, Publication 1785-6.8.2 - November, 1987 and refers to the control bits of the BT instruction. These bits include the Enable, Error, and Done bits.

“IMPORTANT: The processor executes block-transfer instructions asynchronous to the program scan. The status of these bits could change at any point in the program scan. When you test these bits (especially the done bit), test them only once every ladder program scan. If necessary, set temporary storage bits for the purpose of enabling subsequent rungs from them.

Also, your ladder program should condition the use of block transfer data on the examination of the block-transfer error bit. An error may occur when the processor is switched from run mode, or when processor communications are interrupted.”

Programming Example

The following example assumes 1-Slot addressing with a 1761 module in I/O Rack 2, I/O Groups 4 & 5 of the system.

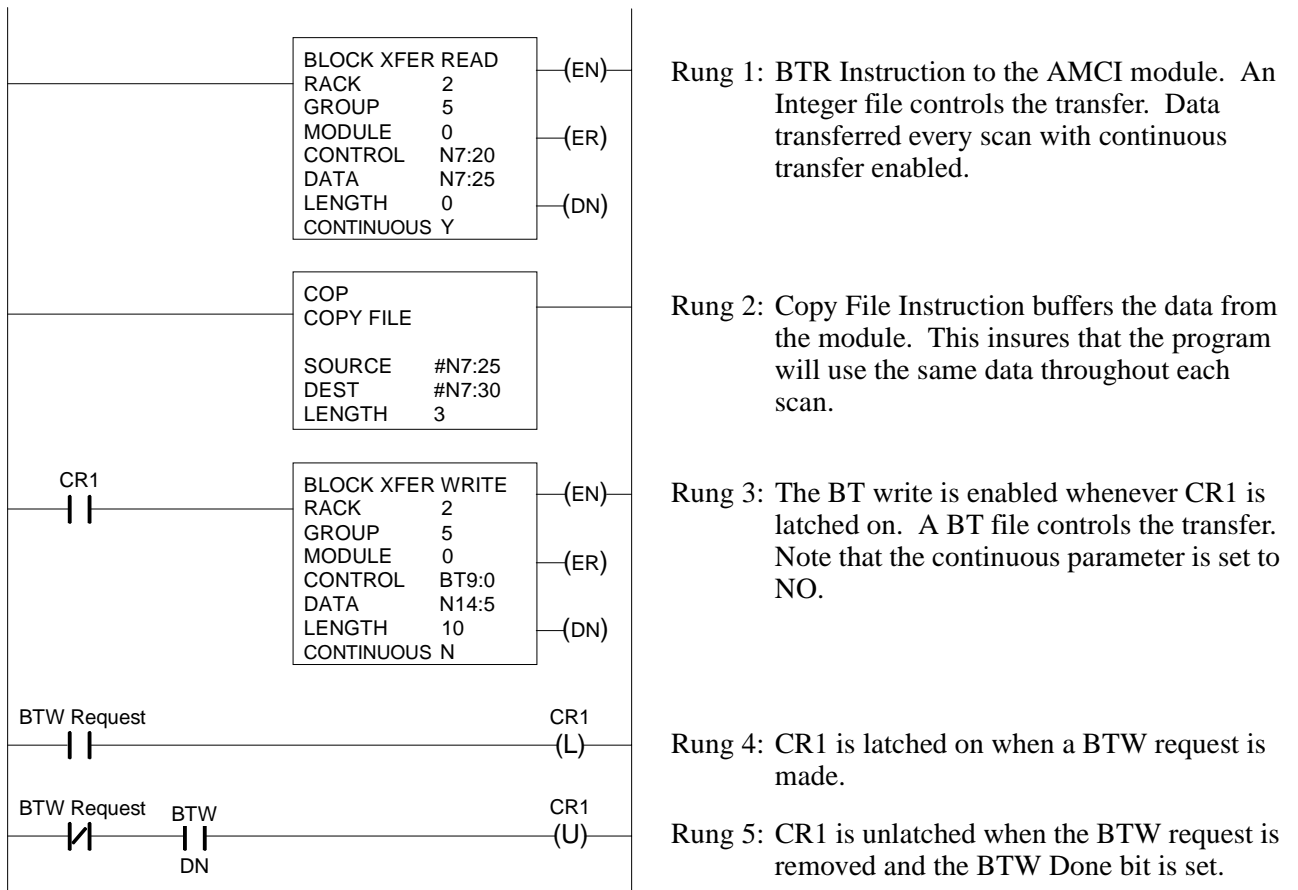

Figure 5.1 PLC-5 Programming Example

PLC-5 Restrictions and Warnings

- The 1761 or 1762 module must be installed in a single slot pair in order to operate properly. See *Installing the Module* on page 31 for more information on installing a module.
- When using a 1761 or 1762 module in a remote chassis, the Remote I/O Adapter must be a 1771 - ASB, Series B, Firmware Rev. F, or later. A Remote I/O Adapter that has an earlier Series or Firmware Revision may not work properly with the module.

! WARNING

Do not configure the 1761 module to use single transfers when installing the module in a remote rack. Under some conditions, it is possible that the 32 bit data from the 1761 will be corrupted when it is read by the Remote I/O Adapter. This occurs due to limited handshaking between a Remote I/O Adapter and the 1761 which can result in the Remote I/O Adapter reading the 1761's data while the module is updating it. This form of data corruption cannot occur when the 1761 is in a local rack.

- When the processor enables a block transfer, it puts all of the needed information into a queue. A queue is a data structure where the first piece of information put into the queue is the first piece of information taken out. Once the information is queued, a separate part of the processor performs the block transfer while the rest of the processor continues with the program scan. Each I/O rack in the system has its own queue. Each queue can hold 17 BT requests. When the block transfer has its Continuous bit set to 1, Continuous Parameter is "YES", the Block Transfer is placed permanently in the queue.

Each queue has a "Queue Full" bit in word 7 of the processor's status file. Bit 8 is for Rack 0, Bit 9 is for Rack 1, and so on up to bit 15 for Rack 7. The appropriate bit is set when a queue is full of BT Requests. Once set, your ladder logic program must clear these bits. We recommend that your program monitor these bits and take appropriate action if these bits are set.

If you have more than 17 block transfers associated with one rack and you set all of their continuous parameters to YES, only the first 17 block transfers scanned will be performed. All other transfers cannot be put into the queue and will never be performed.

CHAPTER 6

DATA FORMAT

This chapter covers the format of the position and tachometer data sent from a 1761 or 1762 module when it is not programmable from the backplane. This occurs when you are using single transfers or you are using block transfers and the PLC Program parameter is set to *Read Only*.

Refer to chapter 7, **BACKPLANE PROGRAMMING**, for information on the format of the position and tachometer data when the module is programmable from the backplane.

Block Transfer Data Format

When a block transfer read instruction accesses a 1761 or 1762 module, the module transmits three 16 bit words for each transducer channel. The format of the data is shown in the figure below.

1761	
Word 0	E* Upper Three Digits of Position Data
Word 1	Lower Three Digits of Position Data
Word 2	E* Tachometer Data

1762	
Word 0	E* Upper Three Digits of Position Data, CH.1
Word 1	Lower Three Digits of Position Data, CH.1
Word 2	E* Tachometer Data, CH.1
Word 3	E* Upper Three Digits of Position Data, CH.2
Word 4	Lower Three Digits of Position Data, CH.2
Word 5	E* Tachometer Data, CH.2

Figure 6.1 BTR Data Format

- E* Error bit.** When there is a transducer, nvRAM, or reference voltage fault, the module transmits 8000h (1000 0000 0000 0000b) in the upper position and tachometer data words. The lower position word is set to zero. This is the only time the most significant bit of the upper position data word is set. If the error is a transducer fault, only the words of the faulted channel are changed. If the error is a nvRAM or reference voltage fault, all of the data words are changed.
- The position data is broken down into two words because it can be greater than 32,767 (15 bits). The thousands digits are transmitted in the first word and the hundreds, tens, and ones digits are transmitted in the second word. For example, the position '123,456' would be transmitted as '123' in the first word and '456' in the second word.
- 1761 and 1762 modules transmit position data in binary or BCD format. The Position Format parameter sets the format of this data. See page 16 in chapter 1, **Position Format** for more information on this parameter.
- Tachometer data is always transmitted in binary.

Single Transfer Data Format

A 1761 module can be configured to transmit its position data with single transfers by setting its Transfer Type parameter to *single transfer*. Tachometer data is not available. The single transfer length is always 32 bits.

Chapter 4, **MODULE ADDRESSING**, contains information on where the position data is located in the Input Image Table.

1761 Single Transfer Data		
Word 0	E*	V* Upper Three Digits of Position Data
Word 1	Lower Three Digits of Position Data	

Figure 6.2 Single Transfer Data Format

- E* Error bit.** When there is a transducer, nvRAM, or reference voltage fault, the module transmits 8000h (1000 0000 0000 0000b) in the upper position data word. The lower word is set to zero. This is the only time the most significant bit of the upper position data word is set.
- V* Velocity at Zero bit.** When the tachometer data equals zero for a minimum of 250 milliseconds this bit is set. This bit is reset as soon as the velocity data becomes non-zero. This bit is included to make the 1761 compatible with the older 1761-10 modules.
- Position data is transmitted in Binary or BCD format. The Position Format parameter sets the format of this data. See **Position Format** on page 16 for more information on this parameter.

WARNING

Do not configure the 1761 module to use single transfers when installing the module in a remote rack. Under some conditions, it is possible that the 32 bit data from the 1761 will be corrupted when it is read by the Remote I/O Adapter. This occurs due to limited handshaking between a Remote I/O Adapter and the 1761 which can result in the Remote I/O Adapter reading the 1761's data while the module is updating it. This form of data corruption cannot occur when the 1761 is in a local rack.

This chapter describes the format of the data written to and read from a 1761 or 1762 using BTW and BTR instructions when the module is programmable from the backplane. It assumes familiarity with the setup and operation of the module. Descriptions of the modules' parameters given in chapter 1 are not repeated here. However, the default, minimum and maximum values that can be programmed are listed.

You must set the *Transfer Type* parameter to *block transfers* and the *PLC Program* parameter to *program enabled* before backplane programming is enabled. See pages 16 and 17 in chapter 1 as well as page 27 in chapter 2 for more information on setting these parameters.

If you have decided to leave the module non-backplane programmable or are using single transfers, refer to chapter 6 for information on the modules data format when using either of these modes.

Block Transfer Writes

In addition to the keyboard, all Transducer Setup parameters and two of the Module Setup parameters can be programmed with block transfer writes (BTW). Programming from the keyboard can also be disabled. Follow these guidelines when using block transfer writes.

- ▶ BTW length is always 10 words. Do not set the length to zero when programming the BTW. Any unused words in the block transfer should be considered reserved and must be set to zero. If a reserved word is not set to zero the module will respond to the BTW with an *Invalid Command* error.
- ▶ Most of the Transducer Setup parameters can exceed 32,768. Therefore each parameter require two words to hold its value. The thousands digits must be transferred in the first word, the ones, tens, and hundreds digits must be transferred in the second word. For example, a Full Scale Count of 368,640 would be transferred as 368 in the first word and 640 in the second word.
- ▶ Once a block transfer write to the module has completed, (i.e. The DONE Bit is set), perform a block transfer read to input the status, position and tach data of the module. Check the error bits and take appropriate action if an error has occurred.

NOTE

If there is an error in the data sent to the module, it responds by setting the appropriate error bits and ignores all of the data sent to it with the block transfer write.



BTW Command Word

The first word of a BTW is the Command Word. As shown in figure 7.1, setting one of the upper four bits of the Command Word tells the 1761 or 1762 which parameters are transferred in the remaining nine words. Note that only one bit can be set per block transfer. The meaning of the rest of the bits in the Command Word changes, and is explained in the following sections.

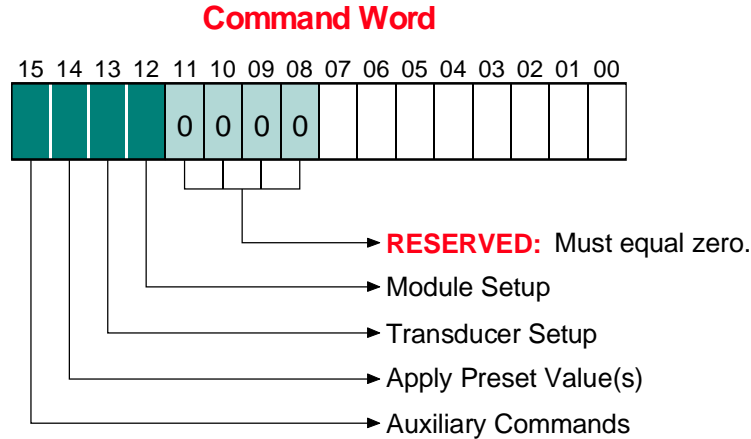

Figure 7.1 Command Word Format

Module Setup Command

When the Module Setup bit (bit 0/12) of the Command Word is set, the 1761 or 1762 uses bits in the lower byte of the Command Word to program the Resolver Type and Position Format parameters. The format of the Module Setup Command Word is shown below.

Words 1 through 9 are not used but must be transmitted. They should be considered reserved for future use and must be set to zero.

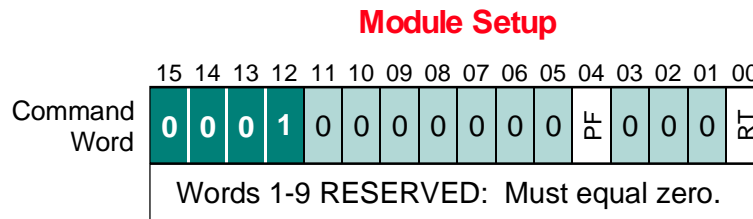

Figure 7.2 Module Setup Command Data Format

Programming Bit Values

RT: Resolver Type Bit: 0/00. Set to 0 to program the Resolver Type to AMCI transducers, *Resolver Type 1*. Set to 1 to program the Resolver Type to Autotech transducers, *Resolver Type 2*.

PF: Position Format Bit: 0/04. Set to 0 to read the Position data in *Binary* format. Set to 1 to read the Position data in *BCD* format.

NOTE The Position Format bit also defines how the data of the Transducer Setup Command is interpreted. If the Position Format is set to Binary, then the Transducer Setup data sent to the module must also be in binary. If the Position Format parameter is set the BCD, then the Transducer Setup data sent to the module must also be in BCD.



Transducer Setup Command

When the Transducer Setup bit, (bit 0/13) of the Command word is set, the 1761 or 1762 uses the rest of the data to configure the transducer specified by the LSB of the Command Word. Configuring both transducers of a 1762 requires two block transfers. The Transducer Setup Command programs the parameters shown below. The data format is shown in figure 7.3.

- Count Direction ➤ Transducer Type ➤ Decimal Point
- Number of Turns ➤ Full Scale Count ➤ Circular Offset
- Linear Offset ➤ Preset Value

Transducer Setup Command

	15	14	13	12	11	10	09	08	07	06	05	04	03	02	01	00
Word 0	0	0	1	0	0	0	0	0	0	Decimal Point	TType	CDIR	ChNm			
Word 1	Number of Turns															
Word 2	Upper 1, 2 or 3 digits: Full Scale Count															
Word 3	Lower 3 digits: Full Scale Count															
Word 4	Upper 1, 2 or 3 digits: Circular Offset															
Word 5	Lower 3 digits: Circular Offset															
Word 6	Upper 1, 2 or 3 digits: Linear Offset															
Word 7	Lower 3 digits: Linear Offset															
Word 8	Upper 1, 2 or 3 digits: Preset Value															
Word 9	Lower 3 digits: Preset Value															

Figure 7.3 Transducer Setup Command Format

Programming Bit Values

- ChNm: Channel Number Bit: 0/00.** Set to '0' to program transducer channel one or set to '1' to program transducer channel two.
- CDIR: Count Direction Bit: 0/01.** Set to '0' if you want the position count to increase with a clockwise rotation of the transducer shaft or set to '1' if you want an increase with a counter-clockwise rotation.
- TType: Transducer Type Bits: 0/02-03.** Bits two and three are used to define the type of transducer on the input channel. The choices available is dependent on the value of the Resolver Type parameter.

Bit #		Resolver Type	
3	2	AMCI (Type 1)	Autotech (Type 2)
0	0	100 turn transducer	128 turn transducer
0	1	180 turn transducer	Reserved
1	0	1,000 turn transducer	Reserved
1	1	1,800 turn transducer	Reserved

Table 7.1 Transducer Type Bit Patterns



Transducer Setup Command (continued)

Programming Bit Values (continued)

Decimal Point: Bits 0/04-06: These three bits define a binary number that sets the number of digits to the right of the decimal point on the front panel display. This parameter has no effect on the data transmitted over the backplane.

Bit #			
5	4	3	
0	0	0	= 0 (xxxxxx)
0	0	1	= 1 (xxxxx.x)
0	1	0	= 2 (xxxx.xx)
0	1	1	= 3 (xxx.xxx)
1	0	0	= 4 (xx.xxxx)
1	0	1	= 5 (x.xxxxx)
1	1	0	Undefined
1	1	1	Undefined

Table 7.2 Decimal Point Bit Patterns

Ranges and Factory Default Values

Parameter	Range	Factory Default
Transducer Type	100, 180, 1,000, 1,800, or 128 Turn Transducer	100 Turn
Count Direction	CW increasing, CCW increasing.	CW increasing
Decimal Point	0 to 5 inclusive	0
Number of Turns	100 Turn: 1, 2, 4, 5, 10, 20, 25, 50 or 100 180 Turn: 1, 2, 3, 4, 5, 6, 9, 10, 12, 15, 18, 20, 30, 36, 45, 60, 90 or 180 1,000 Turn:(Any 100 turn value) * 10 1,800 Turn:(Any 180 turn value) * 10 128 Turn: 1, 2, 4, 8, 16, 32, 64, 128	100
Full Scale Count	2 to (# of Turns * 4,096) if AMCI 100 or 180 Turn 2 to (# of Turns * 409.6) if AMCI 1000 or 1800 Turn 2 to (# of Turns * 1,024) if Autotech Transducer	409,600
Circular Offset	0 to (Full Scale Count - 1)	0
Linear Offset	0 to (999,999 - (Full Scale Count - 1))	0
Preset Value	0 to (Full Scale Count - 1)	0

Table 7.3 Transducer Setup Parameter Values

NOTE

The Position Format parameter, which is programmed with the *Module Setup Command*, also defines how the data of the Transducer Setup Command is interpreted. If the Position Format is set to *Binary*, then the Transducer Setup data must be in binary. If the Position Format parameter is set the *BCD*, then the Transducer Setup data must be in BCD. The format of the *Module Setup Command* is given on page 48.



Apply Preset Value Command

When the Apply Preset Value bit, (bit 0/14) the Command Word is set, the 1761 or 1762 presets the position of one or both of the transducers. This is accomplished by calculating the Circular Offset needed to change the transducer position count to the Preset Value.

Words 1 through 9 are not used, but must be transmitted. These words should be considered reserved for future use and must be set to zero. The data format for Preset Transducer Position is show in figure 7.4.

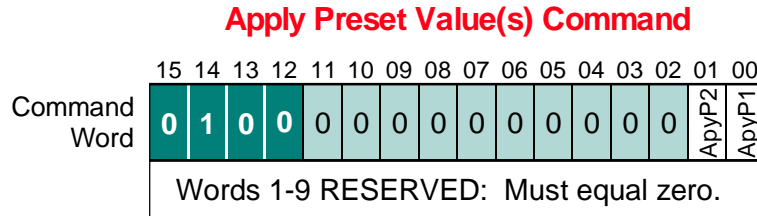

Figure 7.4 Preset Position Command Format

Programming Bit Values

ApyP1: Apply Preset Transducer 1 Bit: (0/00). Set this bit to '1' to adjust the position count of channel one to its programmed Preset Value.

ApyP2: Apply Preset Transducer 2 Bit: (0/01). Set this bit to '1' to adjust the position count of channel two to its programmed Preset Value.

- NOTE**
- 1) Both transducers can be preset with one command.
 - 2) This command only presets the position value. It does not program the value assigned to the Preset Value. The Preset Value is programmed with the *Transducer Setup Command*. See page 49 for more information on programming the Preset Value.

Auxiliary Commands

When the Auxiliary Commands bit, (bit 0/15) of the Command Word is set, the module uses bits 0 through 6 of the Command Word as data. Auxiliary Commands include clearing errors, enabling or disabling keyboard programming and defining the data transmitted to the processor with block transfer reads. Format of the block transfer read data is defined starting on page 53 in the section: *Block Transfer Reads*.

Words 1 through 9 are not used but must be transmitted. These words should be considered reserved for future use and must be set to zero. The data format for Auxiliary Commands is show in figure 7.5.

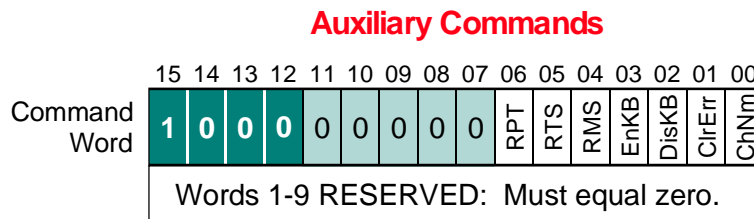

Figure 7.5 Auxiliary Commands Format



Auxiliary Commands Data (continued)

Programming Bit Values

ChNm: Channel Number Bit: (0/00). It is used with the RTS bit (0/05). The RTS bit is described below. The 1761 and 1762 have the ability to send the values of its backplane programmable parameters back to the PLC. If you have a 1762, set this bit to '0' to read back the Transducer Setup parameters of channel one or set this bit to '1' to read back the parameters of channel two. If you are using a 1761 and set this bit, a *Command Error* will result.

ClrErr: Clear Errors Bit: (0/01). Set to 1 to clear module and programming errors. These include:

- Transducer Faults
- All Programming Errors

NOTE  A NvRAM error can only be cleared from the keyboard.

DisKB: Disable Keyboard Bit: (0/02). Set this bit to 1 to disable all programming from the front panel. Parameters can be monitored from the keyboard but they cannot be changed. This bit does not have to be set continuously to disable keyboard programming. The status of the keyboard is retained by the 1761 and 1762 when power is removed. Therefore, the only way to enable the keyboard once the Disable Keyboard Command is accepted is with the *Enable Keyboard* bit, (Bit 0/03).

EnKB: Enable Keyboard Bit: (0/03). Set this bit to 1 to counteract a previous *Disable Keyboard* command.

RMS: Read Module Setup Bit: (0/04). Set this bit to 1 to read back the Resolver Type and Position Format parameters.

RTS: Read Transducer Setup Bit: (0/05). Set this bit to 1 to read back the *Transducer Setup* parameter values of the transducer specified by the *Channel Number* bit. (See *ChNum* bit above.)

RPT: Read Position and Tachometer Bit: (0/06). Set this bit to 1 to read back status, position and tachometer data of the transducers.

NOTE  1) If both of the DisKB and EnKB bits are set when a BTW is initiated, the module will respond with a *Command Error*.

2) One, and only one of the RMS, RTS, and RPT bits must be set when transmitting this command. Setting more than one, or none, will cause a *Command Error*.



Block Transfer Reads

Use block transfer reads to transfer module status data to the processor. The block transfer is always ten words long. The block transfer data takes one of three forms.

- Status, Position and Tachometer data
- Module Setup data
- Transducer Setup data.

On power up, the module transmits status, position and tachometer data. Use the *Auxiliary Commands* command with the RMS bit, (0/04), or the RTS bit, (0/05), set to read the other types of data. Use the RPT bit, (0/06) to switch back to the status, position and tachometer data. (For a full description of the *Auxiliary Commands*, see Pg. 51.)

Status, Position and Tachometer Data

The format of the status, position and tachometer data is shown in figure 7.6. This data is sent on power up, or when a BTW sends an Auxiliary Command to the 1760 with the RPT bit set. (Bit 0/06.) Words 0 through 3 contain the data of transducer one. Words 4 through 7 contain the data of transducer two. Word 0 is the status bits of transducer 1. Word 4 is the status bits of transducer 2. Words 1- 3 contain the position and tachometer data of transducer 1. Words 5-7 contain the position and tachometer data of transducer 2. Words 8 and 9 are always equal zero. If you are using a 1761, words 4-7 are always set to zero.

Status, Position and Tachometer Data

	15	14	13	12	11	10	09	08	07	06	05	04	03	02	01	00
Word 0	0	0	0	0	Programming Errors		0	0	0	0	0	0	0	0	0	E*
Word 1	E* Upper 1, 2 or 3 digits: Position 1															
Word 2	Lower 3 digits: Position 1															
Word 3	E* Tachometer 1															
Word 4	0	0	0	0	Programming Errors		0	0	0	0	0	0	0	0	0	E*
Word 5	E* Upper 1, 2 or 3 digits: Position 2															
Word 6	Lower 3 digits: Position 2															
Word 7	E* Tachometer 2															
Word 8	Not used. This word is always 0000h.															
Word 9	Not used. This word is always 0000h.															

Figure 7.6 Status, Position, and Tachometer Data Format



The position data is transferred in two words because it can be greater than 32,768. The first word contains the thousands digits while the second word contains the hundreds, tens, and ones digits. The Position Format parameter defines the format of the position data. The position data can be transmitted in *Binary* or *BCD* format. The tachometer data is always transmitted in binary.



Status, Position and Tachometer Data (continued)

Status Bit

E*: **Hardware Error Bits: (1/15, 3/15, 5/15, 7/15).** Set under the following conditions:

- **Transducer Fault (Error 1)** (See page 28 for a description of the fault.)
- **Reference Voltage Fault** (See page 29 for a description of the fault.)

NvRAM faults are not reliably transmitted when the module is programmable from the backplane. This is because the module defaults to read only mode when there is a nvRAM fault. If you specify a block transfer read length of ten words and the module experiences a nvRAM fault, the block transfer will stop working. If you specify a block transfer read length of zero word and the module experiences a nvRAM fault, the number of transmitted words will change from ten words to either three words (1761) or six words (1762). See chapter 6, **Block Transfer Data Format** on page 45 for more information on the format of the block transfer read data when the module is in block transfer read only mode.

Programming Error Bits: Bits 11 - 8

0000: No Errors

All data was accepted.

0001: Invalid Message Length

The BTW length was not set to ten words.

0010: Preset Error

An error exists in your *Apply Preset Value Command*.

- 1) You attempted to preset a transducer that is in transducer fault.
- 2) You have a 1761 module and set the 'PS2' bit.

See page 51 for a description of the **Apply Preset Value Command**.

0011: Invalid Command

An error exists in your *BTW Command Word*.

- 1) More than one of the four most significant bits of the BTW Command Word were set.
- 2) One or more of the remaining twelve bits of the BTW Command Word are set incorrectly.
- 3) A reserved data word does not equal zero.

See page 48 for a description of the **BTW Command Word**.

0100: Invalid Channel Number

An error exists in your *Transducer Setup Command* or your *Auxiliary Command*.

- 1) You have a 1761 module and set the 'ChNm' bit.

See **Transducer Setup Command**, starting on page 49, or **Auxiliary Commands**, on page 51.

0101: Invalid Transducer Type

An error exists in your *Transducer Setup Command*.

- 1) The module is presently configured for an Autotech Transducer and your 'TType' bit pattern is not equal to '00'. If you were not expecting the module to be configured for Autotech transducers then an error exists in your **Module Setup Command**. See page 48 for a description of this command.

See page 49 for a description of the **Transducer Setup Command**.

0110: Invalid Decimal Point

An error exists in your *Transducer Setup Command*.

- 1) The three 'Decimal Point' bits specify a binary number greater than five.

See page 49 for a description of the **Transducer Setup Command**.



Status, Position and Tachometer Data (continued)

Programming Error Bits. Bits 11 - 8 (continued)

0111: Invalid Read Mode

An error exists in your *Auxiliary Commands*.

- 1) Zero, or more than one, of the 'RPT', 'RTS' and 'RMS' bits are set.

See page 51 for a description of the *Auxiliary Commands*.

1000: Invalid Number of Turns

An error exists in your *Transducer Setup Command*.

- 1) You did not set the 'Number of Turns' word to one of the values listed in [Table 7.3](#).
- 2) You did not specify the correct transducer with the 'TType' bits in the Command Word.
- 3) You entered the Number of Turns value in the wrong radix. You must enter the value in the radix specified by the Position Format parameter.

1001: Invalid Full Scale Count

An error exists in your *Transducer Setup Command*.

- 1) The Full Scale Count value is outside the range specified in [Table 7.3](#).
- 2) You did not split the Full Scale Count value into two words correctly.
- 3) You entered the two Full Scale Count words in the wrong radix. You must enter the value in the radix specified by the Position Format parameter.

See page 49 for a description of the *Transducer Setup Command*.

1010: Invalid Circular Offset

An error exists in your *Transducer Setup Command*.

- 1) The Circular Offset value is outside the range specified in [Table 7.3](#).
- 2) You did not split the Circular Offset value into two words correctly.
- 3) You entered the two Circular Offset words in the wrong radix. You must enter the value in the radix specified by the Position Format parameter.

See page 49 for a description of the *Transducer Setup Command*.

1011: Invalid Linear Offset

An error exists in your *Transducer Setup Command*.

- 1) The Linear Offset value is outside the range specified in [Table 7.3](#).
- 2) You did not split the Linear Offset value into two words correctly.
- 3) You entered the two Linear Offset words in the wrong radix. You must enter the value in the radix specified by the Position Format parameter.

See page 49 for a description of the *Transducer Setup Command*.

1100: Invalid Preset Value

An error exists in your *Transducer Setup Command*.

- 1) The Preset Value is outside the range specified in [Table 7.3](#).
- 2) You did not split the Preset Value into two words correctly.
- 3) You entered the two Preset Value words in the wrong radix. You must enter the value in the radix specified by the Position Format parameter.

See page 49 for a description of the *Transducer Setup Command*.

1101: Reserved

1110: Reserved

1111: Reserved



Module Setup Data

The format of the module setup data is given in figure 7.7. This data is sent when a BTW sends an *Auxiliary Commands* to the 1760 with the RMS bit set. (Bit 0/04.) The format is identical to the *Module Setup Command*, found on page 48, but has the additional Programming Error bits in word zero.

Module Setup Data

	15	14	13	12	11	10	09	08	07	06	05	04	03	02	01	00
Command Word	0	0	0	1	Programming Errors				0	0	0	1	0	0	0	1
Words 1-9 are always 0000h.																

Figure 7.7 Module Setup Data Format

NOTE The meaning of the Programming Error bits is given starting on page 54, **Programming Error Bits: Bits 11 - 8.**

Transducer Setup Data

The format of the transducer setup data is shown in figure 7.8. This data is sent when a BTW sends an *Auxiliary Commands* to the 1760 with the RTS bit set. (Bit 0/05.) The format is identical to the *Transducer Setup Command*, found starting on page 49, but has the additional Programming Error bits in word zero.

Transducer Setup Data

	15	14	13	12	11	10	09	08	07	06	05	04	03	02	01	00
Word 0	0	0	1	0	Programming Errors				0	Decimal Point	TType	CDIR	CINP			
Word 1	Number of Turns															
Word 2	Upper 1, 2 or 3 digits: Full Scale Count															
Word 3	Lower 3 digits: Full Scale Count															
Word 4	Upper 1, 2 or 3 digits: Circular Offset															
Word 5	Lower 3 digits: Circular Offset															
Word 6	Upper 1, 2 or 3 digits: Linear Offset															
Word 7	Lower 3 digits: Linear Offset															
Word 8	Upper 1, 2 or 3 digits: Preset Value															
Word 9	Lower 3 digits: Preset Value															

Figure 7.8 Transducer Setup Data Format

NOTE

- 1) The Position Format parameter sets the radix of the data echoed back. For example, if the Position Format parameter is set to *BCD*, the data in words 1 - 9 will be in BCD format.
- 2) The meaning of the Programming Error bits is given starting on page 54, **Programming Error Bits: Bits 11 - 8.**

CHAPTER 8

SAMPLE PLC-5 PROGRAM

The following ladder logic program is an example of how block transfer instructions can be used to read and program a 1761 or 1762.

The program shows how to read and buffer data from a backplane programmable 1761 or 1762 module, and how a single block transfer write instruction can be used to send various program instructions to the module.

Data Table Values

The data table values are given in figure 8.1.

Offset	0	1	2	3	4	5	6	7	8	9
N10:0	0	0	0	0	0	0	0	0	0	0
N10:10	0	0	0	0	0	0	0	0	0	0
N10:20	0	0	0	0	0	0	0	0	0	0
N10:30	-32766	0	0	0	0	0	0	0	0	0
N10:40	16385	0	0	0	0	0	0	0	0	0
N10:50	8244	180	737	280	0	0	0	0	123	456

Figure 8.1 Sample Program Data Values

N10:30 - 39 is an *Auxiliary Commands* programming block. The value of -32,766 (8002h) in N10:30 issues the Clear Errors command.

N10:40-49 is an *Apply Preset Value Command* programming block. The value of 16,385 (4001h) in N10:40 issues the Apply Preset Value for Transducer 1 command.

N10:50-59 is a *Transducer Setup Command* programming block. The values of 8,244 (2034h) in N10:50 and the data words in N10:51-59 program Transducer 1 as follows:

Parameter	Location	Value
Count Direction	N10:50/01	Positive
Transducer Type	N10:50/02-03	180 turn
Decimal Point	N10:50/04-06	3
Number of Turns	N10:51	180
Full Scale Count	N10:52-53	737,280
Circular Offset	N10:54-55	0
Linear Offset	N10:56-57	0
Preset Value	N10:58-59	123,456

Table 8.1 Sample Program Parameter Values

Ladder Logic

1760exam.rsp

LAD 2 - --- Total Rungs in File = 8

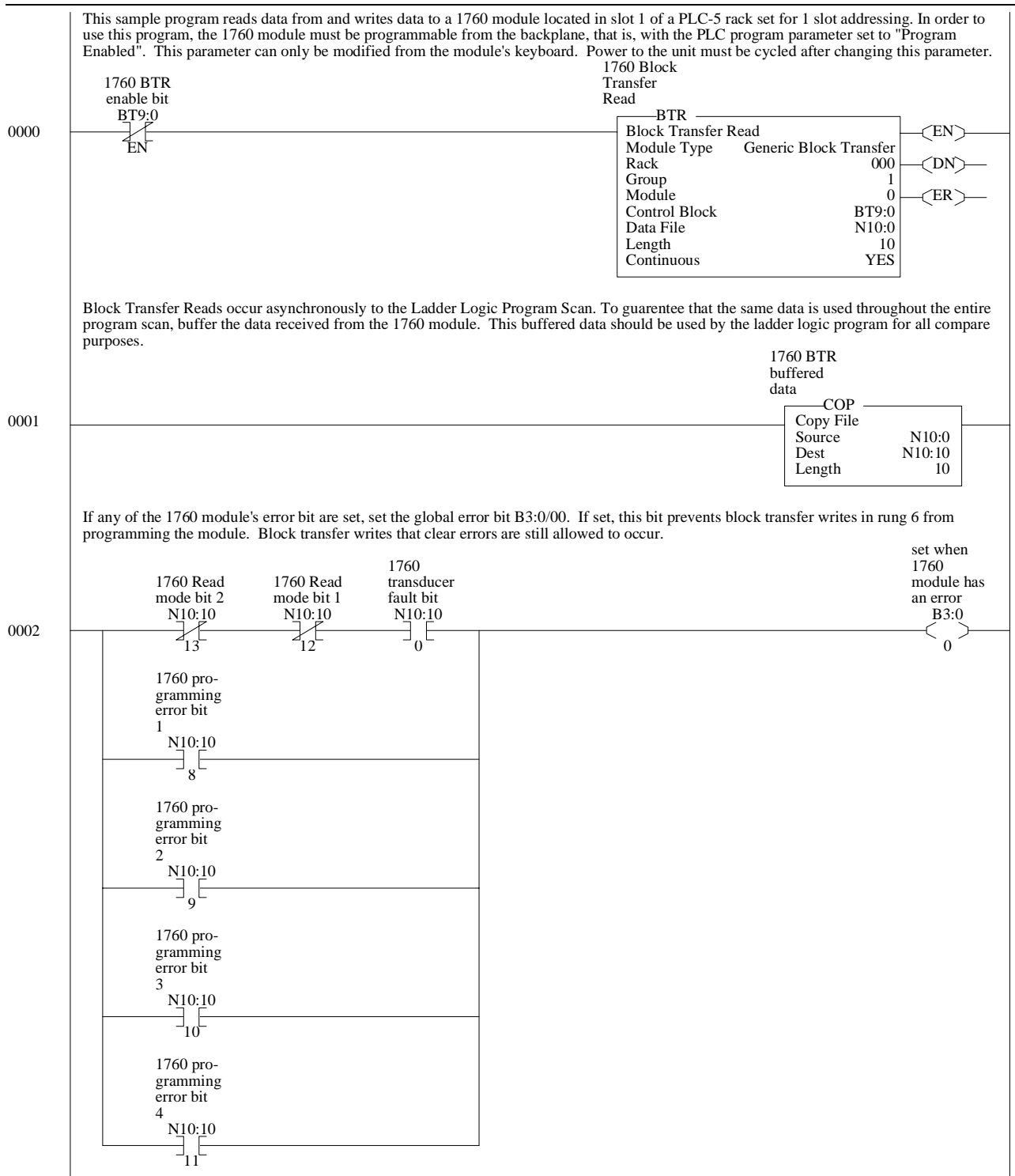

Ladder Logic (continued)

1760exam.rsp

LAD 2 - --- Total Rungs in File = 8

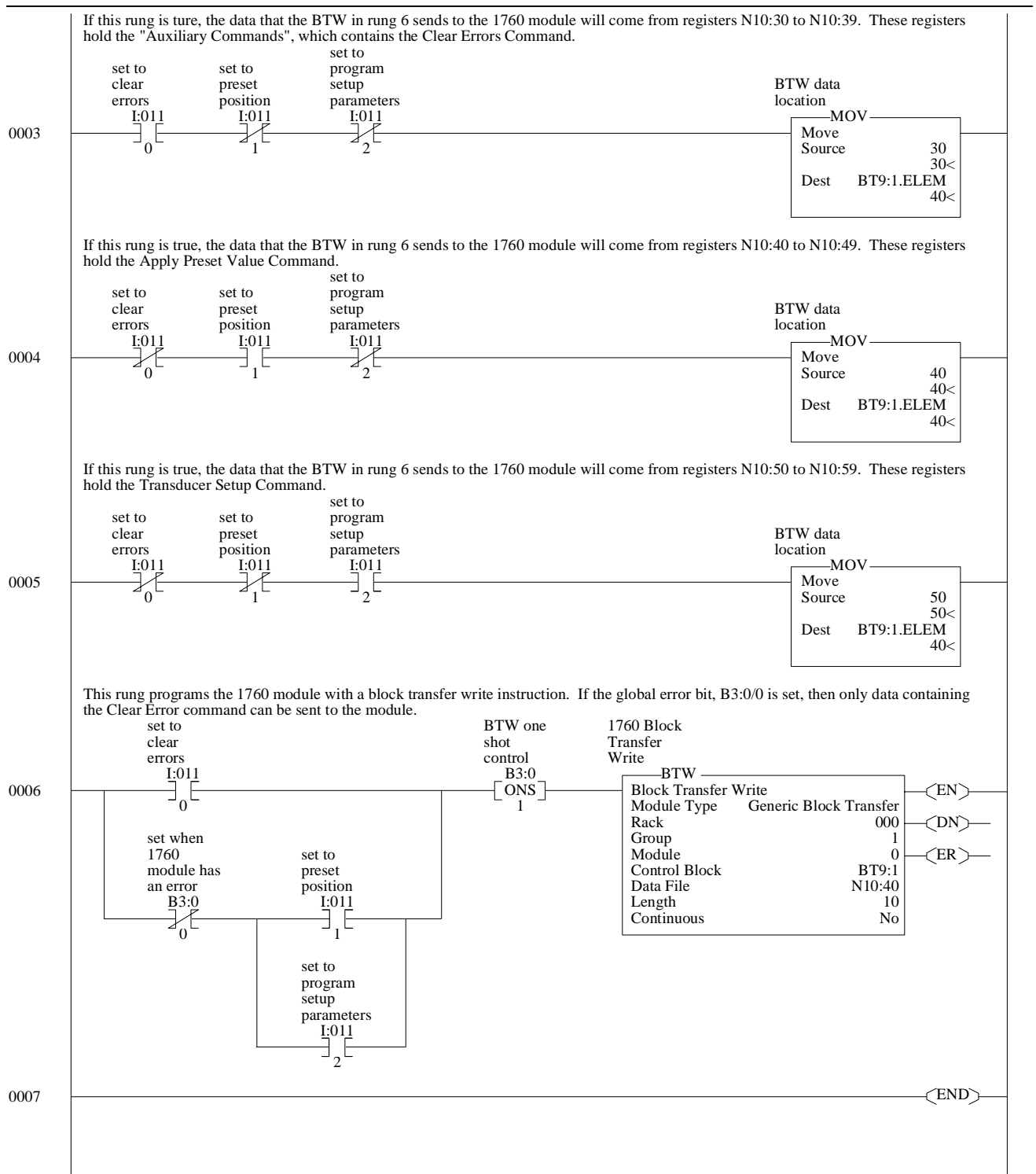



ADVANCED MICRO CONTROLS INC.

20 GEAR DRIVE, TERRYVILLE, CT 06786 T: (860) 585-1254 F: (860) 584-1973

www.amci.com

LEADERS IN ADVANCED CONTROL PRODUCTS