

Series 2700 Programmable Limit Switch Modules

User Manual



Allen-Bradley 1771 I/O Module

General Information

Important User Information

The products and application data described in this manual are useful in a wide variety of different applications. Therefore, the user and others responsible for applying these products described herein are responsible for determining the acceptability for each application. While efforts have been made to provide accurate information within this manual, AMCI assumes no responsibility for the application or the completeness of the information contained herein.

UNDER NO CIRCUMSTANCES WILL ADVANCED MICRO CONTROLS, INC. BE RESPONSIBLE OR LIABLE FOR ANY DAMAGES OR LOSSES, INCLUDING INDIRECT OR CONSEQUENTIAL DAMAGES OR LOSSES, ARISING FROM THE USE OF ANY INFORMATION CONTAINED WITHIN THIS MANUAL, OR THE USE OF ANY PRODUCTS OR SERVICES REFERENCED HEREIN.

Throughout this manual the following two notices are used to highlight important points.



WARNINGS tell you when people may be hurt or equipment may be damaged if the procedure is not followed properly.



CAUTIONS tell you when equipment may be damaged if the procedure is not followed properly.

No patent liability is assumed by AMCI, with respect to use of information, circuits, equipment, or software described in this manual.

The information contained within this manual is subject to change without notice.

Standard Warranty

ADVANCED MICRO CONTROLS, INC. warrants that all equipment manufactured by it will be free from defects, under normal use, in materials and workmanship for a period of [1] year. Within this warranty period, AMCI shall, at its option, repair or replace, free of charge, any equipment covered by this warranty which is returned, shipping charges prepaid, within one year from date of invoice, and which upon examination proves to be defective in material or workmanship and not caused by accident, misuse, neglect, alteration, improper installation or improper testing.

The provisions of the “STANDARD WARRANTY” are the sole obligations of AMCI and excludes all other warranties expressed or implied. In no event shall AMCI be liable for incidental or consequential damages or for delay in performance of this warranty.

Returns Policy

All equipment being returned to AMCI for repair or replacement, regardless of warranty status, must have a Return Merchandise Authorization number issued by AMCI. Call (860) 585-1254 with the model and serial numbers along with a description of the problem. An “RMA” number will be issued. Equipment must be shipped to AMCI with transportation charges prepaid. Title and risk of loss or damage remains with the customer until shipment is received by AMCI.

24 Hour Technical Support Number

24 Hour technical support is available on this product. For technical support, call (860) 583-7271. Your call will be answered by the factory during regular business hours, Monday through Friday, 8AM - 5PM EST. During non-business hours, an automated system will ask you to leave a detailed message and the telephone number where you can be reached. Please remember to include your area code. The system will page one of two engineers on call. Please have your product model number and a description of the problem ready before you call.

Table of Contents

General Information

Important User Information	Inside Front Cover
Standard Warranty	Inside Front Cover
Returns Policy	Inside Front Cover
24 Hour Technical Support Number	Inside Front Cover

About This Manual

Introduction	I
Revision Record	I
Past Revisions	I

Chapter 1 Series 2700 Introduction

Overview	1-1
2700 Module Functions	1-1
Typical 2700 Module Applications	1-2
Series 2700 Family Members	1-2
Compatible Transducers	1-3
Programmable Parameters	1-4
Transducer Setup Parameters	1-4
Scale Factor	1-4
Circular Offset	1-5
AutoZero Feature	1-5
Tachometer Response Time	1-6
Output Allocation	1-6
Limit Switch Parameters	1-7
ON/OFF Limit Setpoints	1-7
ON/OFF Advance Values	1-7
Backplane Programming	1-8
2700 Module Software Options	1-9
2731-04 Option	1-9
2732-04 Option	1-9
Module Specifications	1-10

Chapter 2 Module Description

Front Panel Description	2-1
Program Mode vs. Display Mode	2-2
Program Switch	2-2
Using the Function Display and Keyboard	2-3
Navigating in Display Mode	2-3
Navigating in Program Mode	2-3
Switching Between Channels	2-4
Indicator LED Patterns	2-4
Position Display	2-5
Tachometer Display	2-5
Transducer Setup Parameters	2-6
Tachometer Response	2-6
Scale Factor	2-6
Circular Offset	2-6
Output Allocation	2-7

Table of Contents

Chapter 2 Module Description (continued)

Limit Switch Parameters	2-7
Output Number	2-7
ON Limit Setpoints	2-7
OFF Limit Setpoints	2-8
Advance Output Number	2-8
ON Advance Value	2-8
OFF Advance Value	2-8
Error Messages	2-9
Transducer Fault (Error 1)	2-9
nvRAM Fault (Error 2)	2-9
RAM Error	2-10
Transducer Input connector	2-10
Limit Output connector	2-11
Fuse LEDs & Access Cover	2-12

Chapter 3 Installation

Power Requirements	3-1
Installing the Module	3-1
Keying Bands	3-2
Transducer Specifications	3-2
Transducer Mounting	3-2
Transducer Outline Drawings	3-3
Transducer Cable Installation	3-3
Transducer Cable Wiring Diagrams	3-3
C1T-(x) Wiring Diagram (2731 / 2741) with GC-1	3-3
C2T-(x) Wiring Diagram (2732 / 2742) with GC-1	3-4
GC-1 Grounding Clamp	3-4
Limit Switch Load Connections	3-5

Chapter 4 Module Keyboard Programming

Overview	4-1
Entering Limit Switch Parameters	4-1
Programming New ON/OFF Setpoints	4-2
Modifying Existing ON/OFF Setpoints	4-3
Clearing ON/OFF Setpoints	4-4
Programming ON/OFF Advance Values	4-5

Chapter 5 AMCI Module Addressing

Definition of Terms	5-1
Block Transfer	5-1
Single Transfer	5-1
I/O Rack	5-1
I/O Group	5-1
Slot Pair	5-1
2-Slot Addressing	5-2
1-Slot Addressing	5-2
½-Slot Addressing	5-2
Addressing the 2700	5-2
Addressing Shortcuts	5-2
Addressing Examples	5-3
2-Slot Addressing	5-3
1-Slot Addressing	5-3
½-Slot Addressing	5-4
Restrictions and Warnings	5-4

Chapter 6 PLC-5 BT Instructions

Overview	6-1
Module Address	6-1
Control Block	6-1
Data File	6-1
File Length	6-1
Block Transfer Reads	6-1
Block Transfer Writes	6-2
Continuous Parameter	6-2
Enable (EN), Error (ER), and Done (DN) Bits	6-2
PLC-5 Restrictions and Warnings	6-3

Chapter 7 Data Format

Block Transfer Data Format	7-1
Single Transfer Data Format (2731-04 only)	7-1

Chapter 8 Backplane Programming

Programming Structure	8-1
Program Instructions	8-2
Auxiliary Commands	8-2
Transducer Setup Instructions	8-3
Limit Switch Instruction	8-6
Programming Error Byte	8-7
Error Message Restrictions and Warnings	8-8

Chapter 9 Sample PLC-5 Program

Ladder Logic Program	9-1
Data File	9-25

Table of Contents

Appendix A 2742-18 Additional Instructions

Description of Option.....	A-1
New Parameters.....	A-2
Input Polarity and Output Trigger	A-2
Cycle Length.....	A-3
Limit Switch Programming	A-3
Limit Switch Output Diagrams	A-4
Edge Triggered	A-4
Level Triggered	A-5
BTR Data Format	A-6
Status Bits	A-6
Notes.....	A-6
Backplane Programming	A-7
Backplane Programming Error Codes.....	A-9
Input Hardware Connections.....	A-9
Equivalent Circuit.....	A-9
Input Voltage Specifications.....	A-9
Hookup to DC Source Output Sensors	A-10
Hookup to DC Sink Output Sensors.....	A-10
Using the 2742-18 with a Single Transducer	A-11
Transducer Connections	A-11
Material Sensor Connections.....	A-11

Introduction

This manual explains the operation, installation, programming , and servicing of four Series 2700 Intelligent Programmable Limit Switch (PLS) Modules manufactured by Advanced Micro Controls Inc. (AMCI). These modules include the 2731, 2732, 2741, and 2742.

It is strongly recommended that you read the following instructions. If there are any unanswered questions after reading this manual, call the factory. An applications engineer will be available to assist you.

AMCI is a registered trademark of Advanced Micro Controls Inc.

The AMCI logo is a trademark of Advanced Micro Controls Inc.

PLC-2, PLC-3, and PLC-5 are registered trademarks of Allen-Bradley Company.

Viton is a registered trademark of E.I. DuPont.

This product is licensed under patents and proprietary technology of Allen-Bradley Company, Inc. Allen-Bradley Company, Inc. does not warrant or support this product in any manner..

Manuals at AMCI are constantly evolving entities. Your questions and comments on this manual and the information it contains are both welcomed and necessary if this manual is to be improved. Please direct all comments to: Technical Documentation, AMCI, 20 Gear Drive, Plymouth Industrial Park, Terryville CT 06786, or fax us at (860) 584-1973. You can also e-mail your comments and suggestions to *techsupport@amci.com*.

Revision Record

The following is the revision history for this manual. In addition to the information listed here, revisions will fix any known typographical errors and clarification may be added.

This manual, 940-07090, supercedes manual 2700-295M. It completely changes to format of the manual and should be easier to use. Information on the 2731-04, 2732-04, and 2742-18 modules has also been incorporated into this manual.

Past Revisions

2700-293M: Original cataloged manual.

2700-295M: Added a Revision History page.

About This Manual

Notes

This chapter serves as an introduction to the Series 2700 modules. It highlights the Series 2700 family members, potential applications, compatible transducers, and key features for all the modules.

Overview

The Series 2700 modules are Allen-Bradley 1771 I/O compliant cards that convert resolver signals to digital position and tachometer data that can be reported over the backplane using block transfers. An option is available that allows the 2731 module to communicate the transducer position value using single transfers. The 2700 modules eliminate the separate resolver decoder box, PLC input card, and associated wiring needed to bring the digital data into a PLC.

All the Series 2700 modules are two slot cards with up to two resolver inputs and eight high-current outputs. Each module has an integral keyboard and display that allow you to setup the module, and monitor resolver position and tachometer data.

Each 2700 module connects to one or two brushless, resolver-based transducers for position feedback, and generates eight outputs based on a specific transducer's position, programmed setpoints, and speed compensation advances. The position resolution of each transducer is limited only by the electronics that decode its signals. When attached to a 2700 module, the resolver transducer will provide an absolute position value with up to twelve bit resolution over a six conductor cable. An absolute optical encoder requires a cable with at least fourteen conductors to provide the same resolution.



2700 Module Functions

Each 2700 module provides the following key functions:

- Monitors the position and velocity of resolver-based transducer(s).
- Controls the state (ON/OFF) of eight outputs as a function of transducer position data, user programmed limits (ON/OFF points) and speed compensation advances.
- Provides eight multiple limits (ON/OFF points) on each output with a throughput of 200 uSec.
- Automatically advances the programmed limits (ON/OFF points) independently with values proportional to the velocity of the transducer's shaft and user-programmed delays.
- Allows the user to monitor the transducer position or velocity, and change the values of the module's programmable parameters using the integral keyboard and display.
- Communicates with the programmable logic controller (PLC) using block transfers.
- Provides the PLC with the position and velocity of the transducer, the state of the limit outputs, and extensive fault diagnostics.
- Full compatibility with the 1771 I/O chassis is guaranteed by proprietary bus interface technology and a custom VLSI integrated circuit licensed from Allen-Bradley.

Figure 1.1 2700 Module

Chapter 1 Series 2700 Introduction

Typical 2700 Module Applications

A 2700 module application generally falls into one of two general categories:

- **Rotary Application** – The resolver position directly correlates to an angular position on the machine. One example is monitoring a press ram. As the press cycles through one turn, the resolver position is used to monitor and control such functions as material feed and part blow-off.
- **Linear Application** – The resolver position correlates to a physical length. These applications can be either single turn or multi-turn. An example of a single turn application is a packaging machine where the resolver completes one turn for each product. Here the resolver position is used to control when glue is applied or when the package is cut to length. An example of a multi-turn application is monitoring the position of a load on either a track or ball screw. In this type of application, linear position is translated to rotary position through either a wheel or gearing. The transducer completes several rotations in order to travel the complete distance.

Series 2700 Family Members

The four modules in the 2700 series are listed below. Complete operation, installation, programming, and servicing instructions for each module are provided in this manual.

Model	Transducer Inputs	Resolution
2731	1	10 bit (1,024 counts)
2731-04	1	10 bit (1,024 counts)
2732	2	10 bit (1,024 counts)
2732-04	2	10 bit (1,024 counts)
2741	1	12 bit (4,096 counts)
2742	2	12 bit (4,096 counts)
2742-18	2	12 bit (4,096 counts) Packaging PLS

Table 1.1 Series 2700 Family Members

The 2730 and 2740 modules covered by this manual are primarily intended for single turn applications. They can be used in multi-turn applications by placing a gear ratio between the output shaft of the machine and the transducer. AMCI has a line of transducers with an internal (x):1 ratio for use in these applications. However, you must remember that the maximum number of counts remains fixed at either 1,024 or 4,096 counts.

Refer to Table 1.2, AMCI Compatible Transducers, for more information on the single and multi-turn transducers available from AMCI for use with the 2730 and 2740 modules.

Compatible Transducers

The resolver-based transducers compatible with the 2700 modules are listed in the following table. Note that Advanced Micro Controls Inc. (AMCI) manufactures each of these transducers.

Model	Shaft	Mount	Turns	Comments
R11X-J10/7	0.120"	Servo	1	NEMA 1, Size 11, Resolver
HT-6	0.188"	Front or Side	1	NEMA 13 RES-1 transducer
HT-20	0.625"	Front or Side	1	NEMA 13 heavy duty transducer
HT-20S	0.625"	Front or Side	1	HT-20 with side connector
HT-20K	0.625"	Front or Side	1	NEMA 4X HT-20 with Viton shaft seal
HT-20L	0.625"	Front or Side	1	NEMA 4X HT-20 with Nitril shaft seal
HT-20C	0.625"	Front or Side	1	NEMA 4X stainless steel HT-20, Viton Seal, conduit conductor
H25-FE	0.375"	Flange	1	NEMA 4, size 25, end connector
H25-FS	0.375"	Flange	1	NEMA 4, size 25, side connector
H25-FL	0.375"	Flange	1	NEMA 4, size 25, integral 15 foot (3m) cable
H25-SE	0.375"	Servo	1	NEMA 4, size 25, end connector
H25-SS	0.375"	Servo	1	NEMA 4, size 25, side connector
H25-SL	0.375"	Servo	1	NEMA 4, size 25, integral 15 foot (3m) cable
HT-20-(x)	0.625"	Front	(x)†	HT-20 with internal (x):1 gear ratio
HTT-20-1	0.625"	Front	1	Redundant single turn resolvers‡

Table 1.2 Compatible Transducers

† Available gear ratios are: 2:1, 2.5:1, 2.77:1, 3:1, 4:1, 4.8:1, 5:1, 6:1, 7:1, 8:1, 9:1, 10:1, 12:1, 13:1, 15:1, 16:1, 20:1, 24:1, 36:1, 40:1, 50:1, 60:1, 64:1, 100:1, 105:1, 150:1, 180:1, 250:1, and 256:1.

‡ This package contains two resolvers geared 1:1 with the input shaft. Most commonly used in systems that mandate redundant sensors. AMCI can install two different size 11 resolvers in the package per customer requirements. Contact AMCI for more information.

Chapter 1 Series 2700 Introduction

Programmable Parameters

You may configure a 2700 module by setting its programmable parameters, which may be broken down into two groups:

- **Transducer Setup Parameters** – Four parameters that affect the position and tachometer data, and the outputs assigned to each transducer. Multi-channel modules repeat these parameters for each transducer. For example, if you have a two-channel module, you may enter two Scale Factor parameters, one for each transducer. These parameters are programmable from either the keyboard or the processor.
- **Limit Switch Parameters** – Include Output Number and Output Advance Number selection parameters, Limit Switch ON/OFF setpoints, and ON/OFF Advance parameters. There is only one of each of these parameters. They are not repeated for each transducer on multi-channel modules. These parameters are also programmable from either the keyboard or the processor.

Programmable parameters are stored in each module's nonvolatile memory. Therefore, you do not have to configure a module after every power up. The nonvolatile memory is battery backed, non-volatile, static RAM (or nvRAM). The battery in the nvRAM is rated for ten years, and the nvRAM has an unlimited number of write cycles.

Transducer Setup Parameters

The following terms are related to Transducer Setup Parameters:

Absolute Resolver Position – Represents the actual angular displacement of the transducer shaft from its mechanical zero reference.

Machine Position – The transducer position reported by a 2700 module, which equals the sum of the absolute resolver position and the Circular Offset parameter described below.

Scale Factor

The Scale Factor sets the number of counts per turn of the transducer.

- The Scale Factor default value is 360. This gives 1-degree resolution.
- 2730 modules can program the Scale Factor to any value between 2 and 1024.
- 2740 modules can program the Scale Factor to any value between 2 and 4096.

Note that when the Scale Factor is set to its default value of 360, the Position value is defined in angular degrees. The Scale Factor also controls the resolution of the ON and OFF points of the Limit Outputs. When the Scale Factor is set to 360, the Limit Outputs can turn ON and OFF every one angular degree. Programming the Scale Factor resets the Circular Offset to zero.

Transducer Setup Parameters (continued)

Circular Offset

The Circular Offset parameter allows you to adjust the module's position without rotating the shaft. Use the following formulas to calculate the Circular Offset if the offset presently equals zero.

If Desired Position > Current Position:

$$\text{Circular Offset} = \text{Desired Position} - \text{Current Position}$$

Example 1: Scale Factor = 4.096
Current Position = 1234
Desired Position = 2000
Zero Offset = 2000 - 1234 = 766

If Desired Position < Current Position:

$$\text{Circular Offset} = \text{Scale Factor} - (\text{Current Position} - \text{Desired Position})$$

Example 2: Scale Factor = 1,024
Current Position = 987
Desired Position = 123
Circular Offset = 1024 - (987 - 123) = 1024 - (864) = 160

If the Circular Offset is not zero when calculating a new offset, then it must be taken into account. Calculate your new Circular Offset as shown in the examples above and then add the current Circular Offset value to your answer. If this new offset is greater than or equal to the value of the Scale Factor, then subtract the Scale Factor from the new offset.

To continue Example 2 above:

Counts/Turn = 1,024
Calculated Circular Offset = 160
Present Circular Offset = 983
Circular Offset = 160 + 983 = 1,142
(Note that this offset value exceeds the Scale Factor of 1,024.)
New Circular Offset = 1142 - 1024 = 119

AutoZero Feature

The 2700 has an AutoZero feature that automatically calculates the Circular Offset needed to bring the position value to zero. When the module is in Program Mode, which is described on page 2-2, press the **[CLEAR]** key while displaying the position value. The module will automatically calculate and store the Circular Offset needed to make the position value zero.

Transducer Setup Parameters (continued)

Tachometer Response Time

The tachometer reports the angular velocity of the transducer shaft in revolutions per minute (RPM). This parameter sets the time between tachometer updates and the tachometer resolution. Update times are 30, 60, 120, and 240 milliseconds. The two resolutions, available only with the 240 milliseconds update time, are 1.0 or 0.1 RPM.

- The tachometer response default value is 240 milliseconds with 1.0 RPM resolution.
- This parameter *only* affects the update time of the tachometer. It does not affect the update time of the position value or limit switch outputs, which is always 200 microseconds for single channel units and 400 microseconds for two channel units.

Update time affects the maximum speed the module can report without error. If the speeds listed in the following table are exceeded, the module will display erroneous data as well as send it to the processor.

Update Time	Resolution	Max. Speed
30 milliseconds	1.0 RPM	5000 RPM
60 milliseconds	1.0 RPM	5000 RPM
120 milliseconds	1.0 RPM	5000 RPM
240 milliseconds	1.0 RPM	5000 RPM
240 milliseconds	0.1 RPM	999.9 RPM

Table 1.3 Maximum Tachometer Values

Output Allocation

If you have a multi-channel module (i.e., a 2732 or 2742 module), use this parameter to specify which of the eight available outputs will be allocated to the first transducer. The following table shows some output allocation examples.

Display Values	Resolver 1 Controlled Outputs	Resolver 2 Controlled Outputs
rES 1-8	1 to 8	None
rES 1-6	1 to 6	7 and 8
rES 1-0	None	1 to 8

Table 1.4 Sample Output Allocation Values

NOTE: It is not possible to individually select which transducer will control a specific output.

Limit Switch Parameters

ON/OFF Limit Setpoints

Up to eight pairs of ON/OFF limit setpoints may be entered for each output. Each ON setpoint for a specific output represents the Machine Position (i.e., the transducer position reported by the 2700 module) where you want the output to turn ON. The corresponding OFF setpoint represents the Machine Position where you want the output to turn OFF. ON and OFF setpoints are always programmed in pairs. An output is ON when the Machine Position is greater than or equal to the ON setpoint and less than the OFF setpoint specified in a pair.

For example, an ON setpoint of 230 and an OFF setpoint of 270 will turn the selected output ON each time the Machine Position reaches 230 and OFF when the Machine Position reaches 270. Note that to compensate for fixed delays in an application, an ON advance value may be entered to force the output to turn ON a specified number of milliseconds before the Machine Position reaches the ON setpoint. An OFF advance value may be entered to turn the output OFF before the Machine Position reaches the OFF setpoint.

ON/OFF Advance Values

ON/OFF advances are used to compensate for fixed delays associated with the mechanical actuation of the load attached to the limit switch output. When you program an ON advance for an output, the output will turn ON before the programmed ON setpoint by the number of milliseconds specified by the ON advance. The OFF advance affects the OFF setpoints in a similar fashion. On the 2731 and 2741, the first five outputs have associated ON/OFF advances. The 2732 and 2742 have ON/OFF advances on all eight outputs. Note that the programmed OFF advance must be less than or equal to the ON advance.

Consider an example where a limit output controls a solenoid (i.e., the “load”), and the solenoid pulls mechanically 10 milliseconds after voltage is applied to its terminals and releases 5 milliseconds after voltage is removed. The solenoid functions as part of a control system for a machine with variable speed. In this case, enter an ON advance value of 10 milliseconds and an OFF advance value of 5 milliseconds to make the ON and OFF setpoints independent of the machine speed.

Chapter 1 Series 2700 Introduction

Backplane Programming

The 2700 module can be programmed over the backplane with block transfer writes. The programming format is a series of *Program Instructions* shown below. Block transfers can transmit a maximum of sixty-four words. However, this does not limit how many parameters you can program at one time.

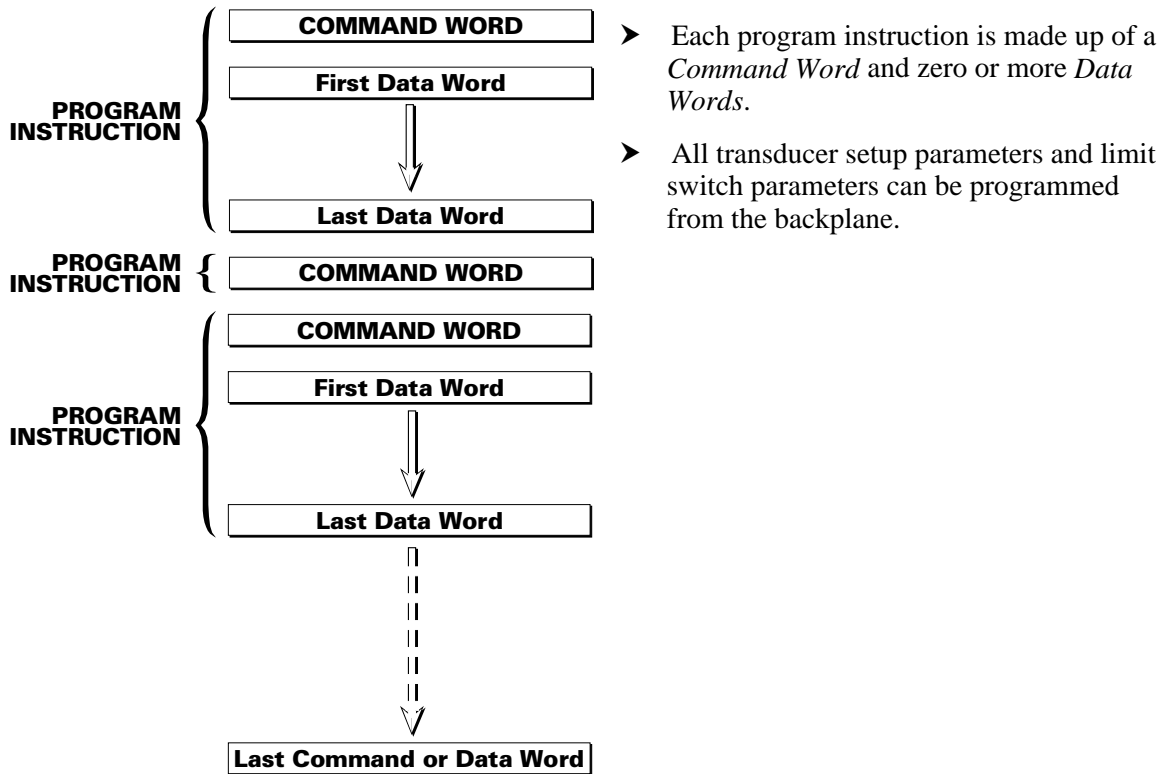

Figure 1.2 2700 Programming Structure

2700 Module Software Options

A number of additional programming features are provided by the following software options. Each option is available for the specific 2700 modules listed below.

2731-04 Option

The -04 option for the 2731 module performs all of the functions provided by a standard 2700 module, and also removes the restrictions for programming ON and OFF advance values. An OFF advance value (expressed in milliseconds) may be less than, equal to, or *greater than* the ON advance value specified for the same output.

In addition to the above functionality, the 2731-04 has the added feature of placing the resolver position data in the input image table, while still allowing simultaneous Block Transfer operations to occur. However, because of this, the 2731-04 module must be used in a PLC-5 system using 1-slot or ½-slot addressing. Refer to Chapter 5 for additional information and examples on how to address a 2731-04 in a PLC-5 system.

2732-04 Option

The -04 option for the 2732 module performs all of the functions provided by a standard 2700 module, and (similar to the -04 option described above) removes the restrictions for programming ON and OFF advance values. An OFF advance value (expressed in milliseconds) may be less than, equal to, or *greater than* the ON advance value specified for the same output. Unlike the 2731-04, the 2732-04 does not support single transfers.

2742-18 Option

The -18 option is an extensive software and hardware modification that allows the 2742 to function as a two channel glue gun controller in packaging applications. Each transducer channel has an associated input. The outputs do not fire until the input activates and then they can be programmed to fire only once, or as long as the input is active.

Chapter 1 Series 2700 Introduction

Module Specifications

Module Location

Any 1771 I/O Chassis, occupies 2 slots

Position Transducer

AMCI Brushless Resolver

Transducer Input

Transformer Isolated

Position Resolution

All modules internal to 1 part in 8192
273x Modules programmable to 1 part in 1024
274x Module programmable to 1 part in 4096

New Position Throughput Time

200 uSec: 2731, 2731-04, 2741 Modules
400 uSec: 2732, 2732-04, 2742, 2742-18 Modules

Programmable Parameters

Scale Factor
Circular Offset
Tachometer Response Time
Tachometer Resolution
Limit Setpoints
Limit Setpoint Advances
Limit Output Mask (Processor Instruction only)

Position Offset

Programmable to Full Scale Count

Programmable Tachometer Response Times

32, 60, 120, or 240 milliseconds (27x1)
30, 60, 120, or 240 milliseconds (27x2)

Tachometer Resolution

1 RPM at 30, 32, 60 or 120 milliseconds response time
Programmable 1 or 0.1 RPM at 240 milliseconds response time

Tachometer Range

1 to 2000 RPM at 30, 32, 60 or 120 milliseconds response time
1 to 1000 or 0.1 to 999.9 RPM at 240 milliseconds response time

Program Input

Module's keyboard or Block Transfer Write
From programmable controller

Program Storage

nvRAM Memory

Number of Outputs

8

Number of Limit ON/OFF Setpoints

8 Pairs of ON/OFF Setpoints per Output

Setpoint Advances

Independent ON and OFF Setpoint Advances programmable from 0 to 99 milliseconds
Separate Advances for each Limit Output
Available on Limits 1 – 5: 2731, 2741
Available on Limits 1 – 8: 2732, 2742

Output Current Rating

2A DC Sourcing per Output
5A DC Limit per group of 4 outputs

Surge Rating

4A for 10milliseconds

Output Power Supply

External +12V DC to +40V DC

Output Fuses (1 per Group of 4 Outputs)

7A Fast Blow (Littelfuse 225007)

Output Isolation

1500 Vrms Minimum (opto isolated)

DC Supply from Backplane

+ 5 Volts @ 0.75A max. (2 axis module)

Connector Keying

Between 28 and 30
Between 34 and 36

Environmental Conditions

Operating Temperature: 0 to 60° C.
Relative Humidity: 5 to 95%
(without condensation)
Storage Temperature: -40 to 85° C.

This chapter describes the physical layout of a Series 2700 module as well as keyboard programming.

Front Panel Description

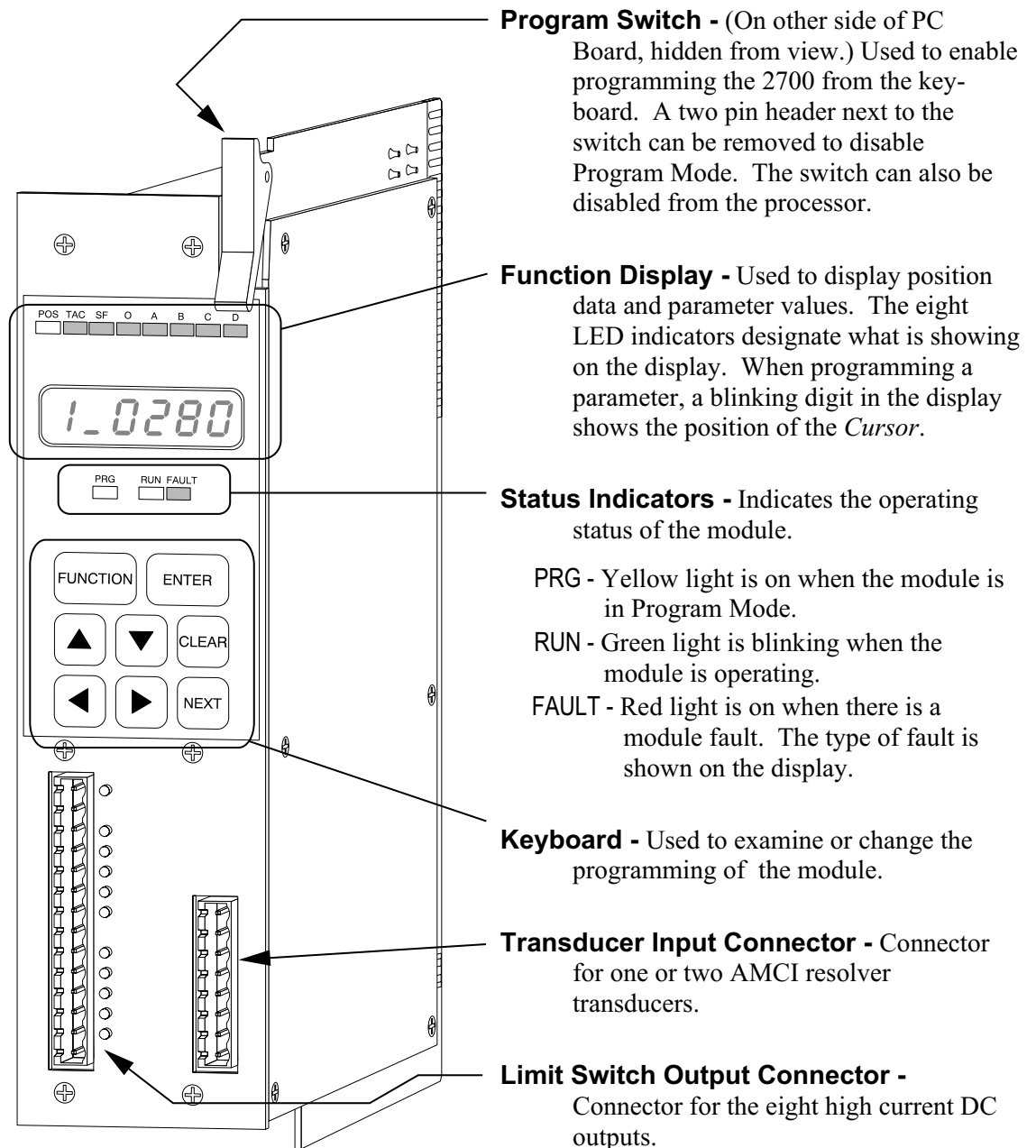

Figure 2.1 2700 Front Panel

Chapter 2 Module Description

Program Mode vs. Display Mode

The front panel has two operating modes:

- **Program Mode** – (Yellow PRG light on) The parameters can be modified from the keyboard. The position can be reset by pressing the [CLEAR] key while displaying the position value.
- **Display Mode** – (Yellow PRG light off) The parameters can be inspected, but not modified. You cannot reset the position from the keyboard.

Program Mode and Display Mode refer to the module's front panel only. The module can be locked into display mode by removing a jumper located near the Program Switch as described in the following section. It is usually good practice to lock the module into display mode once the system is operational. This will prevent someone from accidentally changing the parameters while the system is running. The only times that programming changes should be allowed are during set-up or troubleshooting procedures.

Program Switch

The Program Switch is used to quickly enable or disable program mode as long as the 2700 module has not been locked into display mode from the processor. The module is in program mode when the switch is pushed towards the back of the module. The module is in display mode when the switch is pushed toward the front of the module. The yellow PRG light is on when the module is in program mode.

The Program Switch can be disabled by removing the jumper on the two pin header next to the switch. The location of the jumper is shown in Figure 2.2. Removing this jumper locks the 2700 module in display mode.



WARNING

Remove system power before removing or installing any module in an I/O chassis.

Failure to observe this warning can result in damage to the module's circuitry and/or undesired operation with possible injury to personnel.

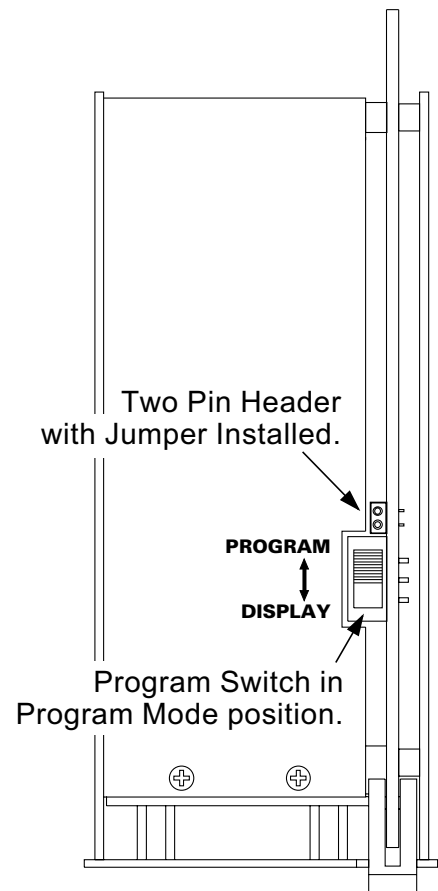

Figure 2.2 Program Switch

Using the Function Display and Keyboard

You can examine position and tachometer values as well as inspect or program all of the programmable parameters using the display and keyboard. The [FUNCTION] key, along with the [▶] and [◀] keys, are used to cycle between displays. Figure 2.3 shows the display order.

Navigating in Display Mode

When compared to program mode, the display mode is easier to navigate. If you are unfamiliar with the module, learn how to navigate between displays while in display mode. Navigating in program mode will then be easier to learn.

The [FUNCTION] and [▶] keys cycle you through the displays in one direction (down in Figure 2.3). The [◀] key cycles you through the displays in the opposite direction. Note that the display order is circular. Pressing the [FUNCTION] key while displaying the OFF Advance parameter will return you to the position display. Pressing the [▶] key will then return you to the OFF Advance parameter.

Navigating in Program Mode

The [FUNCTION] key is still used to cycle through the displays.

When you switch to a parameter display, the first digit of the value will be blinking. This shows the position of the *Cursor*. Use the [▶] and [◀] keys to move the cursor and [▲] and [▼] to change the value of the digit under the cursor. To quickly set most parameters to zero, press the [CLEAR] key. Once the parameter value is correct, press the [ENTER] key to accept it. The cursor is removed from the display if the new value is valid.

The module will only accept valid values for the parameters. If the module does not accept a value, it will return the display to the last valid number and move the cursor to the first digit. The valid range for many parameters is based on the values of other parameters. If the module does not accept a new value, check the other parameter settings.

Pressing the [FUNCTION] key at any time will remove the cursor and the module will display the last valid setting for the parameter. You can then use the [FUNCTION], [▶], or [◀] key to move to the next or previous display.

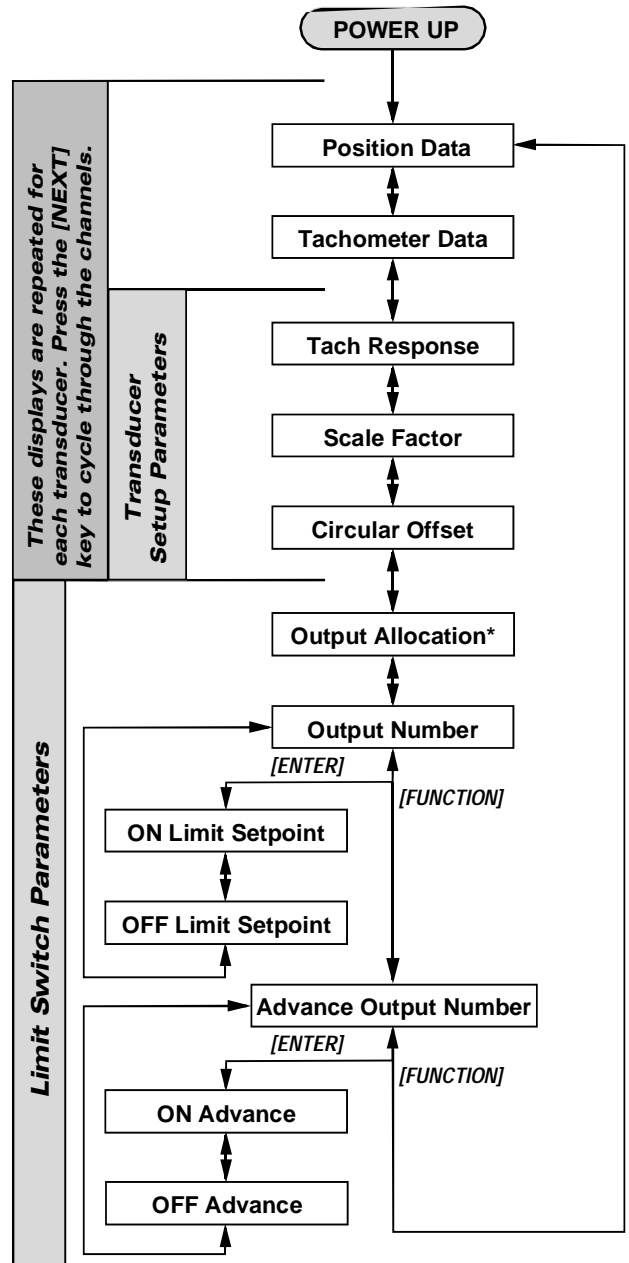

* Output Allocation is available on the 2732, 2732-04, and 2742 only.

Figure 2.3 Module Display Order

Chapter 2 Module Description

Using the Function Display and Keyboard (continued)

Switching Between Channels

Pressing the [NEXT] key will cycle through the transducer channels when displaying the position value, tachometer value, or transducer setup parameters. You will remain in the same display, only switching channels. The first digit of these displays usually tells you which channel is being displayed. For example, if you have a 2732 module and are displaying the Scale Factor parameter, press [NEXT] twice to cycle through the two Scale Factor values.

Indicator LED Patterns

The eight LEDs above the seven segment displays are the indicator LEDs. Figure 2.4 is a list of the displays and their indicator LED patterns. Note that some of the parameters have the same indicator pattern. In these cases, the actual displays are different enough to distinguish between the parameters.

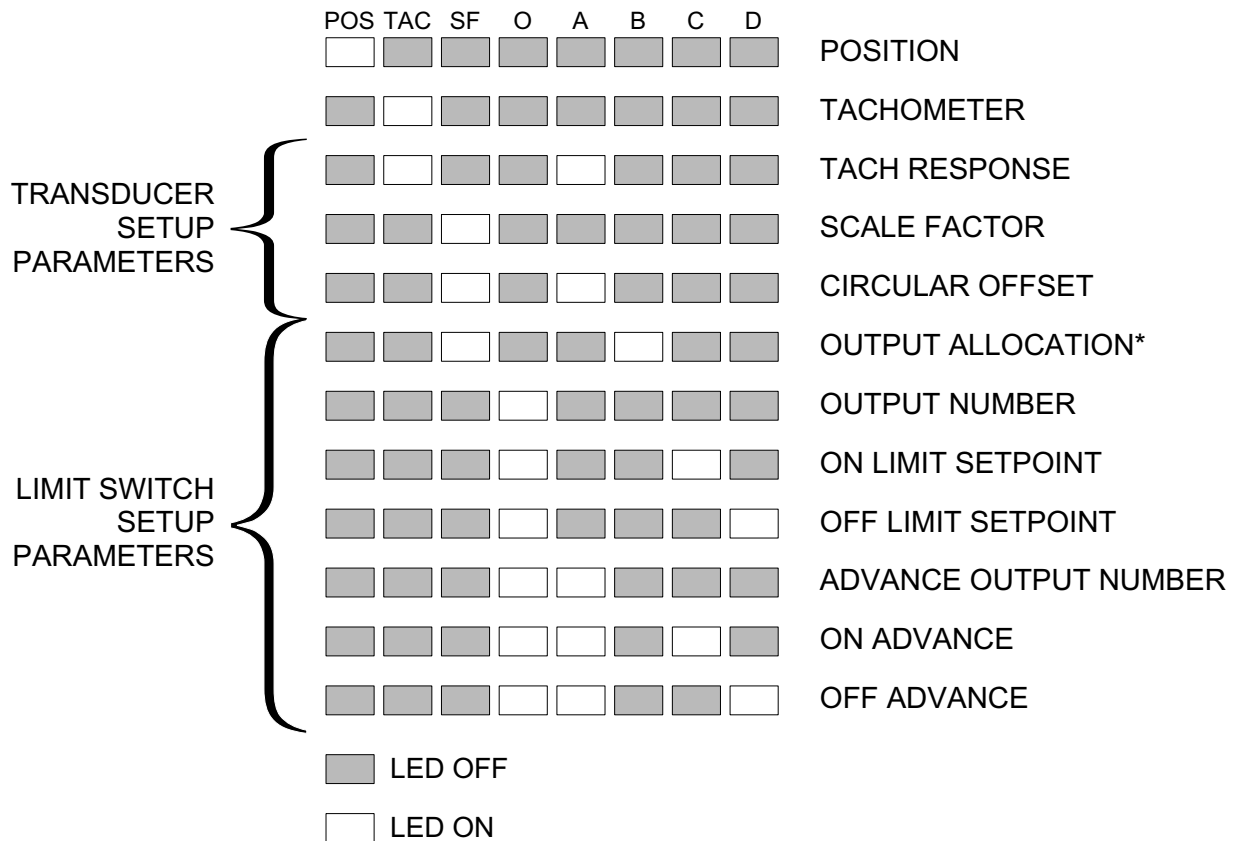

* 2732, 2732-04 and 2742 modules only.

Figure 2.4 Indicator LED Patterns

Position Display

As shown in Figure 2.5A, the position display shows the current position when a transducer is properly attached to the channel. The first digit is the transducer channel. If you have a multi-channel module (i.e., either the 2732 or 2742 module), press the [NEXT] key to cycle through the additional position displays.

If there is a transducer fault on the input channel, the position display will change to the one shown in Figure 2.5B. The red FAULT LED is lit when there is a transducer fault. If this LED is on while the position is displayed, the fault is on one of the other channels. Use the [NEXT] key to switch to the faulted channel. The fault can be cleared by pressing the [CLEAR] key if the 'Err1' message is blinking.

Refer to the *Error Messages* section, starting on page 2-9, for more information on the causes of a transducer fault.

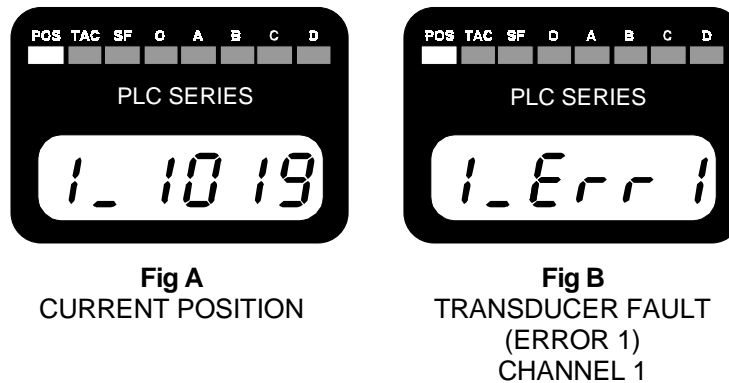

Figure 2.5 Position and Transducer Fault Displays

Tachometer Display

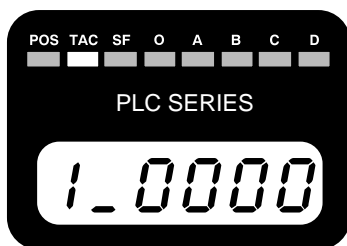

Figure 2.6 Tachometer Display

The tachometer display shows the current speed of the transducer in revolutions per minute with either 1.0 or 0.1 RPM resolution.

If there is a transducer fault, the display will show the 'Err1' message instead of the current speed. (See the *Position Display* section above.) The red FAULT LED is lit when there is a transducer fault. If this LED is on while the tachometer is displayed, the fault is on one of the other

channels. Use the [NEXT] key to switch to the faulted channel. The fault can be cleared by pressing the [CLEAR] key if the 'Err1' message is blinking.

Chapter 2 Module Description

Transducer Setup Parameters

The following are the front panel displays of the transducer setup parameters along with default values, range of values, and any special programming instructions. The first digit of these displays usually tells you which channel is being displayed. If you have a multi-channel module, use the [NEXT] key to switch between channels.

Note: The page number listed in each heading identifies the page in Chapter One that more fully describes the function of the parameter.

Tachometer Response Pg. 1-6



Figure 2.7 Tach Response

Default: 240 milliseconds update, 1.0 RPM resolution

Range: 30 milliseconds update, 1.0 RPM resolution
60 milliseconds update, 1.0 RPM resolution
120 milliseconds update, 1.0 RPM resolution
240 milliseconds update, 1.0 RPM resolution
240 milliseconds update, 0.1 RPM resolution

Special: The [▲] and [▼] keys change the entire value, not one digit. The [◀] and [▶] keys have no effect. The display shows '0240' for 1 RPM resolution, '240.0' for 0.1 RPM resolution.

Scale Factor Pg. 1-4



Figure 2.8 Scale Factor

Default: 360 Counts (1° resolution)

Range: 2 to 1024 counts inclusive (2731, 2732)
2 to 4096 counts inclusive (2741, 2742)



Programming this parameter will reset the Circular Offset parameter to its default setting of zero.

Circular Offset Pg. 1-5



Figure 2.9 Circular Offset

Default: 0

Range: 0 to (Scale Factor - 1)



Programming the Scale Factor parameter resets the Preset Value to zero.

Transducer Setup Parameters (continued)

Output Allocation Pg. 1-6

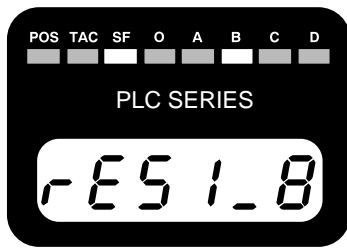

Figure 2.10 Output Allocation

Default: 8

Range: 0 to 8 (total number of outputs)



This parameter is only available if you have the 2732 or 2742 (multi-channel) module. The Output Allocation Parameter assigns the number of outputs controlled by resolver 1. For example, if you enter 6 (instead of the 8 shown here), outputs 1 to 6 will be controlled by resolver 1 and resolver 2 will control outputs 7 and 8.

Limit Switch Parameters

The following are the front panel displays of the limit switch parameters along with default values and the range of values. The first or second digit of these displays usually tells you which channel is being displayed.

Note: The page number listed in each heading identifies the page in Chapter One that more fully describes the function of the parameter.

Output Number

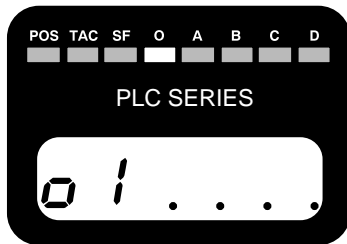

Figure 2.11 Output Number

Default: 1

Range: 0 to 8 (total number of outputs)

The Output Number display does not change any parameters. It is simply a display that allows you to quickly select the proper limit switch for programming.

ON Limit Setpoints Pg. 1-7



Figure 2.12 ON Limit Setpoints

Default: 0

Range: 0 to (Scale Factor -1)

Chapter 2 Module Description

Limit Switch Parameters (continued)

OFF Limit Setpoints Pg. 1-7



Default: 0

Range: 0 to (Scale Factor -1)

Figure 2.13 OFF
Limit Setpoints

Advance Output Number

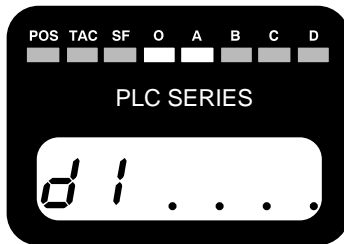

Default: 1

Range: 0 to 5 for 2731, 2731-04, and 2741
0 to 8 for 2732, 2732-04, and 2742

The Advance Output Number display does not change any parameters. It is simply a display that allows you to quickly select the proper limit switch advance for programming.

Figure 2.14 Advance
Output Number

ON Advance Value Pg. 1-7

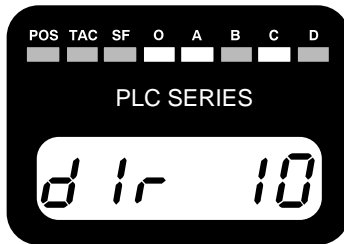

Default: 0

Range: 0 to 99 milliseconds

Figure 2.15 ON
Advance Value

OFF Advance Value Pg. 1-7

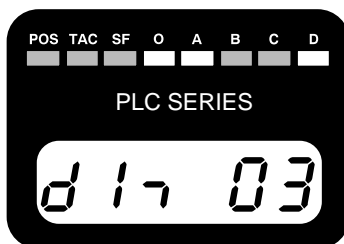

Default: 0

Range: 2731, 2732, 2741, 2742: Less than or equal to the ON advance for the output.

2731-04, 2732-04: 0 to 99 milliseconds

Figure 2.16 OFF
Advance Value

Error Messages

There are three types of faults that a 2700 module will recognize:

- **Transducer Fault (Error 1)** – A problem exists on a transducer channel.
- **nvRAM Fault (Error 2)** – A problem exists with the non-volatile RAM, or parameter values are not stored correctly.
- **RAM Error** - Unrecoverable error in the RAM memory used to store limit switch status information.

In all cases, the red FAULT LED will be on and the module will display an error message as shown below. These errors are also reported over the backplane. See Chapter 7 for detailed information describing how errors are reported over the backplane.

Transducer Fault (Error 1)

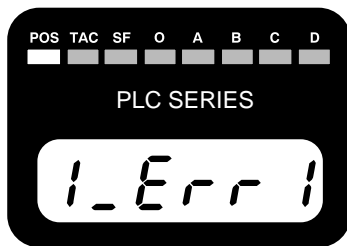

Figure 2.17
Transducer Fault

This message only appears when the module is displaying position or tachometer data. The parameters are displayed normally. If the FAULT LED is on while the position is displayed, the fault is on the other channel (on a multi-channel 2732 or 2742 module). Use the [NEXT] key to switch to the faulted channel. If the 'Err1' message is blinking, press the [CLEAR] key to clear the fault. There are six major causes of a transducer fault:

- Broken or intermittent transducer cable
- Non-compatible transducer
- Improper wiring of the transducer cable
- Improper installation of the transducer cable
- Faulty transducer
- Faulty module

nvRAM Fault (Error 2)

All of the parameters are stored in non-volatile static RAM memory when power is removed from the module. The nvRAM has an integral lithium battery that will maintain the parameter values in the absence of power for approximately ten years from the date of manufacture.

It is remotely possible that the values can become corrupted through electrical noise or an inopportune power outage. If this occurs, the module display will change to figure 2.18.

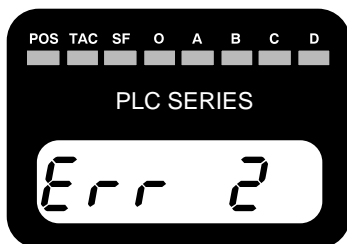

Figure 2.18 nvRAM
Error

This message is displayed at all times. Pressing the [CLEAR] key can clear the error. If the message remains after [CLEAR] is pressed, the nvRAM is damaged. If the message appears on every power up but can be cleared, the battery is discharged. In either case, the module must be returned to AMCI for repairs. See the *Returns Policy* section on the inside front cover for additional information.

Chapter 2 Module Description

Error Messages (continued)

RAM Error

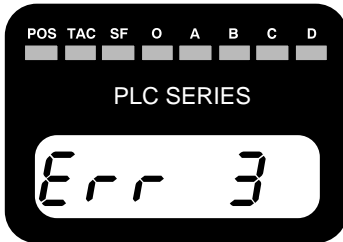

Figure 2.19 RAM Error

This message only appears if there is an unrecoverable RAM fault. The error can not be cleared by any means. When this error message appears, you must return the 2700 module for replacement. See the *Returns Policy* section on the inside front cover for additional information.

Transducer Input Connector

The transducer input connector on each 2700 module has eight contacts. The AMCI part number for the mating connectors is MS-8 and the Phoenix Contact part number is MSTB2.5/8-ST-5.08, 1757077.

Figure 2.20 shows the pinout to industry standard resolver wire designations. Cabling information for AMCI transducers is provided in the *Transducer Cable Installation* section in Chapter 3.

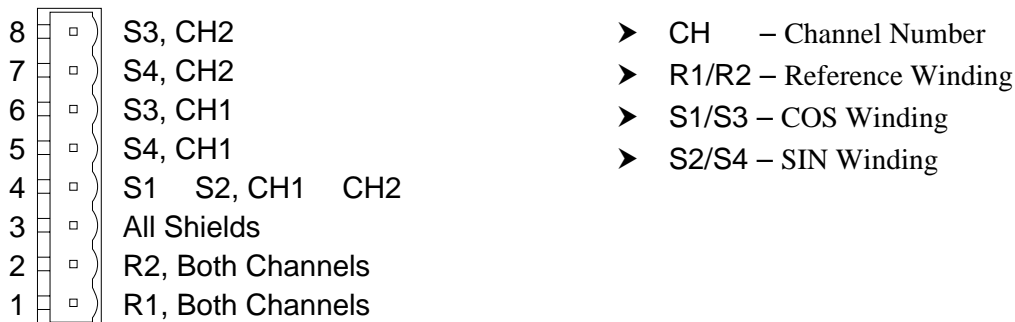
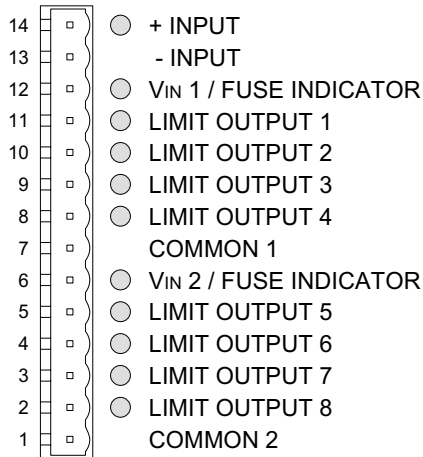

Figure 2.20 Transducer Input Connector

Limit Output Connector

The limit output connector on each 2700 Series module has fourteen contacts. The AMCI part number for the mating connectors is MS-14 and the Phoenix Contact part number is MSTB1.5/14-ST-5.08. A pinout drawing for the limit output connector is provided in the following figure. Note that the position and function of the eleven LED indicators is also shown below.



The input on pins 13 and 14 are not used by the standard 2700 modules. The 2742-18, covered in Appendix A, uses these pins.

All Limit Output Drivers are fuse protected. Fuse 1 protects outputs 1 through 4. Fuse 2 protects outputs 5 through 8. If a fuse blows, the appropriate Fuse Indicator turns on.

A wiring diagram for the Limit Output Connector is given in Chapter 3, *Limit Switch Load Connections*, on page 3-8.

Figure 2.21 Limit Output Connector

Chapter 2 Module Description

Fuse LEDs & Access Cover

Fuse LED 1 is ON when the fuse protecting Outputs 1, 2, 3 and 4 fails, and Fuse LED 2 is ON when the fuse protecting Outputs 5, 6, 7 and 8 fails. Both of these fuses are 7A Fast Blow (Littelfuse 225007) fuses located on the Output PC board attached to the left side cover of the module. To access the fuses, remove the six screws identified below on the left side module cover. There is a ribbon cable toward the top of the module that connects the two internal PC boards. Do not disconnect this cable. When re-assembling the module, do not pinch this cable in the modules' metal work.

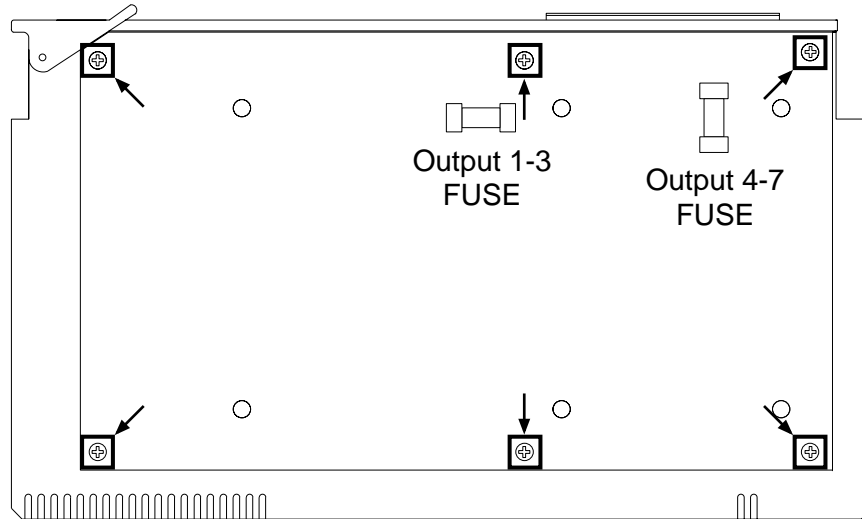

Figure 2.22 Accessing the Output Fuses

This chapter describes how to install a Series 2700 module into an I/O chassis. It also provides information on installing AMCI transducers, including mounting data, specifications, outline drawings, and cable wiring diagrams.

Power Requirements

The 2700 modules draw power from the I/O chassis +5Vdc supply. The maximum current draw is dependent on the number of transducer channels and is listed in Table 3.1. Add this to the current requirements of all other modules in the chassis when sizing the chassis current supply.

Model Number	2731/2741	2732/2742
Maximum Current Draw	675 mA	700 mA

Table 3.1 Backplane Current Draw

An external +12Vdc to +40Vdc power supply is required for the limit outputs. The maximum current draw for all eight outputs is 10 Adc under normal conditions, 14 Adc under fault conditions. *Limit Switch Load Connections* on page 3-8 gives power supply and load wiring information.

Installing the Module



WARNING

Remove system power before removing or installing a module in the I/O chassis. Failure to observe this warning can result in damage to the module’s circuitry and/or undesired operation with possible injury to personnel.



CAUTION

Do not force the module into a backplane connector. If you can not seat it with firm pressure, check the alignment and keying. You can damage the connector or the module if you force it into the connector.

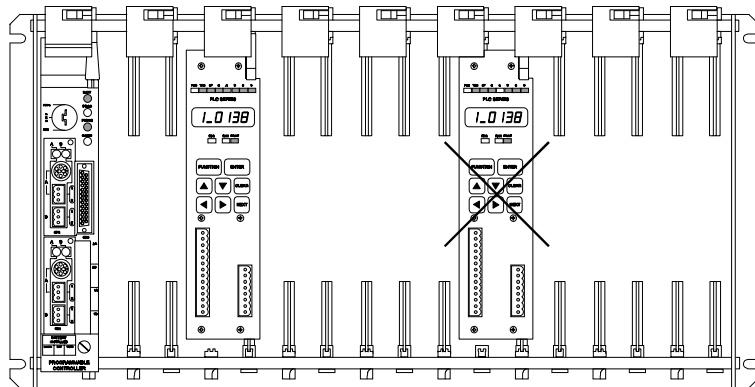

Figure 3.1 Module Installation

1. Remove power from the I/O chassis before inserting (or removing) the module.
2. Open the module locking latch on the I/O chassis shown in Figure 3.1.
3. Insert the module in a single slot pair within the chassis. A slot pair consists of two adjacent backplane slots, the left of which is even numbered. The slots in each A-B chassis are usually numbered on the backplane silkscreen.

NOTE: In Figure 3.1, the module on the left is installed correctly in a single slot pair, while the module on the right is incorrectly installed in two slot pairs.

4. Firmly press the front of the module to seat it into the backplane connector.
5. Secure the module with the module locking latch.

All addressing and programming examples in this manual assume that the module is installed in a single slot pair.

Chapter 3 Installation

Installing the Module (continued)

Keying Bands

Plastic keying bands can be inserted into the top backplane connector to prevent the insertion of other modules. Insert the bands between the following pins:

- Pins 28 and 30
- Pins 32 and 34.

Transducer Specifications

Specification	All HT-20's	All HT-20-(x) HT-400, HT-20-1, & HTT-400-1	All H25's	HT-6	All R11's
Shaft Diameter	0.625"	0.625"	0.375"	0.188"	0.120"
Radial Shaft Loading	400 lbs. max.	400 lbs. max.	40 lbs. max.	8 lbs. max.	2 lbs. max.
Axial Shaft Loading	200 lbs. max.	200 lbs. max.	20 lbs. max.	4 lbs. max.	1 lb. max.
Starting Torque	8 oz-in @ 25°C	8 oz-in @ 25°C	1.5 oz-in @ 25°C	0.5 oz-in @ 25°C	0.1 oz-in @ 25°C
Moment of Inertia (oz-in-sec ²)	6.25×10^{-4}	8.75×10^{-4}	6.00×10^{-4}	2.10×10^{-4}	0.51×10^{-4}
Weight	4 lbs.	4 lbs.	1 lb.	0.7 lb.	0.25 lb.
Enclosure	NEMA 4 or 4X	NEMA 4	NEMA 4	NEMA 13	NEMA 1
Environmental (All Transducers)					
Operating Temp -20 to 125°C	Shock 5 0G's for 11 milliseconds		Vibration 5 to 2000 Hz @ 20 G's		

Table 3.2 Transducer Specifications

Transducer Mounting

All AMCI resolver based transducers are designed to operate in the industrial environment and therefore require little attention. However, there are some general guidelines that should be observed to ensure long life.

- Limit transducer shaft loading to the following maximums:

	Radial Load	Axial Load
All 0.625" Shafts	100 lbs. (445 N)	50 lbs. (222 N)
All 0.375" Shafts	30 lbs. (133 N)	15 lbs. (66.7 N)
All Other Shafts	1 lb. (4.45 N)	0.5 lb. (2.22 N)

Table 3.3 Transducer Bearing Loads

- Minimize shaft misalignment when direct coupling shafts. Even small misalignments produce large loading effects on front bearings. It is recommended that you use a flexible coupler whenever possible. A flexible coupler is *required* for the HT-6 transducer and all R11 resolvers.

Transducer Outline Drawings

AMCI offers a broad line of resolver based transducers for use with the 2700 modules. (See *Compatible Transducers* on page 1-3. Outline drawings for all of these transducers, along with full specification sheets for our most popular transducers, are available on our website, www.amci.com. If you do not have internet access, contact AMCI and we will fax the information to you.

Transducer Cable Installation

Use the table below to determine the correct cable and connectors for your application. Cables that have been assembled and tested are available from AMCI under the given part numbers. If you are making your own cables, cable and connectors can be ordered from AMCI.

Module	AMCI Part #	Belden Cable #		Module Conn.	Transducer Conn.
		-100ft	100ft+		
2731/41	C1T – (x)	9873	9730	MS-8	MS-16 (1)
2732/42	C2T – (x)	9873	9730	MS-8	MS-16 (2)

Table 3.4 Transducer Cable Numbers

NOTE

- 1) Resolvers are low voltage, low power devices. If you are using A-B guidelines for cabling installation, treat the transducer cable as a Category 2 cable. It can be installed in conduit along with other low power cabling such as communication cables and low power ac/dc I/O lines. It cannot be installed in conduit with ac power lines or high power ac/dc I/O lines. Refer to the *Allen Bradley Programmable Controller Grounding and Wiring Guidelines* manual, Publication number 1770-4.1 for more information.
- 2) The shields of the transducer cable must be grounded at the 2700 module *only!* When installing the cable, treat the shield as a conductor. Do not connect the shield to ground at any junction box or the transducer. This will eliminate ground loops that could damage the module or PLC.

Transducer Cable Wiring Diagrams

C1T-(x) Wiring Diagram (2731/2741)

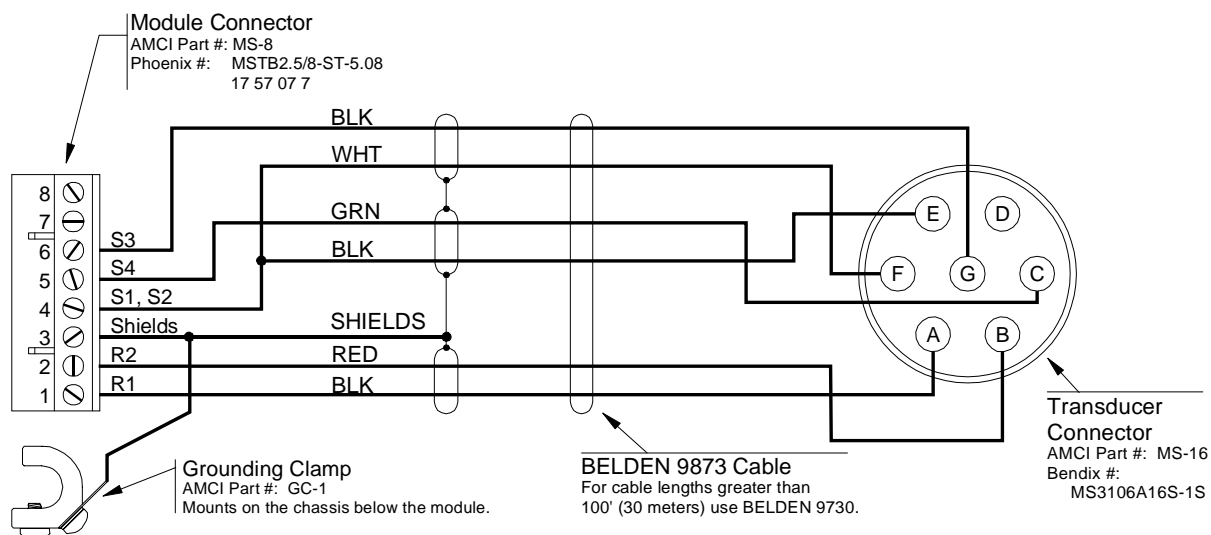

Figure 3.2 C1T-(x) Wiring Diagram with GC-1

Chapter 3 Installation

Transducer Cable Wiring Diagrams (continued)

C2T-(x) Wiring Diagram (2732 / 2742)

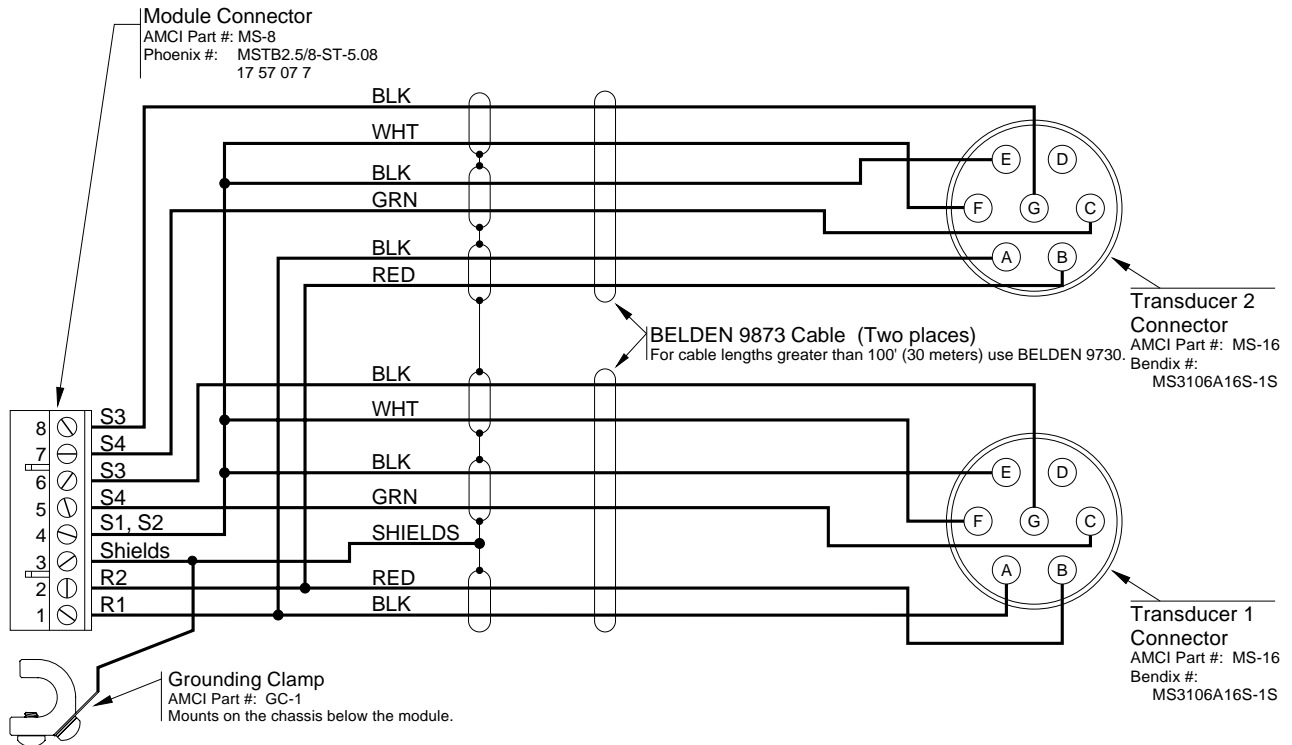

Figure 3.3 C2T-(x) Wiring Diagram with GC-1

GC-1 Grounding Clamp

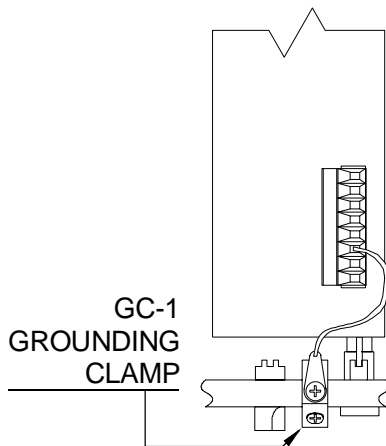
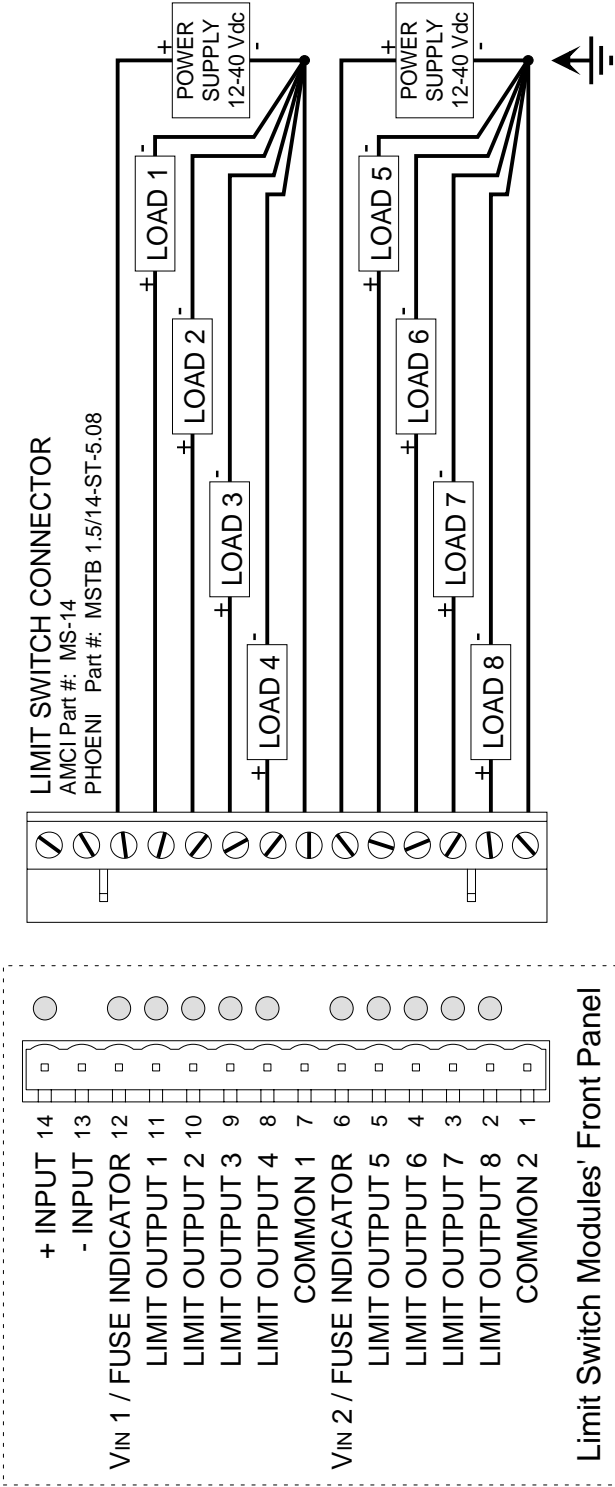

Figure 3.4 GC-1 Clamp

The shield of the transducer cable must be attached to the chassis with a Grounding Clamp (AMCI part number GC-1). This guarantees a low impedance path to ground for any EMI radiation that may be induced into the cable. The drain wire from the Grounding Clamp must be connected to pin 3 of the MS-8. The grounding clamp package includes installation instructions.

Limit Switch Load Connections

The figure below shows how to attach loads to the 2700 Limit Output Connector.



Maximum Current Draw:
 2 A dc per output
 5 A dc per group of four

Surge Rating:
 4 A dc per output for 10 milliseconds

All cabling from the Limit Output Connector must be routed away from the transducer cable to limit the effects of EMI that may be generated by the loads.

All inductive loads, (motors, solenoids, etc.) connected to the limit outputs must have surge suppressors installed across their power terminals.

All return connections from the loads must be as close as possible to the power supply.

If the power supply is to be connected to earth ground, the connection must be made at the supply.

Figure 3.5 Limit Switch Connector Hook-up

Chapter 3 Installation

Notes

This chapter describes how to enter Limit Switch Parameters on the keyboard provided on the front panel of each 2700 module to program the module.

Overview

Instructions describing how to enter Limit Switch Parameters on a 2700 module keyboard are provided in this chapter. Refer to the *Transducer Setup Parameters* section in Chapter 2 for a description explaining how to enter these separate parameters. Remember that a 2700 module must be in the Program Mode as described in the *Program Switch* section in Chapter 2 before a parameter can be entered into the module's memory.

NOTE

It is strongly recommended that you check all the parameters after entering one or more new parameters using the keyboard. This is very important, particularly if the Scale Factor (included in the transducer setup parameters) is changed, since this parameter affects nearly all the other parameters.

Entering Limit Switch Parameters

You may enter ON/OFF limit setpoints and ON/OFF advance values for each of the eight outputs provided by a 2700 module. The Output Number display allows you to select the output that you want to program with ON/OFF limit setpoints, and the Advance Output Number display allows you to select an output to program with ON/OFF Advance values.

Up to eight pairs of ON/OFF limit setpoints may be entered for each output. Each ON setpoint for a specific output represents the Machine Position (i.e., the transducer position reported by the 2700 module) where you want the output to turn ON. The corresponding OFF setpoint represents the Machine Position where you want the output to turn OFF.

NOTE

To compensate for fixed delays in an application, an ON advance value may be entered to force the output to turn ON a specified number of milliseconds before the Machine Position reaches the ON setpoint. This advance compensates for fixed delays in turning ON the system, so the output physically activates at the same ON position regardless of machine speed. An OFF advance value may also be entered to turn the output OFF before the Machine Position reaches the OFF setpoint.

- 1) If you attempt to enter an ON or OFF setpoint that is greater than the current value of the Scale Factor minus one, this incorrect value will be rejected. (The blinking cursor will remain on the six-character display screen.)
- 2) If you are using a 2731, 2732, 2741, or 2742 the module will not allow you to enter an OFF advance greater than the corresponding ON advance. If you try this, the module will not accept the value and the blinking cursor will remain on the display. 2700 modules with a "-04" at the end of the part number do not have this restriction.

Chapter 4 Module Keyboard Programming

Programming New ON/OFF Setpoints

As an example of how to enter new ON/OFF limit setpoints for an output, you could perform the following steps to enter these setpoints for Output 6: Setpoint Pair #1 to 45 ON and 140 OFF and Setpoint Pair #2 to 240 ON and 320 OFF.

1. Press the **[FUNCTION]** key until the illustrated data appears on the front panel display of the module. Note that the “O” LED indicator is illuminated at the top of the panel. This is the Output number display.
2. Press the **[NEXT]** key five times until the number “1” on the six-character display screen is replaced by “6” to allow you to enter ON/OFF setpoints for Output 6.

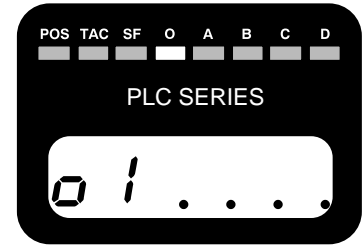

3. Press **[ENTER]** once and the illustrated data should now appear. This is the ON Limit Setpoint display. Note that both the “O” and “C” LED indicators are illuminated and number “6” appears on the left side of the six-character display screen to indicate that you will be entering an ON setpoint for Output 6. Note that the display will show the present setpoint value if one exists.

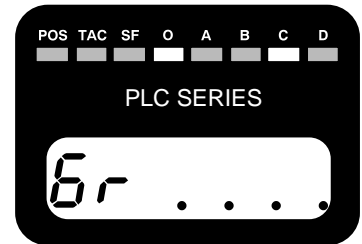

4. To enter an ON setpoint of 45:
 - a) Press the **[▲]** key to change the first digit to a “0” on the left.
 - b) Next, press **[▶]** followed by **[▲]** to move the cursor one digit to the right and change the second digit to a “0” (in the 100’s position).
 - c) Press **[▶]** to move the cursor to the right and press **[▲]** five times to enter a “4” in the next position.
 - d) Press **[▶]** to move the cursor to the last digit and press **[▲]** six times to enter a “5”.
 - e) The illustrated data should now appear on the front panel display.
 - f) Press **[ENTER]** to store the value in nvRAM and remove the blinking cursor.



5. Press **[NEXT]** to go to the OFF Limit Setpoint display shown here. (Note that the “D” LED indicator is illuminated instead of “C”.)
6. To enter an OFF setpoint of 140 in the same pair as the ON setpoint of 45 entered above:

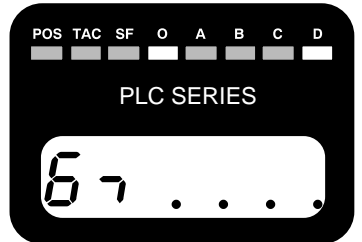

- a) Press **[▲]** to change the first digit to a “0” on the left.
- b) Next, press **[▶]** once and **[▲]** twice to move the cursor to the right and enter a “1” in the 100’s position.
- c) Press **[▶]** to move the cursor right one digit and press **[▲]** five times to enter a “4” in the next position.
- d) Press **[▶]** to move the cursor to the right and press **[▲]** once to enter a “0” in the last position.
- e) The illustrated data should now appear.
- f) Press **[ENTER]** to store the value in nvRAM and remove the blinking cursor.



Programming New ON/OFF Setpoints (continued)

7. Press [NEXT] to begin the process of entering the next ON setpoint for output six. The display shown in Setup 3 will appear again. Note that you can enter up to eight ON/OFF setpoint pairs per output.
8. To enter an ON setpoint of 240:
 - a) Press [▲] to change the first digit to a “0” on the left.
 - b) Next, press [▶] once and [▲] three times to enter a “2” in the 100’s position.
 - c) Press [▶] to move the cursor right and press [▲] five times to enter a “4”.
 - d) Press [▶] followed by [▲] to enter a “0” in the last position.
 - e) The value “0240” should now appear on the right side of the six-character display.
 - f) Press [ENTER] to store the value in nvRAM and remove the blinking cursor.
9. Press [NEXT] to go to the OFF setpoint display shown in Step 5.
10. To enter an OFF setpoint of 320 in the same pair as the ON setpoint of 240:
 - a) Press [▲] to change the first digit to a “0” on the left.
 - b) Press [▶] once and [▲] four times to enter “3” in the 100’s position.
 - c) Press [▶] to move the cursor right and press [▲] three times to enter “2” in the next position.
 - d) Press [▶] followed by [▲] to enter a “0” in the last position.
 - e) The value “0320” should now appear on the right side of the six-character display.
 - f) Press [ENTER] to store the value in nvRAM and remove the blinking cursor.

Modifying Existing ON/OFF Setpoints

You can easily modify an existing ON or OFF limit setpoint for any output. For example, you could change the first OFF setpoint and the second ON setpoint entered for Output 6 in the previous section as follows:

⚠ CAUTION When you change only one setpoint in an ON/OFF pair, you must still “enter” both setpoints. If you do not, the setpoint pair may not be re-initialized correctly in memory until power is cycled to the module.

1. Press [FUNCTION] until the illustrated display appears on the front panel of the module. Note that the “O” LED indicator is illuminated. This is the Output Number display.
2. Press [NEXT] five times until the number “1” on the six-character display screen is replaced by “6” to allow you to modify the ON/OFF setpoints for Output 6.
3. Press [ENTER] once and the illustrated data should now appear. This is the ON Limit Setpoint display. Note that both the “O” and “C” LED indicators are illuminated and the number “6” appears on the left side of the six-character display screen to indicate that you will be modifying setpoints for Output 6.



Modifying Existing ON/OFF Setpoints (continued)

4. Press [ENTER] to accept this value without modification.
5. Press [NEXT] to go to the OFF setpoint in the first pair of setpoints. (Note that when an OFF setpoint is displayed, the “D” LED indicator will be illuminated instead of “C”.) Change the OFF setpoint as desired and press [ENTER] to store the value in nvRAM and remove the blinking cursor.
6. Press [NEXT] again to go to the ON setpoint in the second pair of setpoints. (When an ON setpoint is displayed, the “C” LED indicator will be illuminated instead of “D”.) Change the ON setpoint as desired and press [ENTER] to store the value in nvRAM and remove the blinking cursor.
7. Finally, press [NEXT] one more time to display the OFF setpoint followed by [ENTER] to accept the displayed value (even though you are not changing the value). Note that you must press [ENTER] to accept this value or the new ON setpoint will be ignored.

NOTE

Do not program overlapping pairs of ON/OFF setpoints. For example, 10 to 50 followed by 40 to 60, or 10 to 50 followed by 20 to 30. If one of the pairs is removed or altered, the overlapping part of the other pair will be cleared automatically. In the above example, if you removed the 20 – 30 pair, the software would clear an “OFF space” between 20 and 30 in the first 10 to 50 setpoint pair. To recover from this type of inadvertent error, you must enter the 10 to 50 pair again or cycle power to the module.

Clearing ON/OFF Setpoints

You may clear any pair of ON/OFF setpoints displaying either setpoint in the pair, and pressing [CLEAR]. For example, you could clear a pair of setpoints entered for Output 6 as follows:

1. Press [FUNCTION] until the illustrated data appears on the front panel display of the module. Note that the “O” LED indicator is illuminated. This is the Output Number display.
2. Press [NEXT] five times until the number “1” on the six-character display screen is replaced by “6” to allow you to clear ON/OFF setpoints for Output 6.
3. Press [ENTER] once to go to the illustrated ON setpoint (i.e., 45) for the first setpoint pair entered for Output 6.
4. Now, press the [CLEAR] key to clear the first pair of setpoints for Output 6.

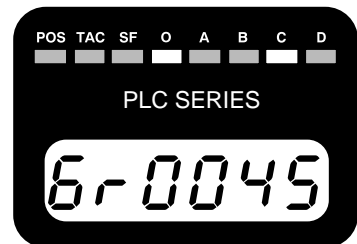
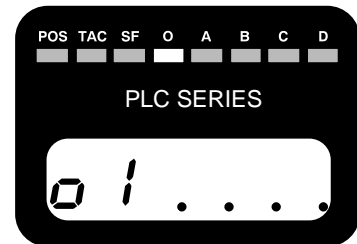

NOTE

To clear the second setpoint pair, first press [NEXT] to return to the Output Number display and then press [ENTER] to go to the ON Limit Setpoint display. The second setpoint pair will be displayed.

Programming ON/OFF Advance Values

As an example of how to enter new ON/OFF advance values for a specific output, you could perform the following steps to enter advance values for Output 4:

1. Press [**FUNCTION**] until the illustrated display appears that allows you to select an output for entering advance values. Note that both the “O” and the “A” LED indicators are illuminated at the top of the display panel. This is the Advance Output Number display.

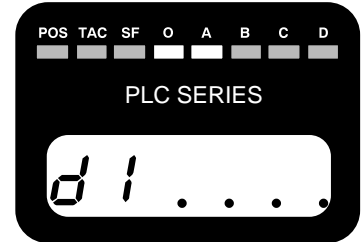

2. Press the [**NEXT**] key three times until the number “1” on the six-character display screen is replaced by “4” to allow you to enter ON/OFF advance values for Output 4.

3. Press [**ENTER**] once and the illustrated data should now appear. Note that the “O”, “A” and “C” LED indicators are illuminated, and number “4” appears on the left side of the six-character display screen with the current ON advance value (in this example, 10) for Output 4 on the right.



4. Change the ON advance value as desired with the cursor keys and press [**ENTER**] to store the value in nvRAM and remove the blinking cursor.

5. Press [**NEXT**] to go to the illustrated display for the OFF advance value. Note that the “O”, “A” and “D” LED indicators are illuminated, and number “4” appears on the left side of the six-character display screen with the current OFF advance value (in this example, 3) for Output 4 on the right.

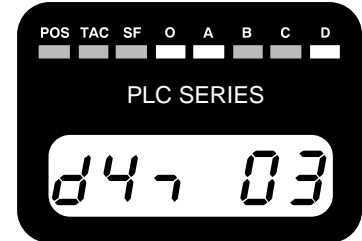

6. Change the OFF advance value as desired with the cursor keys and press [**ENTER**] to store the value in nvRAM and remove the blinking cursor.

NOTE

- 1) You delete advances in the same way that you delete ON/OFF setpoint pairs. Display either the ON advance or OFF advance for the correct output and then press the [**CLEAR**] key.
- 2) The 2731, 2731-04 and 2741 have advances on the first five outputs only. All other modules have advances on all eight outputs.

Chapter 4 Module Keyboard Programming

Notes

This chapter explains how to address a 2700 module in a PLC-5 programmable controller system. If you are using a PLC-2 or PLC-3 system, contact AMCI if you need assistance.

When you configure your programmable controller system, a unique address is assigned to each slot of each chassis in the system. The I/O Rack Number and I/O Group Number make up each address. A block transfer address is further specified with a Module Slot Number.

Note that an I/O Chassis is not the same as an I/O Rack. An I/O Chassis is the physical enclosure for the processor and I/O modules. An I/O Rack Number is part of a modules' address in the system. Each I/O Chassis can have ¼ to 4 I/O Racks associated with it.

Definition of Terms

Block Transfer

The transfer of a block of data over the backplane in one scan. A Block Transfer Read transmits data from an I/O module to the processor. A Block Transfer Write transmits data from the processor to an I/O module. Up to sixty-four words can be transmitted per block transfer.

Single Transfer

The transfer of a single unit (8, 16, or 32 bits) of data over the backplane. The transfer occurs between I/O modules and the processors' Input or Output Image Tables. Of the six 2700 modules, only the 2731-04 uses single transfers.

I/O Rack

The number of I/O Racks, not the number of chassis, define the programmable controller system. In PLC-5 systems the first I/O Rack is assigned the number 0. Each I/O Rack is further divided into 8 I/O Groups.

When specifying a block transfer or single transfer address, all I/O Rack and Group numbers are expressed in octal (i.e. 00, 01, 02, ... 06, 07, 10, 11,).

I/O Group

An I/O Group consists of 16 input and 16 output bits. Eight I/O Groups, numbered 0 through 7, make up a single I/O Rack.

Slot Pair

Backplane slots of an I/O Chassis are numbered consecutively from zero starting at the leftmost *I/O slot*. The processor slot is not numbered. A slot pair is two adjacent backplane slots, the left of which is even numbered. Most A-B chassis have the slot numbers printed on the backplane.

The module must be installed in a single slot pair to operate properly. See chapter 3, page 3-1, *Installing the Module*. The figures in this chapter show the module in a single slot pair.

Chapter 5 AMCI Module Addressing

Definition of Terms (continued)

2-Slot Addressing

Two slot addressing assigns one I/O group to each *slot pair* in the chassis. Block transfers use the I/O group for control bits.

1-Slot Addressing

With 1-slot addressing, one I/O group (16 I/O bits) is assigned to each *slot* in the chassis. Therefore, a 2700 module has two I/O groups in its slot pair, one in each slot. Block transfers use the odd numbered I/O group for control bits. The 2731-04's 16 bit single transfer position data is placed in the odd numbered I/O group.

½-Slot Addressing

With ½-slot addressing, two I/O groups (32 I/O bits) are assigned to each slot in the chassis. Therefore the 2700 has four I/O groups in its slot pair, two in each slot. The 2700 module does not use the first or second I/O groups. Block transfers use the third I/O group (number 2) for control bits. The 2731-04's 16 bit single transfer position data is placed in the fourth (number 3) I/O group.

Addressing the 2700

The processor reads data from the 2700 with block transfer read (BTR) instructions.

The block transfer address is made up of four digits. They are the I/O Rack Number (two digits), the I/O Group Number (one digit), and the Module Slot Number (one digit).

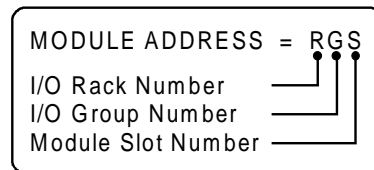

Figure 5.1 BT Module Address

Addressing Shortcuts

- Always base the address on the slot the PC Board plugs into.
- 2-slot address: Slot number always equals one.
- 1-slot address: Group number always odd, slot number always equals zero.
- ½-slot address: Group number always even, slot number always equals zero.

Addressing Examples

The following are examples of module addressing for 2-slot, 1-slot and 1/2-slot configurations. The PLC-5 addresses are also shown.

In the following figures, the module is placed in a single slot pair. See chapter 3, pg. 3-1, *Installing the Module* for more information.

2-Slot Addressing

Rack Number: 00
 I/O Group Numbers: 4
 Module Slot Number: 1
 BT Address: 0041

Note: The 2731-04 cannot be used with 2-slot addressing.

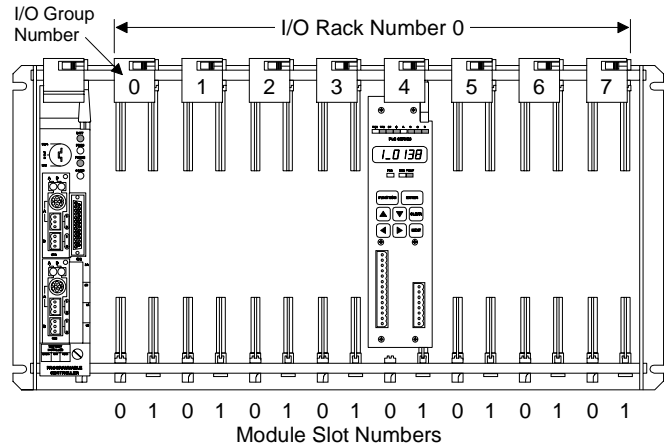

Figure 5.2 2-Slot Address Example

1-Slot Addressing

Rack Number: 01
 I/O Group Numbers: 0,1
 Module Slot Number: 0
 BT Address: 0110

For 2731-04 only:

BT Address: 0110
 Single Transfer Address: I:011

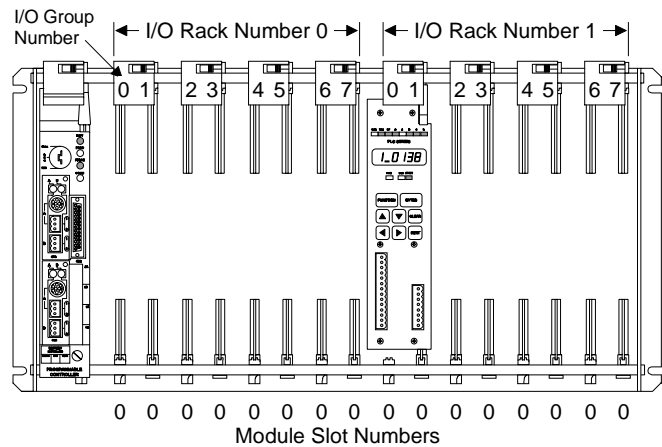

Figure 5.3 1-Slot Address Example

Chapter 5 AMCI Module Addressing

Addressing Examples (continued)

1/2-Slot Addressing

Rack Number: 02
I/O Group Numbers: 2,3
Module Slot Number: 0
BT Address: 0220

For 2731-04 only:

BT Address: 0220
Single Transfer Address: I:023

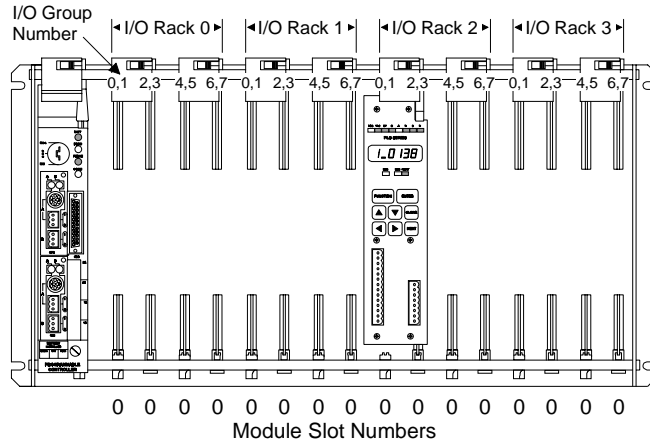

Figure 5.4 1/2-Slot Address Example

Restrictions and Warnings

- The 2700 module must be installed in a single slot pair in order to operate properly. See chapter 3, pg. 3-1, *Installing the Module*.
- When using a 2700 module in a Remote I/O chassis, the I/O Adapter must be a 1771 - ASB, Series B, Firmware Rev. F, or later. Using a Remote I/O Adapter that has an earlier Series or Firmware Revision may not work properly with a 2700 module.

Overview

All PLC-5 processors have Block Transfer Instructions in their instruction sets. There are five parts to PLC-5 BT Instructions. They are:

- › **Module Address** – The I/O rack, I/O group, and module slot numbers where the module is located.
- › **Control Block** – The starting address of the five word block in memory that controls the Block Transfer.
- › **Data File** – The starting address of the file that stores the data written to or read from the module.
- › **File Length** – The number of words needed to store the data written to or read from the module.
- › **Continuous Parameter** – Determines how often the block transfer is carried out.

Module Address

The Module address is the I/O rack, I/O group, and module slot numbers where the module is located in the system. These three numbers are entered separately in the block transfer instruction.

Control Block

The Control Block is a block of five words that control the actual transfer of data. The address entered into the BT instruction is the first address of the block. The control block must have an integer or BT data type and can be its own file or part of a larger file.

Each BT Instruction requires its own control block, even if multiple instructions access the same module.

Data File

The Data File is the block of words that stores information read from or written to the 2700 module. The Data Address is the address of the first word used in the file. The data file must have an integer or binary data type. It can be a separate file or part of a larger file.

File Length**Block Transfer Reads**

The File Length is the number of words in your data file. When programming a BTR instruction, you can set the Block Length to 00. This will reserve 64 words in the PLC-5 memory, but the module will only transmit the number of words necessary. The number of words transmitted depends on the type of module. Table 6.1 lists the number of words transferred based on the module.

2731 / 2741	2732 / 2742
3 words	5 words

Table 6.1 2700 Block Transfer Read Lengths

Chapter 6 PLC-5 BT Instructions

File Length (continued)

Block Transfer Writes

When programming a BTW instruction, you must specify the exact number of words that contain your programming instructions. You cannot use a file length of zero with a BTW instruction unless you are actually transmitting sixty-four words. If you do so, the module will issue an error message to the processor.

Continuous Parameter

The Continuous parameter controls how often the block transfer instruction is executed. When the continuous parameter is set to “NO”, the block transfer is executed only on a false to true transition on the rung. This means that a non-continuous block transfer can occur at most every other scan. When the continuous parameter is set to “YES”, the block transfer will occur when the BT instruction is first scanned and then every scan thereafter until an error in communication occurs.

Block Transfer Writes to a 2700 module *must* have the Continuous Parameter set to “NO”. Continuously writing Program Instructions to the module may interfere with normal operation. **Block Transfer Reads** to a 2700 module can have their Continuous Parameter set to “YES”.

Enable (EN), Error (ER), and Done (DN) Bits

Used to signal the start and finish of a block transfer, the processor sets the EN bit to start the transfer and after successfully completing the transfer the module sets the DN bit. If an error occurs in the transfer, the module will set the ER bit instead of the DN bit.

The EN, ER, and DN bits are located in the first word of the Control File. The EN Bit is bit 15, the ER Bit is bit 12 and the DN Bit is bit 13.

The following warning is taken verbatim from Allen-Bradley's PLC-5 Family Programmable Controllers Processor Manual, Publication 1785-6.8.2 - November, 1987 and refers to the control bits of the BT instruction. These bits include the Enable, Error, and Done bits.

“IMPORTANT: The processor executes block-transfer instructions asynchronous to the program scan. The status of these bits could change at any point in the program scan. When you test these bits (especially the done bit), test them only once every ladder program scan. If necessary, set temporary storage bits for the purpose of enabling subsequent rungs from them.

Also, your ladder program should condition the use of block transfer data on the examination of the block-transfer error bit. An error may occur when the processor is switched from run mode, or when processor communications are interrupted.”

PLC-5 Restrictions and Warnings

- It is important to have the 2700 module installed in a single slot pair. See chapter 3, pg. 3-1, *Installing the Module*.
- When using the 2700 module in a remote chassis, the Remote I/O Adapter must be a 1771 - ASB, Series B, Firmware Rev. F, or later. Using a Remote I/O Adapter that has an earlier Series or Firmware Revision may not work properly with a 2700 module.
- When the processor enables a block transfer, it puts all of the needed information into a queue. A queue is a data structure where the first piece of information put into the queue is the first piece of information taken out. Once the information is queued, a separate part of the processor performs the block transfer while the rest of the processor continues with the program scan. Each I/O rack in the system has its own queue. Each queue can hold 17 BT requests. When the block transfer has its Continuous bit set to 1, Continuous Parameter is “YES”, the Block Transfer is placed permanently in the queue.

Each queue has a “Queue Full” bit in word 7 of the processor's status file. Bit 8 is for Rack 0, Bit 9 is for Rack 1, and so on up to bit 15 for Rack 7. The appropriate bit is set when a queue is full of BT Requests. Once set, your ladder logic program must clear these bits. We recommend that your program monitor these bits and take appropriate action if these bits are set.

If you have more than 17 block transfers associated with one rack and you set all of their continuous parameters to YES, only the first 17 block transfers scanned will be performed. All other transfers cannot be put into the queue and will never be performed.

Chapter 6 PLC-5 BT Instructions

Notes

This chapter outlines the format of the position and tachometer data sent from a 2700 module.

Block Transfer Data Format

When a block transfer read instruction accesses a 2700 module, the module transmits two 16 bit words for each transducer channel and one additional word, the Status Word, that gives programming error and limit switch ON/OFF state information. The Programming Errors byte is usually equal to zero. The only time it will be non-zero is when a programming error exists. If you do not program the module from the backplane, you can safely ignore this byte. Programming the module from the backplane is covered in the next chapter.

2731 / 2731-04 / 2741		
Word 1	E*	Transducer 1 Position Value
Word 2	E*	Transducer 1 Tachometer Value
Word 3	Programming Errors	LS Status

E* Error bit. When there is a transducer or nvRAM fault, the module transmits 8000h (1000 0000 0000 0000b) in place of position and tachometer data. This is the only time the most significant bit of a position data word is set. If the error is a transducer fault, only the words of the faulted channel are changed. If the error is a nvRAM fault, all of the data words are changed.

2732 / 2732-04 / 2742		
Word 1	E*	Transducer 1 Position Value
Word 2	E*	Transducer 1 Tachometer Value
Word 3	E*	Transducer 2 Position Value
Word 4	E*	Transducer 2 Tachometer Value
Word 5	Programming Errors	LS Status

➤ All position and tachometer data is transmitted in binary format.

Figure 7.1 Data Format

Single Transfer Data Format (2731-04 only)

In addition to the block transfer data listed above, the 2731-04 also transmits the position data using a 16 bit single transfer. The position data is in binary format and has a maximum value of 1023. If there is a transducer fault, the position data changes to 8000h, which means only the most significant bit is set. A transducer fault is the only time this bit will be set, so you can easily test for a transducer fault with a single contact instruction.

Chapter 7 Data Format

Notes

This chapter contains all of the information needed to learn how to use block transfer writes to program a 2700 module from the backplane. This information includes data on programming structure, programming instructions, and error codes.

Programming Structure

You program a 2700 module by sending it a series of *Program Instructions* with a block transfer write. Each program instruction is made up of a *Command Word* and zero or more *Data Words*. Block transfers can transmit a maximum of sixty-four words at one time. Therefore, programming a 2700 module may require more than one block transfer.

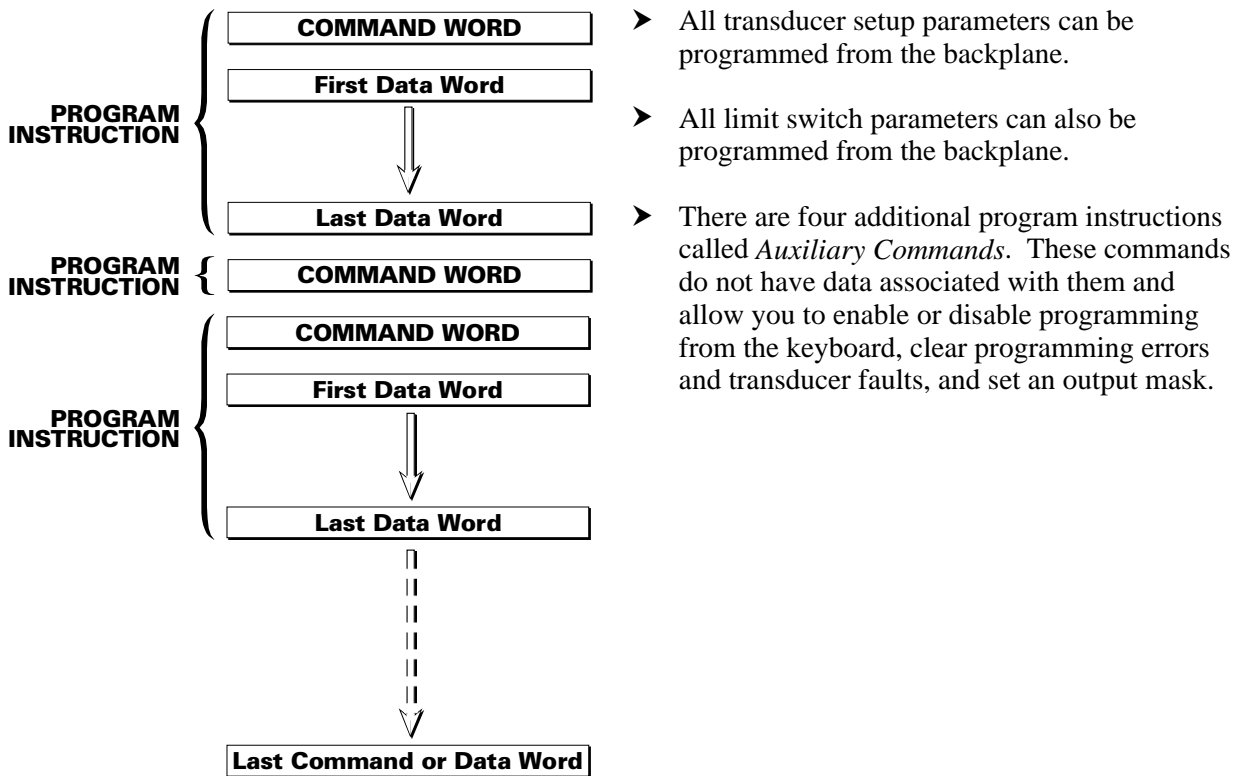

Figure 8.1 2700 Programming Structure

A 2700 module decodes instructions one at a time. If the module encounters an error with an instruction it will stop processing the instructions and issue an error. An instruction must be completely correct before the module accepts it. Therefore, if you write an instruction to change three parameter values and the second value is incorrect, none of the parameters will be changed. If you write multiple instructions to the module with one block transfer write and one of the instructions is incorrect, that instruction, and all that follow it, will be ignored.

Chapter 8 Backplane Programming

Program Instructions

Program Instructions are broken down into three categories

- **Auxiliary Commands** – Four instructions that affect the operation of the module and do not have data words associated with them. These instructions are:
 - Disable Keyboard Programming
 - Enable Keyboard Programming
 - Set Output Mask
 - Clear Errors
- **Transducer Setup Instructions** – Three instructions that program the transducer setup parameters for 2700 modules with one or two transducers. If you attempt to program parameters for a transducer channel that does not exist on your module, it will respond with a programming error code.
- **Limit Switch Instruction** – A single instruction with up to 17 data words that may be entered for each of the eight limit outputs to enter setpoints and advance values for the output.

Auxiliary Commands

Command	Command Word	Comments
Disable Keyboard	8100h	Disables all programming from the keyboard. Parameter values can be inspected but they cannot be changed. This instruction protects 2700 modules from unauthorized access in the field.
Enable Keyboard	8200h	This command counteracts a previous Disable Keyboard command. The status of the keyboard programming disable command is retained when power is removed. The only way to enable keyboard programming after a Disable Keyboard command is with this instruction.
Set Output Mask	8300-FFh	Use this command to selectively disable one or more outputs. Each output is controlled by one bit. Output 1 is controlled by bit 0 (LSB) and Output 8 by bit 7 (MSB). When a zero is written in the bit, the output is always off. When a one is written in the bit, the output is on or off based on the programmed limits and advance values.
Clear Errors	8400h	This command clears all programming errors and transducer faults.

Table 8.1 Auxiliary Commands

Transducer Setup Instructions

Command	Command Word	Comments																		
Store Transducer Parameters 2731 2741	88XYh	<p>(X = {0}, Y = {1...7}). Use this instruction to store transducer setup parameters for the 2731 and 2741.</p> <div style="text-align: center;"> <table border="1" style="margin: auto; border-collapse: collapse;"> <tr style="background-color: #cccccc;"> <th colspan="5">Digit X</th> <th colspan="4">Digit Y</th> </tr> <tr> <td style="text-align: center;">0</td> <td style="text-align: center;">0</td> <td style="text-align: center;">0</td> <td style="text-align: center;">0</td> <td style="text-align: center;">0</td> <td style="text-align: center;">0</td> <td style="text-align: center;">0</td> <td style="text-align: center;">0</td> <td style="text-align: center;">0</td> </tr> </table> <div style="margin-top: 10px;"> <div style="display: flex; justify-content: center; gap: 20px;"> <div style="text-align: center;"> <p>Scale Factor Circular Offset Tachometer Response Reserved: Must equal zero.</p> </div> </div> </div> </div> <p>Bit set to "1" = Store new parameter value. Bit reset to "0" = Leave parameter value as is.</p> <p style="background-color: #cccccc; padding: 5px;">EXAMPLE: 8801h = Store new Scale Factor.</p> <p>The new parameter values are stored as Data Words immediately after the Command Word. New values are stored in BCD format. The order is:</p> <ul style="list-style-type: none"> Scale Factor (Changing resets the Circular Offset.) Circular Offset Tachometer Response <p>The module checks the validity of each new parameter value. Valid ranges are:</p> <ul style="list-style-type: none"> Scale Factor: 2 to 1,024 (2731), 2 to 4,096 (2741) Circular Offset: 0 to (Scale Factor -1) Tach Response: 0 to 4 <ul style="list-style-type: none"> 0 = 30 milliseconds Response 1 = 60 milliseconds Response 2 = 120 milliseconds Response 3 = 240 milliseconds Response / 1.0 RPM Resolution 4 = 240 milliseconds Response / 0.1 RPM Resolution <p style="background-color: #cccccc; padding: 5px;">PROGRAMMING EXAMPLE</p> <p>Set the Circular Offset to 90, and the tach response to 120 milliseconds. Command Word: 8806h Data Words: 0090h Circular Offset 0002h Tach Response</p>	Digit X					Digit Y				0	0	0	0	0	0	0	0	0
Digit X					Digit Y															
0	0	0	0	0	0	0	0	0												

Table 8.2 2731/41 Transducer Setup Instruction

Chapter 8 Backplane Programming

Transducer Setup Instructions (continued)

Command	Command Word	Comments
Store Transducer Parameters 2732 2742	88XYh (Store for Transducer 1)	<p>(X = {0}, Y = {1...7}). Use this instruction to store transducer setup parameters for modules 2732 and 2742.</p> <p>Note: Using this command to program both transducers at one time requires a pair of Data Words for each parameter. This implies that only the same parameters can be programmed for both transducers with the same instruction. The first Data Word in every pair of words is for Transducer 1, and the second word is for Transducer 2.</p> <p>EXAMPLE: 9801h = Store new Scale Factor, Transducer 2</p> <p>The new parameter values are stored as Data Words immediately after the Command Word. New values are stored in BCD format. The order is:</p> <ul style="list-style-type: none"> Scale Factor (Changing resets all offsets and preset value to 0) Circular Offset Output Allocation / Tachometer Response <p>The module checks the validity of each new parameter value. Valid ranges are:</p> <ul style="list-style-type: none"> Scale Factor: 2 to 1,024 (2732), 2 to 4,096 (2742) Circular Offset: 0 to (Scale Factor -1) Output Allocation/ Tach Response: 00 to 84
	98XYh (Store for Transducer 2)	
	A8Xyh (Store for both transducers)	
The Table Is Continued On the Next Page.		

Transducer Setup Instructions (continued)

Continued From Last Page		
Store Transducer Parameters 2732 2742	88XYh (Store for Transducer 1) 98XYh (Store for Transducer 2) A8XYh (Store for both transducers)	<p>The Output Allocation and Tachometer Response are programmed with a single word. The Tachometer Response is programmed in the lower byte (Bits 0-7) and the Output Allocation value is in the upper byte of the word (Bits 8-15). The Tachometer Response is a numeric value from 0 to 4 that sets the tachometer to one of five values. The Output Allocation value is the number of outputs assigned to transducer 1. The remaining outputs are assigned to transducer 2. The output allocation is only available when programming the first transducer.</p> <p>Lower Byte: 00h = 30 mS Response 01h = 60 mS Response 02h = 120 mS Response 03h = 240 mS Response / 1.0 RPM Resolution 04h = 240 mS Response / 0.1 RPM Resolution</p> <p>Upper Byte: 00h = 0 outputs assigned to Transducer 1, Outputs 1-8 assigned to Transducer 2 01h = Output 1 assigned to Transducer 1, Outputs 2-8 assigned to Transducer 2</p> <p style="text-align: center;">↓</p> <p>07h = Outputs 1-7 assigned to Transducer 1, Output 8 assigned to Transducer 2 08h = Outputs 1-8 assigned to Transducer 1, 0 outputs assigned to Transducer 2</p>
		<p>PROGRAMMING EXAMPLE - Both Transducers</p> <p>Transducer 1: Scale Factor = 360, Circular Offset = 90, Output Allocation = 4 and Tach Response = 120 milliseconds.</p> <p>Transducer 2: Scale Factor = 720, Circular Offset = 600, and Tach Response = 60 milliseconds</p> <p>Command Word: A807h</p> <p>Data Words: 0360h Scale Factor: Transducer 1 0720h Scale Factor: Transducer 2 0090h Circular Offset: Transducer 1 0600h Circular Offset: Transducer 2 0402h Output Allocation / Tach Response: Transducer 1. Outputs 1-4 assigned to Transducer 1. Outputs 5-8 assigned to transducer 2 0001h Tach Response: Transducer 2</p>

Table 8.3 2732/42 Transducer Setup Instructions

Limit Switch Instruction

Command	Command Word	Comments																	
Store ON/OFF Setpoints and Advance Values	C0XYh	(X = {1...8}, Y = {1...8}). Use this instruction to program a limit switch's ON/OFF advances and ON/OFF setpoints.																	
		<table border="1" style="margin-left: auto; margin-right: auto;"> <tr> <th colspan="4">Digit</th> <th colspan="4">Digit Y</th> <th rowspan="2">Bit Number</th> </tr> <tr> <td>7</td><td>6</td><td>5</td><td>4</td> <td>3</td><td>2</td><td>1</td><td>0</td> </tr> </table> <p style="margin-left: 100px;">Use these four bits to enter the number of ON/OFF setpoint pairs defined for this output.</p> <p style="margin-left: 100px;">Use these four bits to enter the number of the limit switch output to be programmed.</p>	Digit				Digit Y				Bit Number	7	6	5	4	3	2	1	0
		Digit				Digit Y				Bit Number									
7	6	5	4	3	2	1	0												
<p>EXAMPLE: C065h = This instruction programs the advances and five ON/OFF setpoint pairs for Output 6.</p>																			
		<p>The new parameter values are stored as Data Words immediately after the Command Word. New values are stored in BCD format. The order of the words is:</p> <p>Word 1: ON Advance / OFF Advance The ON Advance is in the upper byte of the word and the OFF Advance is in the lower byte.</p> <p>Word 2: ON Setpoint 1 Word 3: OFF Setpoint 1 Word 4: ON Setpoint 2 Word 5: OFF Setpoint 2</p> <p>Up to six more setpoint pairs may be specified in Data Words 6 through 17.</p> <p>The modules check the validity of each new parameter value. Valid ranges are:</p> <p>ON Advance: 0 to 99 milliseconds OFF Advance: Less than or equal to ON Advance for same Output ON Setpoint: 0 to (Scale Factor -1) OFF Setpoint: 0 to (Scale Factor -1)</p>																	

Table 8.4 Limit Switch Instruction

NOTE If you are using the 2731 or 2741, ON/OFF Advances only exist on the first five outputs. When writing programming data to the module for limits 6, 7, and 8, use a value of 0000h for the ON/OFF Advance word.

When using a 2741 or 2742 use caution when re-programming the limits while the machine is running. The outputs may become unpredictable for up to 20 milliseconds while the internal data table is updated. This note does not apply to the 2731 or 2732.

When using advances on a 2731 or 2732, the position values must be increasing for the advances to work correctly. This note does not apply to the 2741 or 2742.

Programming Error Byte

As shown in Figure 7.1 on page 7-1, the 2700 module transmits programming error information in the BTR data. This Programming Error Byte is located in the upper byte (bits 08-15) of the Status Word. Table 8.5 below lists the error codes that can be transmitted.

Program Error	Error Byte	Comments
No Errors	00h	All of the Programming Instructions sent with the last BTW were accepted without errors.
Invalid Command	21h	The Command Word of an instruction is incorrect. Usually occurs when a data word is interpreted as a command word. For example, a Transducer 1 Setup instruction specifies three new parameters and four are included. The fourth instruction will be interpreted as a command word. Another common cause of this error is sending a Command Word of 0000h to the module.
Invalid Message Length	22h	The final instruction of the block transfer write file does not contain enough data words to complete the instruction. Check the <i>length</i> parameter of the block transfer write.
Message Ignored	24h	You attempted to write a program instruction to the module while it was reporting a programming error.
Invalid SF	41h	The programmed scale factor is out of range for Transducer 1.
Invalid CO	42h	The programmed Circular Offset is out of range for Transducer 1.
Invalid TR	44h	The programmed tachometer response value is out of range for Transducer 1.
Invalid OA	48h	The programmed output allocation value is out of range.*
Invalid SF	51h	The programmed scale factor is out of range for Transducer 2.*
Invalid MO	52h	The programmed Circular Offset is out of range. for Transducer 2.*
Invalid TR	54h	The programmed tach response value is out of range for Transducer 2.*
Invalid LS	8nh	The limit switch number is outside of its range of 1 to 8 (“n” is the hexadecimal code entered for the output number).
Invalid SP	Anh	The number of ON/OFF setpoint pairs is outside its range of 1 to 8 (“n” is the hexadecimal code entered for the number of pairs).
Invalid ON	Cnh	A programmed ON setpoint is outside its range of 0 to (Scale Factor -1) (“n” is the number of the limit output).
Invalid OF	Dnh	A programmed OFF setpoint is outside its range of 0 to (Scale Factor -1) (“n” is the number of the limit output).
Invalid OA	Enh	A programmed ON advance value is outside its range of 0 to 99. (“n” is the number of the limit output). On 2731 and 2741, limit switches 6, 7, and 8 do not have advances. The advance value for these limits must equal zero.
Invalid FA	Fnh	A programmed OFF advance value is outside its range of 0 to 99. (“n” is the number of the limit output). On 2731 and 2741, limit switches 6, 7, and 8 do not have advances. The advance value for these limits must equal zero.

*Only applies to 2732 and 2742 modules.

Table 8.5 Programming Error Codes

Error Message Restrictions and Warnings

- Only the first error encountered in an instruction will be displayed to the user.
- No message is accepted by a 2700 module until any previous errors are cleared by a “Clear Errors” instruction. If an attempt is made to send additional instructions they will be ignored.
- Instructions can be mixed in an arbitrary sequence.
- The Err1, Err2, and Err3 messages will set the limit outputs to the OFF state.
- If a programming error is encountered within a sequence of instructions, the instructions preceding the error will be accepted and the rest of the instructions will be rejected.

2700EXAMPLE.RSP

LAD 2 - --- Total Rungs in File = 4

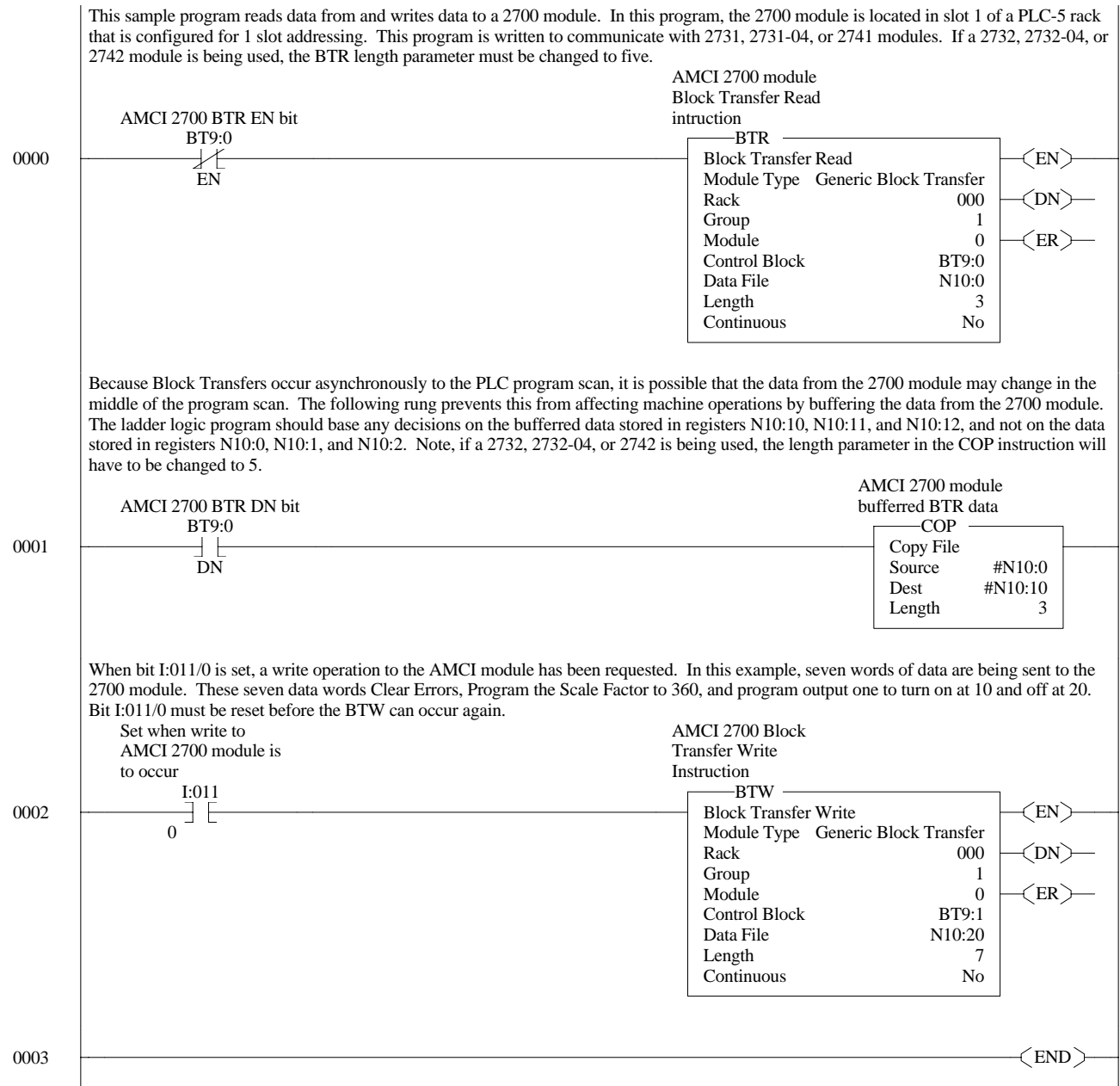

Chapter 9 Sample PLC-5 Program

2700EXAMPLE.RSP

File N10 (dec)

Offset	0	1	2	3	4	5	6	7	8	9
N10:0	155	0	0	0	0	0	0	0	0	0
N10:10	155	0	0	0	0	0	0	0	0	0
N10:20	-31744	-30719	864	-16367	0	16	32			

Description of Option

These instructions assume a reader already familiar with the 2700 User Manual. Refer to the manual for most information on the 2742-18. These instructions describe the functionality the -18 option adds to the 2742 module.

The 2742-18 is a software and hardware modification to the standard 2742. The module does not cycle its outputs until it detects a trigger on an input. The 2742-18 has two inputs, one for each transducer channel. The output allocation is fixed at four outputs per channel. A single channel application is shown below. This is for clarity only. The 2742-18 is a true two channel PLS that updates both channels simultaneously.

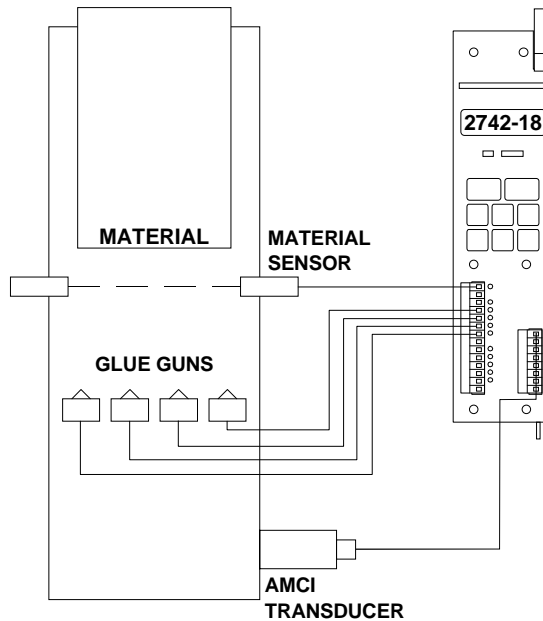

The material sensor detects the leading edge of the material as it travels down the line. The 2742-18 will not fire its outputs until the sensor activates. The module will then fire its limits for at least one cycle. The cycle lasts for a programmable length, the *Cycle Length*, which has a maximum of one complete transducer rotation.

The sensor input can be edge triggered or level triggered. When edge triggered, the module will cycle its outputs once and wait for another edge. When level triggered, the 2742-18 will cycle its outputs for as many cycles as the input is active. The edge or level that the 2742-18 cycles its outputs on is programmable from the keyboard and backplane.

The sensor input does not affect the machine position defined by the transducer and reported over the backplane. When the input activates, the 2742-18 calculates a new position value called the LS Position. The firing of the limit switch outputs is then based on the LS Position. The LS Position is set to zero when the input is activated.

Appendix A 2742-18 Additional Instructions

New Parameters

The 2742-18 has three new parameters that are programmable from the keyboard or backplane. The displays for these parameters are shown below with a brief description of the parameter. When using the [FUNCTION] key to cycle through the menu system, these displays appear before the Limit Switch Setpoints display. The parameters are programmed from the backplane with a modified Transducer Setup Command. The format of the new Transducer Setup Command is given starting on page A-6.

Input Polarity and Output Trigger

The *Input Polarity* and *Output Trigger* parameters together define how the outputs will cycle based on the input. The table below shows the four possible combinations and the resulting behavior.

Polarity	Trigger	Result
Positive	Edge	Outputs cycle once when a logic 0 to 1 transition is made on the input. The 2742-18 ignores the logic 1 to 0 transition and will not cycle its outputs until another positive transition. All positive transitions made before a cycle completes are ignored.
Negative	Edge	Same as Positive Edge triggering above except a logic 1 to 0 transition initiates the cycle.
Positive	Level	Outputs begin to cycle when a logic 0 to 1 transition is made on the input. The outputs will cycle as long as the input is a logic 1. Once initiated, a cycle will complete regardless of the state of the input.
Negative	Level	Same as above except a logic 1 to 0 initiates the first cycle and a logic 0 keeps the outputs cycling.



Do not change these parameters while the outputs are cycling. Any changes made to these parameters are ignored until the cycling completes.

The front panel displays for the two parameters are shown below. Use the [FUNCTION] key to cycle to the display. Use the [▲] and [▼] keys change the value of the parameter. Use the [ENTER] key to store the value. The [NEXT] key switches between the two channels.

INPUT POLARITY

OUTPUT TRIGGER



Positive
Input Polarity



Negative
Input Polarity



Edge
Output Trigger



Level
Output Trigger

New Parameters (continued)

Cycle Length

Cycle Length specifies the number of counts in a single output cycle. Programming the channel 1 Cycle Length erases the limit setpoints for outputs 1 - 4. Programming the channel 2 Cycle Length erases the limit setpoints for outputs 5 - 8. Therefore, program this parameter before programming any limit setpoints.

When programming limit setpoints, the 2742-18 will not accept setpoints that equal or exceed the Cycle Length parameter.

When the outputs are edge triggered, Cycle Length specifies the count that the LS Position must reach before the input becomes edge sensitive again. Once a cycle is started, all transitions on the input are ignored until the LS Position equals the Cycle Length parameter.

When the outputs are level triggered, the Cycle Length specifies the count that the LS Position returns to zero. Therefore, you can run multiple packages that are less than one transducer rotation in length.



The front panel display of the Cycle Length parameter is shown below. Use the [FUNCTION] key to cycle to the display. It appears after the Output Trigger Parameter. Use the [◀], and [▶] keys to move the cursor and the [▲] and [▼] keys to change the value of the digit under the cursor. The [ENTER] key stores the value. The [NEXT] key switches between the two channels.

Programming the Scale Factor will also change the Cycle Length. When the Scale Factor is programmed, the Cycle Length is set equal to the Scale Factor Value.

Limit Switch Programming

The 2742-18 places some restrictions on setpoint programming in order to operate correctly.

- ▶ A limit's ON/OFF Setpoints cannot be greater than or equal to the Cycle Length. A limit's ON/OFF Setpoints are not allowed to pass through zero. (I.e., The ON Point cannot be greater than the OFF Point.) For example, a limit switch cannot be programmed to turn on at 350, off at 10.

When programming from the keyboard:

Setpoints greater than or equal to Cycle Length are not accepted. The 2742-18 will also not accept an OFF Setpoint that is less than its corresponding ON Setpoint.

When programming from the backplane:

Setpoints greater than or equal to Cycle Length will cause an 'Invalid ON Setpoint' or 'Invalid OFF Setpoint' error. Programming a through zero limit will cause an 'Invalid OFF Setpoint' error.

- ▶ Normal machine motion must produce increasing position values. If the position values decrease, reverse the GRN/BLK pair of wires on the transducer cable.
- ▶ Do not change setpoints on the fly. A table internal to the 2742-18 is updated whenever a setpoint is changed. The outputs are frozen in their last state until the changes are complete. Guaranteed to be under 250 milliseconds, the actual time it takes to update the table depends on the number of setpoint changes.

Appendix A 2742-18 Additional Instructions

Limit Switch Output Diagrams

The diagrams below and on the following page show how the outputs fire when the input is edge or level sensitive.

Edge Triggered

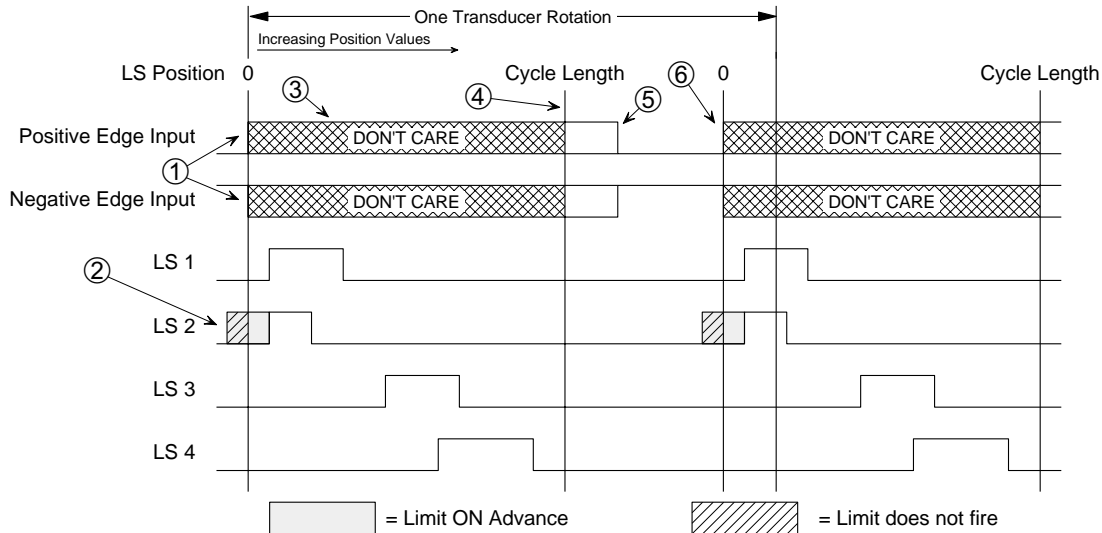

- ① The programmed edge triggers an output cycle. LS Position is set to zero.
- ② LS 2 turns on immediately because it is advanced through zero by its ON advance. Note that LS 2 cannot fire correctly at this speed because of its ON advance. A possible solution is to move the material sensor so that it detects the material earlier, increase the cycle length and change the limit switch programming so that they turn on later in the output cycle.
- ③ All transitions on the input are ignored while the outputs are cycling.
- ④ The input becomes edge sensitive at this point, when the LS Position equals the Cycle Length parameter.
- ⑤ If it did not occur during the cycle, this edge is ignored by the 2742-18.
- ⑥ The programmed edge begins the output cycle again. Note that the second cycle can begin before the transducer completes a complete rotation.

Limit Switch Output Diagrams (continued)

Level Triggered

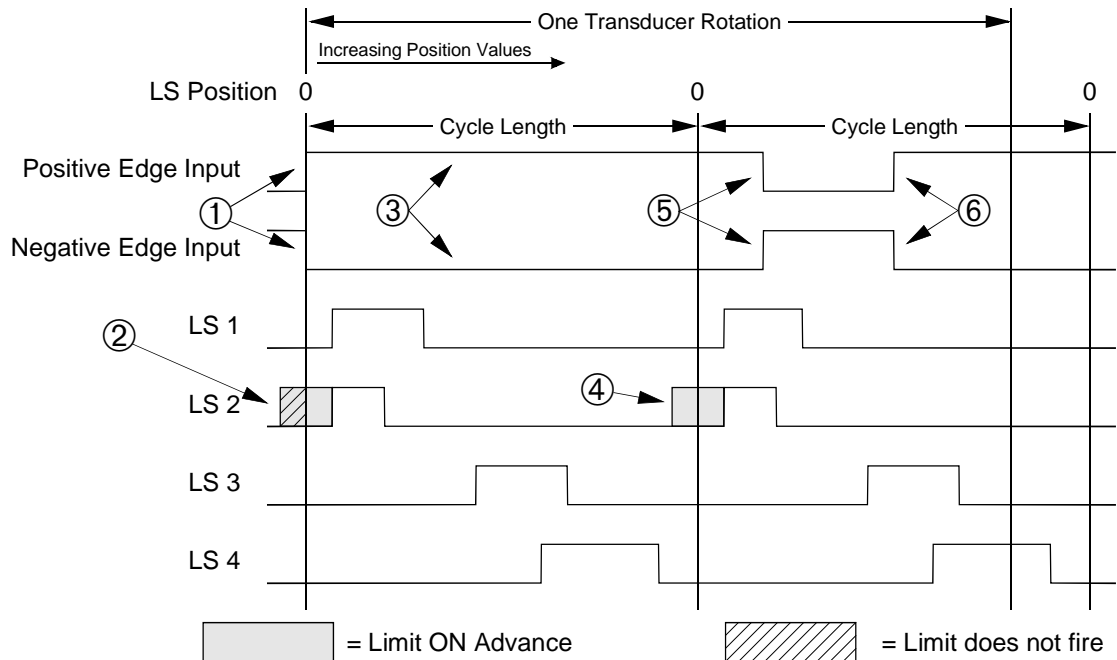

- ① The transition to the programmed level triggers an output cycle. LS Position is set to zero.
- ② LS 2 turns on immediately because it is advanced through zero by its ON advance. Note that LS 2 cannot fire correctly on the first cycle at this speed because of its advance.
- ③ The input must stay at its programmed level to trigger another cycle after the present one completes.
- ④ LS 2 is the first limit to turn on in a cycle because of its ON advance. Note that it fires before the present cycle is complete.

! CAUTION

If you use limits that are advanced through zero, (LS 2 in the example above), you must exercise caution when using a level triggered input. The input must not change state from the point the limit starts firing (④ above) until the cycle is complete. If it does change state, the limit will not fire correctly.

- ⑤ This transition signals that the present cycle is the last to fire.
- ⑥ Because the transition to the programmed level occurs before the present cycle is complete, it is ignored. The outputs will not cycle again until the next transition to the programmed level after the outputs finish cycling.

Appendix A 2742-18 Additional Instructions

BTR Data Format

The block transfer read data format is shown below.

Hex Bit	15	14	13	12	11	10	09	08	07	06	05	04	03	02	01	00
Octal Bit	17	16	15	14	13	12	11	10	07	06	05	04	03	02	01	00
Word 1	T1		12 Bit Position Value, Transducer 1													
Word 2	T1		IN1		14 Bit Tachometer Value, Transducer 1											
Word 3	T2		12 Bit Position Value, Transducer 2													
Word 4	T2		IN2		14 Bit Tachometer Value, Transducer 2											
Word 5	Error Message								Limit Output State							

Status Bits:

- T1, T2: When there is a transducer fault condition, the hexadecimal number 8000, (1000 0000 0000 0000 BIN), is sent to the CPU in place of the Position and Tachometer values. This is the only time bit 16 of a position or tachometer word is set by the 2742-18 Module so the bit can be used for efficient error detection. Only the words of the affected transducer are changed.
- IN1, IN2: Set when the corresponding input has power applied to it. The values of the Input Polarity and Output Trigger parameters are not considered when determining the values of these bits.

Notes:

Because both the Position and Tachometer values are less than 16 bits in length, both have preceding zeros to complete the 16 bit words.

14 bit Tachometer data occurs when the Tachometer Response parameter is set to 240 milliseconds with 0.1 RPM resolution. The maximum data value with this response is 9999. (999.9 RPM)

Information on the Error Message / Limit Output State word is available on page 8-7. Also see the *Backplane Programming Error Codes* section of this manual (pg. A-9) for information on the additional error codes reported in the Error Message byte.

Backplane Programming

The new parameters are written to the 2742-18 module with the *Transducer Setup Commands*. The Transducer Setup Commands are modified as outlined below.

Transducer 1 Setup: Command Word = 880Xh (X = {1 ... F})

Use this instruction to program the Scale Factor, Circular Offset, Tach Response, Input Polarity, Output Trigger, and Cycle Length parameters for Transducer 1.

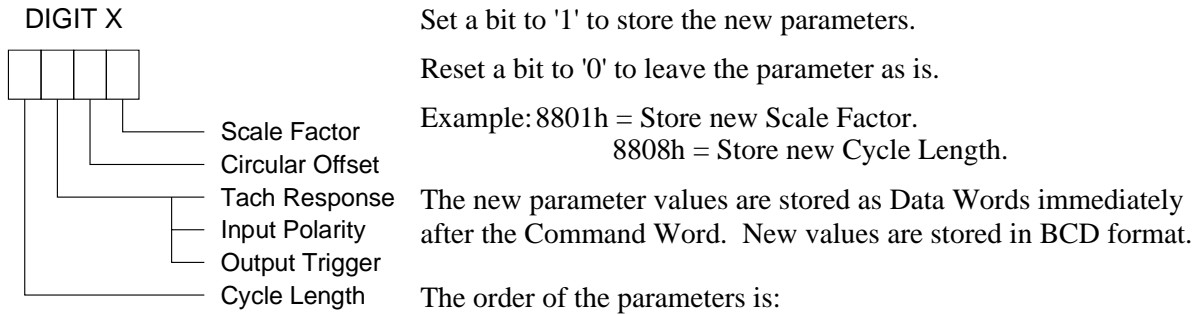

- **Scale Factor 1**
Changing Scale Factor 1 resets the following:
Circular Offset 1 is reset to zero.
Cycle Length 1 is set equal to Scale Factor 1.
- **Circular Offset 1**
- **Input Polarity 1 / Output Trigger 1 / Tach Response 1**
- **Cycle Length 1**
Changing Cycle Length 1 erases all limit setpoints for outputs 1 - 4.

The Tach Response, Input Polarity, and Output Trigger are stored in a single word. Input Polarity and Output Trigger are in the high byte, Tach Response is in the low byte. All three parameters must be transferred, even if you are only changing one.

Valid parameter values are:

Scale Factor:	2 to 4096.
Circular Offset:	0 to (Scale Factor - 1)
Tach Response:	0 to 4 (Low Byte of word)
	0 = 30 milliseconds Response
	1 = 60 milliseconds Response
	2 = 120 milliseconds Response
	3 = 240 milliseconds Response / 1.0 RPM Resolution
	4 = 240 milliseconds Response / 0.1 RPM Resolution
In Polarity / Out Trigger:	0 to 3 (High Byte of word)
	0 = Positive Polarity, Edge Triggered
	1 = Positive Polarity, Level Triggered
	2 = Negative Polarity, Edge Triggered
	3 = Negative Polarity, Level Triggered
Cycle Length:	1 to (Scale Factor)

Appendix A 2742-18 Additional Instructions

Backplane Programming (continued)

Transducer 2 Setup: Command Word = 980Xh (X = {1 ... F})

Use this instruction to program the Scale Factor, Circular Offset, Tach Response, Input Polarity, Output Trigger, and Cycle Length parameters for Transducer 2. The data format is the same as the Transducer 1 Setup Command. Note that programming the Scale Factor 2 resets Circular Offset 2 to zero, sets Cycle Length 2 to the Scale Factor 2 value, and erases all programmed limit setpoints for outputs 5 - 8.

Transducer 1 & 2 Setup: Command Word = A80Xh (X= {1 ... F})

Use this instruction to program the Scale Factor, Circular Offset, Tach Response, Input Polarity, Output Trigger, and Output Delay parameters for both transducers. The order of the data words is:

- Scale Factor 1
- Scale Factor 2
- Circular Offset 1
- Circular Offset 2
- Input Polarity 1 / Output Trigger 1 / Tach Response 1
- Input Polarity 2 / Output Trigger 2 / Tach Response 2
- Cycle Length 1
- Cycle Length 2

NOTE: Programming the Scale Factor resets the Circular Offset to zero and sets the Cycle Length to the Scale Factor value. Programming Cycle Length 1 erases all limit setpoints for outputs 1 - 4. Programming Cycle Length 2 erases all limit setpoints for outputs 5 - 8.

When using this instruction, the parameters for both transducers must be written to the 2742-18. This is true even if only one parameter is being changed.

Example:

Set the following parameters:

- Scale Factor 1 to 3600
- Circular Offset 1 to 90
- Circular Offset 2 to 45
- Input Polarity 1 / Output Trigger 1 to Negative Polarity, Edge Triggered
 - The present Scale Factor 2 = 720
 - The present Tach Response 1 = 60 milliseconds
 - The present Input Polarity 2 / Output Trigger 2 = Positive, Level Triggered
 - The present Tach Response 2 = 240 milliseconds, 0.1 RPM resolution

Command Word:	A807h
Data Words:	3600h Scale Factor 1
	0720h Scale Factor 2
	0090h Circular Offset 1
	0045h Circular Offset 2
	0201h Input Polarity 1 / Output Trigger 1 / Tach Response 1
	0104h Input Polarity 2 / Output Trigger 2 / Tach Response 2

Backplane Programming Error Codes

The 2742-18 adds onto one error code and introduces two new ones.

The 2742-18 will issue an error message if you attempt to program a through zero limit. (The ON Setpoint greater than the OFF Setpoint.) The error is 'Invalid OFF Setpoint'. The 2742-18 will issue an 'Invalid ON Setpoint' or 'Invalid OFF Setpoint' error if the setpoint exceeds the corresponding Cycle Length parameter.

If you program an invalid Input Polarity / Output Trigger byte the 2742-18 will issue an 'Invalid IP/OT Byte' error. The error code is 45h for channel one and 55h for channel two.

If you program an invalid Cycle Length parameter byte the module will issue an 'Invalid Cycle Length' error. The error code is 43h for channel one and 53h for channel two.

Input Hardware Connections

This section covers how to wire sensors to the inputs. Wiring of the outputs is covered in the 2700 User Manual. Refer to Print B1162, page P-9 of the 2700 User Manual for output connections.

! CAUTION

Changes were made to the input circuit in order to accommodate two inputs on the limit switch connector. Instead of a single, totally isolated input, the 2742-18 has two inputs that have one side attached to the power supply common for the outputs. Therefore, these inputs are DC inputs only. **Do Not apply AC voltage to the input.**

NOTE: In order to react to an input transition as fast as possible, the inputs to the 2742-18 are not debounced. Therefore, use only shielded cable when connecting the material sensors to the modules' inputs. The shield of the cable must be connected to chassis ground as close to the sensors' power supply as possible. Tie the shields to ground at only one point.

Equivalent Circuit

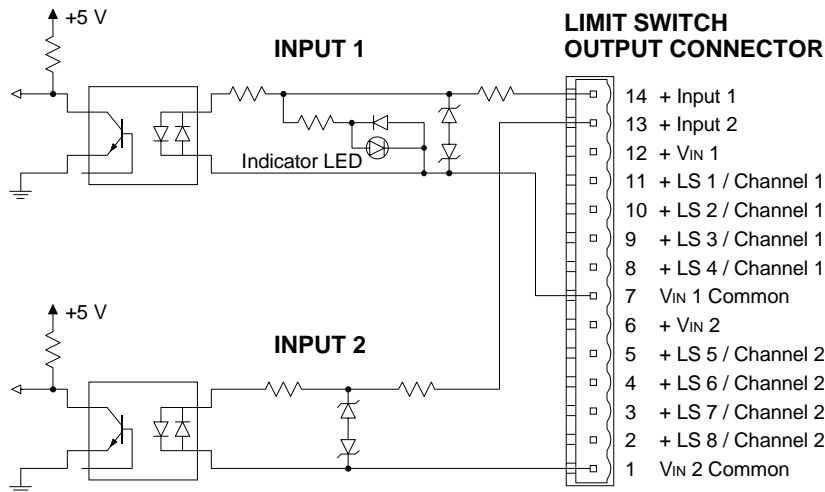

Input Voltage Specifications

Logic 1 Voltage	10 to 24 Vdc @ 10 mA (min.)	TON (max.)	3 milliseconds
Logic 0 Voltage	0 to 3 Vdc	TOFF (max.)	3 milliseconds

Appendix A 2742-18 Additional Instructions

Input Hardware Connections (continued)

Hookup to DC Source Output Sensors

The preferred material sensor is one with a DC Source output. The diagram below show how to connect a three wire sensor to the 2742-18. For simplicity, the diagram assumes that the power supplies used by the material sensors also drive the limit switch loads. These supplies are connected between the +VIN and VIN Common terminals.



A separate supply can be used by the sensor. However, the sensor supply and the limit switch supply *MUST* have a common ground. This is because the Inputs' circuitry and limit switch drivers are internally connected to VIN Common on the output connector.

THREE WIRE SOURCE SENSOR HOOKUP

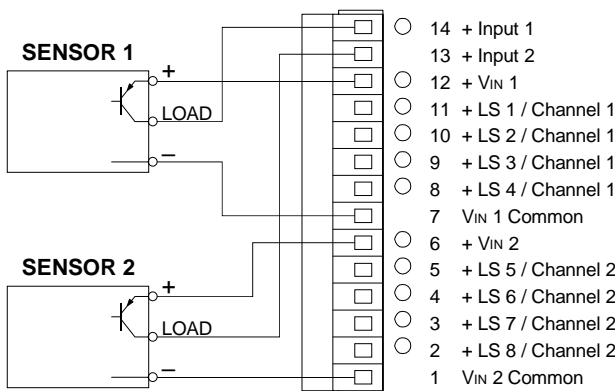

Note: The saturation voltage of the sensor cannot exceed 2Vdc @ 10 mA if you use 12Vdc to power the material sensor.

Note: The maximum allowable off state leakage current of the sensor is 500µA.

Hookup to DC Sink Output Sensors

The diagram below show how to connect a three wire sink output sensor to the 2742-18. The sensor must be able to sink a minimum of 60 mA and have a saturation voltage less than 3 Vdc at 60 mA. The external resistor must be supplied by the user. For simplicity, the diagram assumes that the power supplies used by the sensors also drive the limit switch loads. These supplies are connected between the +VIN and VIN Common terminals.

The **CAUTION** statement above also applies when using sink output sensors.

THREE WIRE SINK SENSOR HOOKUP

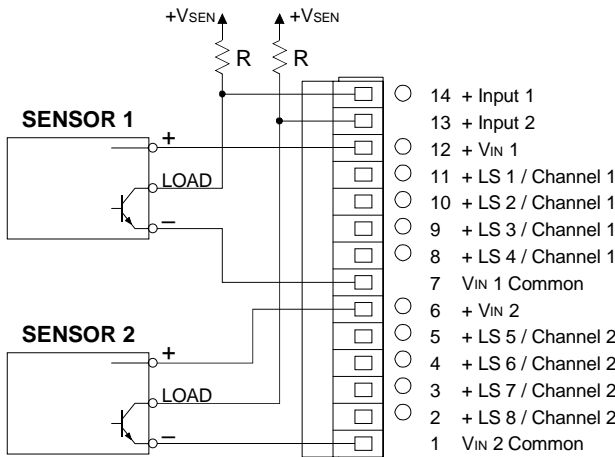

+VSEN	Value of Resistor 'R'
12 Vdc	200 Ω
15 Vdc	250 Ω
24 Vdc	400 Ω

Using the 2742-18 with a Single Transducer

Even though designed to work as a two channel PLS, the 2742-18 can work with a single transducer with few wiring modifications.

Transducer Connections

Like the standard 2742, you cannot program the 2742-18 from the backplane when the module has a transducer fault. (The module responds with a *Message Ignored* if you try.) Therefore, you must bring the single transducer into both channels. The figure below shows the two jumpers that must be installed on the MS-8 connector.

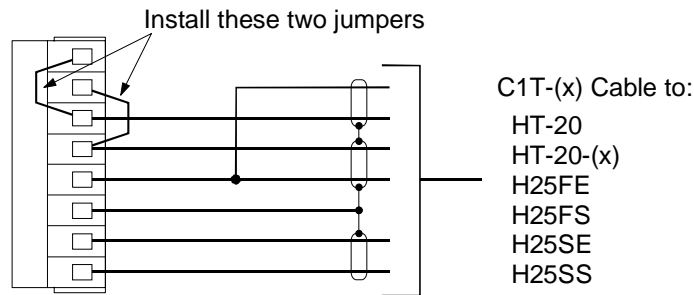

Material Sensor Connections

You can feed one material sensor into both inputs if you need all eight outputs on the single channel. However you must comply with the following guidelines.

- A source output sensor must be able to supply 20 mA. If you use 12 Vdc to power the sensor, the saturation voltage of the sensor cannot exceed 2 Vdc @ 20 mA.
- If you use separate power supplies for the sensor, LS1-4 and LS5-8, they **MUST** all have a common ground. This is because the Inputs' circuitry and limit switch drivers are internally connected to VIN Common on the output connector.



ADVANCED MICRO CONTROLS INC.

20 GEAR DRIVE, TERRYVILLE, CT 06786 T: (860) 585-1254 F: (860) 584-1973

www.amci.com



Waste Electrical and Electronic Equipment (WEEE)

At the end of life, this equipment should be collected separately from any unsorted municipal waste.